



Zündspulen / Zündmodule  
 Ignition Coils / Ignition modules  
 Bobines d'allumage / Module d'allumage  
 Bobines / Ontstekingsmodule  
 Bobinas de encendido / Módulos de encendido  
 Bobine di accensione / Moduli di accensione  
 Катушки зажигания / Модули системы зажигания  
 Cewki zapłonowe / Moduły zapłonowe  
 Πηνία ανάφλεξης / Συγκροτήματα ανάφλεξης  
 Gyújtótekercse / Gyújtómodulok  
 Bibine de ignição / Módulo de igniçã  
 Ateşleme bobinleri / Ateşleme modülleri

2013-2014





<p>Neu im Katalog New in the catalogue Nouveau dans le catalogue</p>	<p>Nieuw in de catalogus Nuevo en el catálogo Novità del catalogo</p>	<p>Новинка в каталоге Nowość w katalogu Νέα προϊόντα στον κατάλογο</p>	<p>Új a katalógusban Novo no catálogo Katalogda yeni</p>	<p>26</p>
				<p>36</p>
				<p>191</p>
				<p>195</p>
				<p>196</p>
<p><b>Technische Information</b> <b>Technical report</b> <b>Informations techniques</b> <b>Technische informatie</b> <b>Información técnica</b> <b>Informazione tecnica</b> <b>Техническая информация</b> <b>Informacje techniczne</b> <b>Τεχνικές πληροφορίες</b> <b>Műszaki adatok</b> <b>Informações técnicas</b> <b>Teknik bilgiler</b></p>				<p>200</p>
				<p>212</p>
				<p>256</p>
				<p>259</p>
				<p>261</p>
<p>Herstellerbezogene Sortimente Product ranges acc. to manufacturer Assortiments en fonction du fabricant Fabrikantgerelateerde sortimenten</p>	<p>Surtidos clasificados por marcas Assortimenti riferiti ai produttori Assortiment в соответствии с изготовителем Asortymen w odniesieniu do producentów</p>	<p>Γκάμα προϊόντων του κατασκευαστή Gyártófüggő választékok Sortidos ordenados por fabricantes Üreticiyi baz alan çeşitler</p>		<p>262</p>
<p>Ersatztypen Cross reference list Types de remplacement</p>	<p>Reservetypen Tipos de recambio Sistemi di vendita</p>	<p>Запасные типы Zamienniki Ανταλλακτικοί τύποι</p>	<p>Póttípusok Modelos de substituição Yedek tipler</p>	<p>265</p>
				<p>266</p>
				<p>284</p>
<p>Ausgabe <b>13/14</b></p>	<p>Mit Erscheinen dieser Ausgabe werden alle seitherigen Ausgaben ungültig. With the publication of this issue, all previous issues become invalid. Cette nouvelle édition rend caduques les éditions précédentes</p>	<p>Met het verschijnen van deze uitgave worden alle voorgaande uitgaven ongeldig Con la publicación de esta edición pierden su validez todas las ediciones publicadas hasta ahora. Con la comparsa della presentazione tutte le edizioni precedenti non sono più valide.</p>	<p>С опубликованием данного издания все предыдущие издания теряют силу. Wraz z ukazaniem się niniejszego wydania wszystkie poprzednie tracą ważność. Με την κυκλοφορία της παρούσας έκδοσης ακυρώνονται όλες οι προηγούμενες εκδόσεις.</p>	<p>Ennek a kiadásnak a megjelenése val az összes korábban közzétett adat elveszti érvényességét. Com o surgimento desta edição, todas as anteriores deixam de ser válidas Bu baskının yayımlanması ile birlikte önceki tüm baskılar geçerliliğini kaybeder.</p>

# Zündspulen: Volles Programm voller Umsatzpotential

BERU liefert über 400 Zündspulentypen – für mehr als 6.800 verschiedene Fahrzeugmodelle. Das gibt Sicherheit im Wartungs- und Reparaturgeschäft.

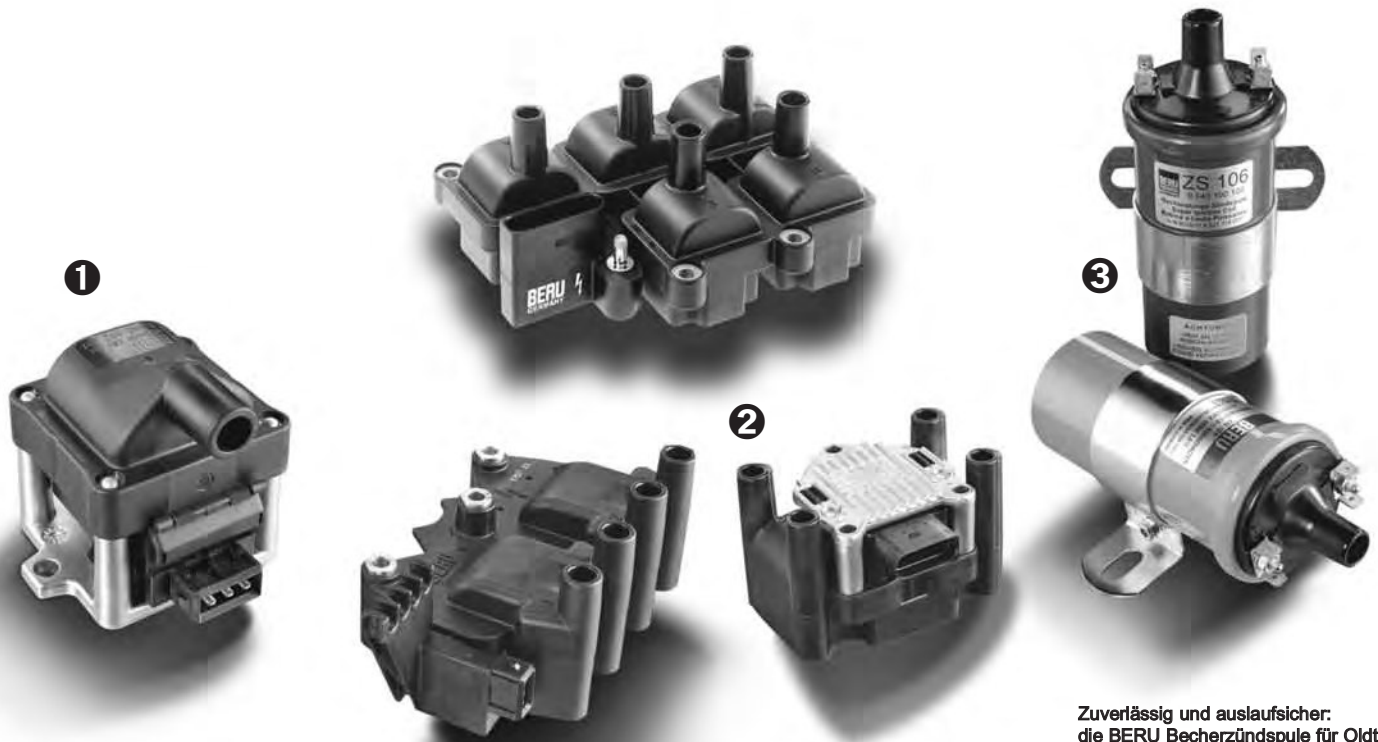

BERU Verteilerzündspule – mit integrierter Endstufe für rotierende Hochspannungsverteilung bei Fahrzeugmodellen von VW / Audi

BERU Blockzündspulen für gängige Fahrzeugmodelle von BMW, Fiat, Renault und VW.

Zuverlässig und auslaufsicher: die BERU Becherzündspule für Oldtimer.

Zur Senkung von Kraftstoffverbrauch und Emissionen und zur Effizienzsteigerung werden die Motorentechnologien immer weiter optimiert – und damit auch die Zündsysteme. BERU ist der Zündungsexperte. In der Sortimentsbreite bedeutet das: BERU liefert nicht nur Zündkerzen, sondern den kompletten Zündungsstrang, von Zündspulen und Zündkabeln über Stecker und Verteilerkappen bis zu Zündmodulen. Alles aus einer Hand. So wird das BERU Zündspulen-Programm permanent weiterentwickelt und ergänzt: BERU beliefert nahezu alle relevanten Volumen Anwendungen der europäischen Fahrzeughersteller – und bietet dem Wartungs- und Reparaturmarkt die entsprechend passende Type in kompromissloser Erstausrüstungsqualität. So können alleine in Europa über 130 Mio. zugelassene Benzinmotor mit BERU Zündspulen bestückt werden. Hier ein kurzer Überblick über die verschiedenen Zündspulenarten, die BERU im Programm hat.

## 1 Verteilerzündspule

Bei Zündspulen mit Zündverteiler gelangt die erzeugte Hochspannung von der Zündspule in den Zündverteiler. Der Zündverteiler verteilt diese Hochspannung an die entsprechenden Zündkerzen.

## 2 Blockzündspulen

In einer Blockzündspule sind mehrere Zündspulen zusammengefasst und steuern mehrere Zündkerzen über Zündleitungen an. Blockzündspulen gibt es mit und ohne integrierter Endstufe und in Einzel- oder Doppelfunkentechnik.

## 3 Becherzündspulen

Becherzündspulen kommen vor allem bei älteren Fahrzeugmodellen zum Einsatz. Auch hier empfiehlt sich der



Unterschiedliche Ausführungen von Kerzenschacht-/Steckerzündspulen für Fahrzeugmodelle von BMW, Fiat, Mercedes-Benz, Porsche, Renault oder VW.

BERU Zündspulenleisten für gängige Fahrzeuge von VW, Opel, Peugeot, Citroën und Škoda.



Einbau von Original BERU Markenzündspulen: Denn diese bieten durch die trockene und damit auslaufsichere Isolierung zwischen Spulenwicklung und Bechergehäuse deutlich mehr Sicherheit. Die von Billiganbietern gefertigten Becherzündspulen sind oftmals mit Öl gefüllt – das bei einem Defekt oder Unfall auslaufen und zu einem Fahrzeugbrand führen kann.

#### 4 Kerzenschacht-/Steckerzündspulen

Kerzenschacht- oder Steckerzündspulen (mit Einzel- und Doppelfunktentechnik) werden direkt auf die Zündkerze aufgesteckt. Dadurch kann die Zündenergie praktisch ohne Leistungsverluste direkt an die Zündkerze übertragen werden. Weiterer Vorteil: Der bereits vorhandene Zündkerzenschacht kann, je nach Bauform als Montageraum für die Zündspule genutzt werden. Kerzenschacht- und Steckerzündspulen werden in Fahrzeugen mit vollelektronischer Zündung eingesetzt.

#### 5 Zündspulenleisten

In einer Zündspulenleiste sind mehrere Einzelzündspulen zusammengefasst. Diese werden direkt auf die Zündkerzen gesteckt. Zur frühzeitigen Erkennung von Fehlzündungen, klopfender Verbrennung und Zündaussetzern können die Spulen außerdem mit einer integrierten Ionenstrommessung ausgestattet sein, die die optimale Gemischverbrennung überwacht. BERU Zündspulenleisten werden zum Beispiel von VW, Opel, Peugeot, Citroën und Škoda verbaut.

## Ignition coils: Full range, full sales potential

BERU supplies over 400 ignition coil types – for more than 6,800 different vehicle models. This ensures reliability in the maintenance and repair business.



BERU distributor ignition coil – with integrated end-stage for rotating high-voltage distribution in vehicle models VW / Audi.

BERU block ignition coils for conventional vehicle models BMW, Fiat, Renault and VW.

Reliable and leak-proof: the BERU canister type ignition coils for Oldtimer.

To reduce fuel consumption and emissions and increase efficiency, engine technology is being ever more optimised – and therefore ignition systems as well. BERU is the spark plug specialist. In width of product range terms this means: BERU not only supplies spark plugs, it also provides the entire ignition train – from ignition coils and ignition leads to plugs and distributor caps and ignition modules. Everything from a single source. The BERU ignition coil range is permanently further developed and supplemented in this way: BERU supplies practically all relevant volume applications of European vehicle manufacturers – and offers the maintenance and repair market the appropriate type in uncompromising OEM quality. This means that in Europe, over 130 million registered petrol vehicles can be fitted with BERU ignition coils. Here is a brief overview of the various ignition coil types in the BERU range.

### 1 Distributor ignition coil

In the case of ignition coils with an ignition distributor the generated high voltage goes from the ignition coil into the ignition distributor. The ignition distributor distributes this high voltage to the corresponding spark plugs.

### 2 Block ignition coils

A block ignition coil combines several ignition coils and controls several spark plugs via ignition leads. There are block ignition coils with and without integrated end stage and which utilize single or dual spark technology.

### 3 Canister-type ignition coils

Canister-type ignition coils are mainly used in older vehicle models. Here, too, the installation of original BERU branded



4 Various designs of plug shaft/connector ignition coils for new vehicle models BMW, Fiat, Mercedes-Benz, Porsche, Renault or VW.

BERU ignition coil rails for conventional vehicles from VW, Opel, Peugeot, Citroën and Škoda.



ignition coils is recommended: because they are much safer because of the dry and leak-proof insulation between the coil winding and the housing. The canister-type ignition coils manufactured by suppliers of cheap products are often filled with oil – which can leak in the event of a fault or accident and result in a vehicle fire.

#### 4 Plug shaft/connector ignition coils

Plug shaft or connector ignition coils (utilizing single and dual spark technology) are inserted directly into the spark plug. As a result, the ignition energy can be transmitted directly to the spark plug with practically no power losses. Other advantages are: The existing spark plug shaft, depending on its design, can be used as mounting space for the ignition coil. Plug shaft or connector ignition coils are used in vehicles which feature fully electronic ignition.

#### 5 Ignition coil rails

Several individual ignition coils are brought together in an ignition coil rail. They are then plugged directly onto the spark plugs. For the early detection of false firing, knocking and misfiring, the coils can also be fitted with an integral ionic current measurement that monitors the optimum mixture combustion. BERU ignition coils are installed for example by VW, Opel, Peugeot, Citroën and Škoda.

# Bobines d'allumage : tout un programme pour exploiter pleinement votre potentiel de chiffre d'affaires

BERU livre plus de 400 types de bobine d'allumage – pour plus de 6 800 modèles de véhicule différents. Vos travaux d'entretien et de réparation peuvent ainsi se faire en toute sécurité.

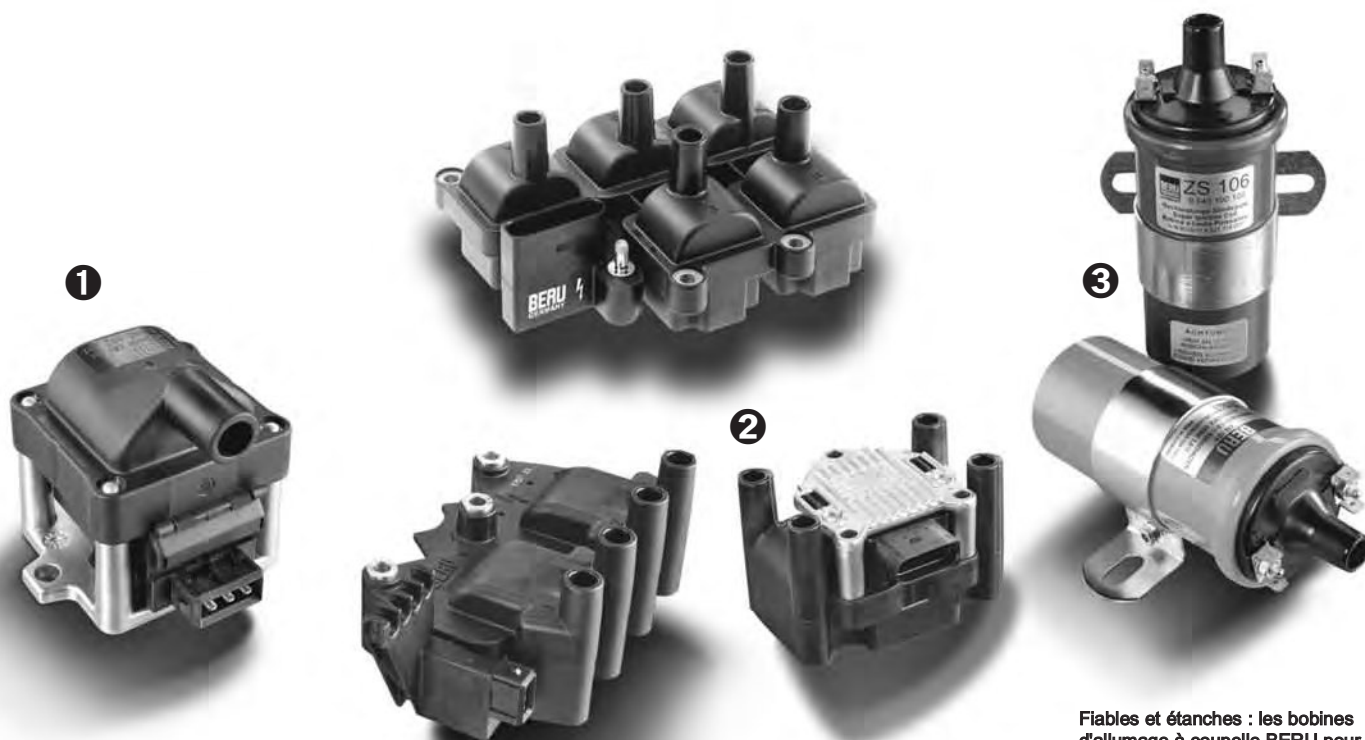

Bobine d'allumage de distribution BERU – avec étage final intégré pour la distribution rotative de haute tension sur les modèles de véhicule VW / Audi

Bobines d'allumage blocs BERU pour les modèles de véhicule courants de BMW, Fiat, Renault et VW.

Fiables et étanches : les bobines d'allumage à coupelle BERU pour voitures anciennes.

Afin de réduire la consommation de carburant et les émissions et afin d'augmenter l'efficacité, les technologies des moteurs sont constamment optimisées – et les systèmes d'allumage par la même occasion. BERU est l'expert de l'allumage. Ceci se traduit dans la largeur de l'assortiment par : BERU ne fournit pas seulement des bougies d'allumage mais la chaîne complète d'allumage – des bobines et câbles d'allumage en passant par les connecteurs et les têtes d'allumeur jusqu'aux modules d'allumage. Tout chez un seul et même fournisseur. Ainsi, le programme des bobines d'allumage BERU évolue et est complété en permanence : BERU livre quasiment tous les volumes pertinents pour les constructeurs automobiles européens – et fournit toujours le type requis au marché de l'entretien et des réparations avec une qualité de première monte sans aucun compromis. Rien qu'en Europe, plus de 130 mio. de véhicules à moteur essence immatriculés peuvent ainsi être équipés de bobines d'allumage BERU. Voici un bref aperçu des différents types de bobine d'allumage compris dans le programme de BERU.

## 1 Bobine d'allumage de distribution

Sur les bobines d'allumage à distributeur d'allumage, la haute tension générée est acheminée vers le distributeur d'allumage depuis la bobine d'allumage. Le distributeur d'allumage distribue cette haute tension aux bougies d'allumage correspondantes.

## 2 Bobines d'allumage blocs

Une bobine d'allumage bloc regroupe plusieurs bobines d'allumage qui commandent plusieurs bougies d'allumage via des câbles d'allumage. Les bobines d'allumage blocs sont disponibles avec ou sans étage final intégré et à étincelle unique ou à double étincelle.

## 3 Bobines d'allumage à coupelle

Les bobines d'allumage à coupelle sont surtout utilisées sur les modèles de véhicules plus anciens. Le montage de bobines d'allumage de marque d'origine BERU est égale-





Différents modèles de bobines d'allumage à fût de bougie / avec embout pour les modèles de véhicules de BMW, Fiat, Mercedes-Benz, Porsche, Renault ou VW.



Barres de bobines d'allumage BERU pour les véhicules courants de VW, Opel, Peugeot, Citroën et Škoda.

ment recommandé pour ces modèles : car ces dernières offrent une sécurité nettement plus élevée grâce à l'isolation sèche et donc sans fuite entre l'enroulement de la bobine et le boîtier de la coupelle. Les bobines d'allumage bon marché sont souvent remplies d'huile – qui risque de fuir en cas de défaut ou d'accident et d'entraîner un incendie de véhicule.

- 4 Bobines d'allumage à fût de bougie / avec embout**  
Les bobines d'allumage à fût de bougie ou avec embout (à étincelle unique ou à double étincelle) s'emboîtent directement sur la bougie d'allumage. Ainsi, l'énergie d'allumage peut être transmise à la bougie d'allumage quasiment sans pertes de puissance. Autre avantage : le fût de bougie préexistant peut être utilisé comme espace de montage pour la bobine d'allumage selon sa forme. Le fût de bougie et les bobines d'allumage à embout sont utilisés dans les véhicules à allumage entièrement électronique.

- 5 Barres de bobines d'allumage**  
Une barre de bobines d'allumage regroupe plusieurs bobines d'allumage individuelles. Celles-ci s'emboîtent directement sur la bougie d'allumage. Afin de détecter rapidement les problèmes d'allumage, la combustion détonante et les ratés d'allumage, les bobines peuvent par ailleurs être équipées d'un dispositif de mesure intégré du courant ionique. Les barres de bobines d'allumage BERU sont par exemple utilisées par VW, Opel, Peugeot, Citroën et Škoda.

# Bobines: volledig programma, volledig omzetspotentieel

BERU levert meer dan 400 soorten bobines voor meer dan 6.800 verschillende voertuigmodellen. Dat zorgt voor zekerheid in de onderhouds- en reparatiehandel.

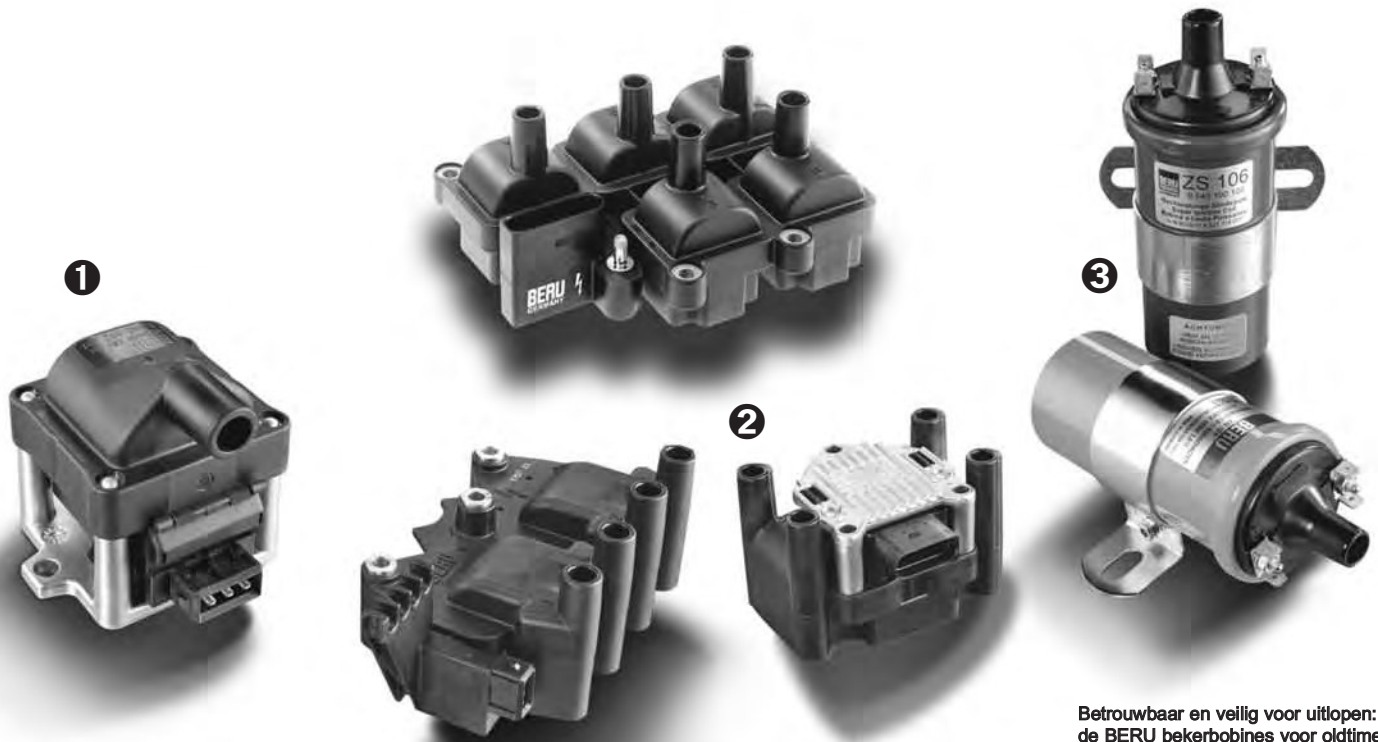

BERU verdelerbobines met geïntegreerde eindtrap voor roterende hoogspanningsverdeling bij voertuigmodellen van VW / Audi

BERU blokbobines voor gebruikelijke voertuigmodellen van BMW, Fiat, Renault en VW.

Betrouwbaar en veilig voor uitlopen: de BERU bekerbobines voor oldtimers.

Voor het verlagen van het brandstofverbruik en emissie en voor de verhoging van de efficiëntie wordt de motorentechnologie steeds verder geoptimaliseerd- en daardoor ook de ontstekings-systemen. BERU is de ontstekingsexpert. Voor het sortiments-spectrum betekent dat: dat BERU niet alleen bougies levert maar het hele ontstekingspectrum, van bobines en ontstekingskabels via stekkers en verdelerkappen tot aan ontstekingsmodules. Alles van een firma. Zo wordt het BERU bobineprogramma permanent verder ontwikkeld en gecompleteerd: BERU levert aan bijna alle relevante volumetoepassingen van de Europese voertuigfabrikanten en biedt de onderhouds- en reparatiemarkt het desbetreffende type in compromisloze proefmodelkwaliteit. Zo kunnen er in Europa meer dan 130 miljoen toegelaten benzine-auto's met BERU bobines worden uitgerust. Hier volgt een kort overzicht van de verschillende soorten bobines die BERU in het programma heeft.

## 1 Verdelerbobine

Bij bobines met ontstekingsverdeler komt de gegenereerde hoogspanning van de bobine in de ontstekingsverdeler. De ontstekingsverdeler verdeelt deze hoogspanning over de betreffende bougies.

## 2 Blokbobines

In een blokbobine zijn meerdere bobines samengevat die meerdere bougies via ontstekingsleidingen besturen. Blokbobines zijn er met of zonder geïntegreerde eindtrap en in de techniek met enkele of dubbele vonken.

## 3 Bekerbobines

Bekerbobines worden vooral toegepast bij oudere voertuigmodellen. Ook hier wordt de montage van originele BERU merkbobines aanbevolen. Want deze bieden door de



4  
Verschillende uitvoeringen van staaf-/stekkerbobines voor voertuigmodellen van BMW, Fiat, Mercedes-Benz, Porsche, Renault of VW.

BERU bobinrails voor gebruikelijke voertuigen van VW, Opel, Peugeot, Citroën en Škoda.



droge en zodoende uitloopveilige isolatie tussen spoelwikkeling en bekerbehuizing duidelijk meer veiligheid. De door goedkopere aanbieders vervaardigde bekerbobines zijn vaak met olie gevuld en kunnen bij een defect uitlopen en tot een voertuigbrand leiden.

#### 4 Staaf-/stekkerbobines

Staa- of stekkerbobines (met enkele of dubbele vonkentechniek) worden direct op de bougie gestoken. Daardoor kan de ontstekingsenergie bijna zonder prestatieverlies direct aan de bougie worden overgedragen. Nog een voordeel: de reeds aanwezige bougieschacht kan naar gelang de bouwvorm als montagekamer voor de bobine worden gebruikt. Staa- en stekkerbobines worden gebruikt in voertuigen met volelektronische ontsteking.

#### 5 Bobinrails

In een bobinrail zijn meerdere afzonderlijke bobines samengevat. Deze worden direct op de bougies gestoken. Voor de vroegtijdige detectie van foute ontstekingen, kloppende verbranding en ontstekingsuitvalen kunnen de bobines bovendien met een geïntegreerde ionenstroommeting zijn uitgerust die de optimale mengselverbranding bewaakt. BERU bobinrails worden bijvoorbeeld door VW, Opel, Peugeot, Citroën en Škoda ingebouwd.

## Bobinas de encendido: Programa completo, potencial de ventas completo

BERU suministra 400 tipos de bobinas de encendido para más de 6.800 modelos de vehículos diferentes. Eso proporciona seguridad al negocio del mantenimiento y la reparación.

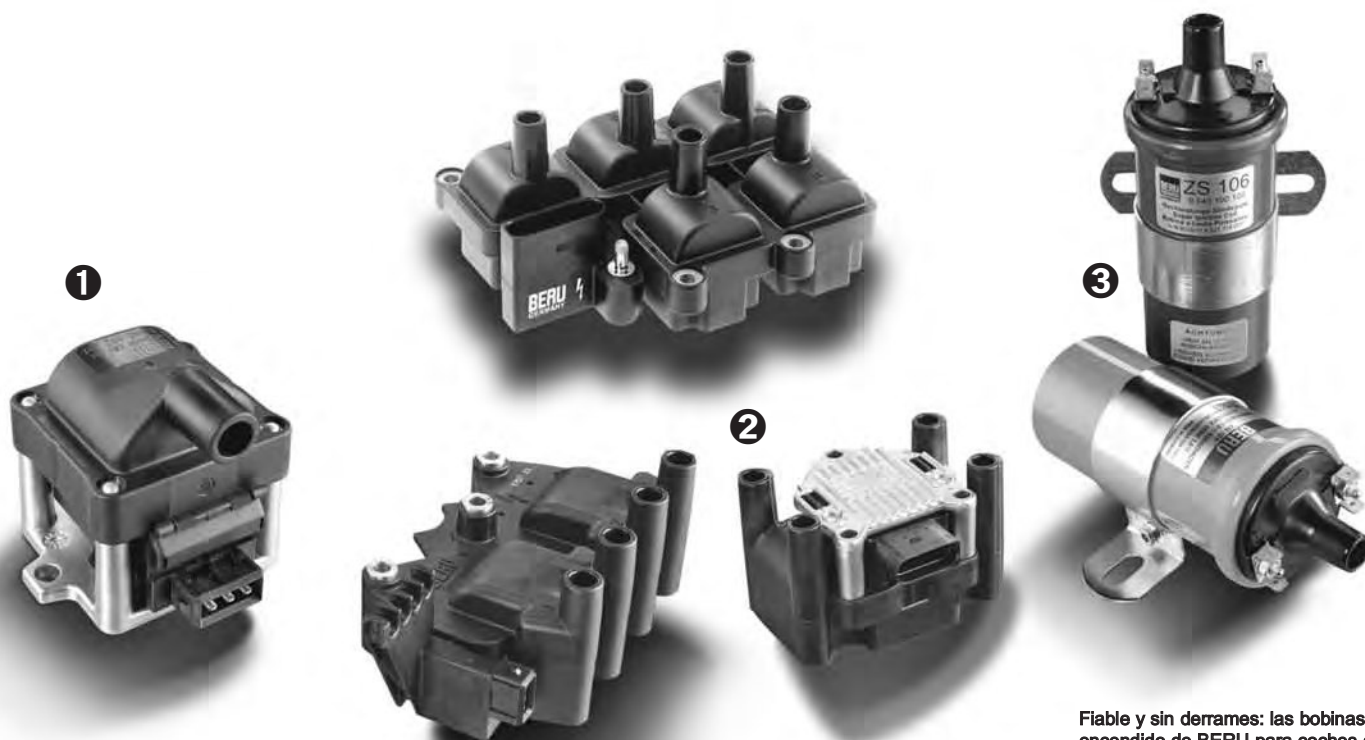

**1** Bobina de encendido con distribuidor de BERU con fase final integrada para distribución rotativa de alta tensión en modelos de vehículos de VW y Audi

**2** Bobinas de encendido de bloque de BERU para los modelos de vehículos más vendidos de BMW, Fiat, Renault y VW.

**3** Fiable y sin derrames: las bobinas de encendido de BERU para coches de época.

Para reducir el consumo de combustible y de emisiones y para un incremento de la eficiencia, la tecnología del motor se optimiza cada vez más, y por eso también el sistema de encendido. BERU es el experto en encendido. Para la amplitud del surtido esto significa que: BERU no sólo suministra bujías de encendido, sino la fase de encendido completa, desde bobinas y cables de encendido pasando por conectores y tapas del distribuidor hasta los módulos de encendido. Todo de una única procedencia. Por eso el programa de encendido de bobinas de BERU está en continuo proceso de estudio y ampliación: BERU cubre prácticamente todas las aplicaciones relevantes de los fabricantes de automóviles europeos, y ofrece al mercado del mantenimiento y la reparación los tipos adecuados correspondientes a una calidad de primer equipo sin compromisos. Por eso, solamente en Europa, es posible abastecer de 130 millones de motores de gasolina con las bobinas de encendido BERU. Aquí encontrará un pequeño resumen sobre los diferentes tipos de bobinas de encendido que BERU incluye en su programa.

### **1** Bobina de encendido con distribuidor

En bobinas de encendido con distribuidor de encendido se alcanza la alta tensión de la bobina de encendido en el distribuidor de encendido. El distribuidor de encendido distribuye esta alta tensión entre las correspondientes bujías de encendido.

### **2** Bobinas de encendido en bloque

En una bobina de encendido en bloque se agrupan más de una bobina de encendido y controlan varias bujías de encendido a través de los cables de encendido. Las bobinas de encendido están disponibles con o sin fase final integrada y en radiotécnica doble o simple.

### **3** Bobinas de encendido de cartucho

Las bobinas de encendido de cartucho se utilizan sobre todo en modelos de vehículos más antiguos. También aquí se recomienda el montaje con bobinas de encendido de



4

Distintos modelos de bobinas de encendido receptáculo de las bujías / bobinas independientes por cilindro destinadas a los modelos de vehículos de BMW, Fiat, Mercedes-Benz, Porsche, Renault o VW.

marca BERU Original: estas ofrecen claramente más seguridad, gracias al aislamiento seco y libre de derrames entre la bobina de alambre y la carcasa del cartucho. Las bobinas de encendido de cartucho fabricadas con materiales de bajo precio, a menudo, se llenan con aceite. Esto puede acabar provocando defectos o accidentes y provocar un incendio en el vehículo.

#### 4 Bobinas de encendido para el receptáculo de las bujías / bobinas independientes por cilindro

Las bobinas de encendido para el receptáculo de las bujías o bobinas independientes por cilindro (con radiotécnica doble o simple) se conectan directamente en las bujías de encendido. De esta manera, la energía de encendido se puede transmitir directamente a la bujía de encendido prácticamente sin pérdidas de potencia. Otra ventaja: El receptáculo de la bujía ya existente se puede utilizar, según el modelo, como espacio de montaje para la bobina de encendido. Las bobinas de encendido para el receptáculo de las bujías y bobinas independientes por cilindro se instalan en vehículos con encendido completamente electrónico.

Regletas de bobinas de encendido de BERU para los modelos de vehículos más vendidos de VW, Opel, Peugeot, Citroën y Škoda.



5

#### 5 Regletas de bobinas de encendido

En una regleta de bobinas de encendido hay más bobinas individuales agrupadas. Estas se conectan directamente en las bujías de encendido. Para la detección prematura de anomalías de encendido, combustiones con detonaciones y fallos de encendido, las bobinas se pueden equipar además con un sistema de medición de corriente iónica integrado, que controla la combustión óptima. Las bobinas de encendido BERU se producen para la fabricación de, por ejemplo, VW, Opel, Peugeot, Citroën y Škoda.

## Bobine d'accensione: Un programma pieno di potenziale fatturato

La BERU fornisce oltre 400 tipi di bobine d'accensione - per oltre 6.800 differenti tipi di autoveicoli. Un fattore di sicurezza sia nel ramo della manutenzione che in quello della riparazione.

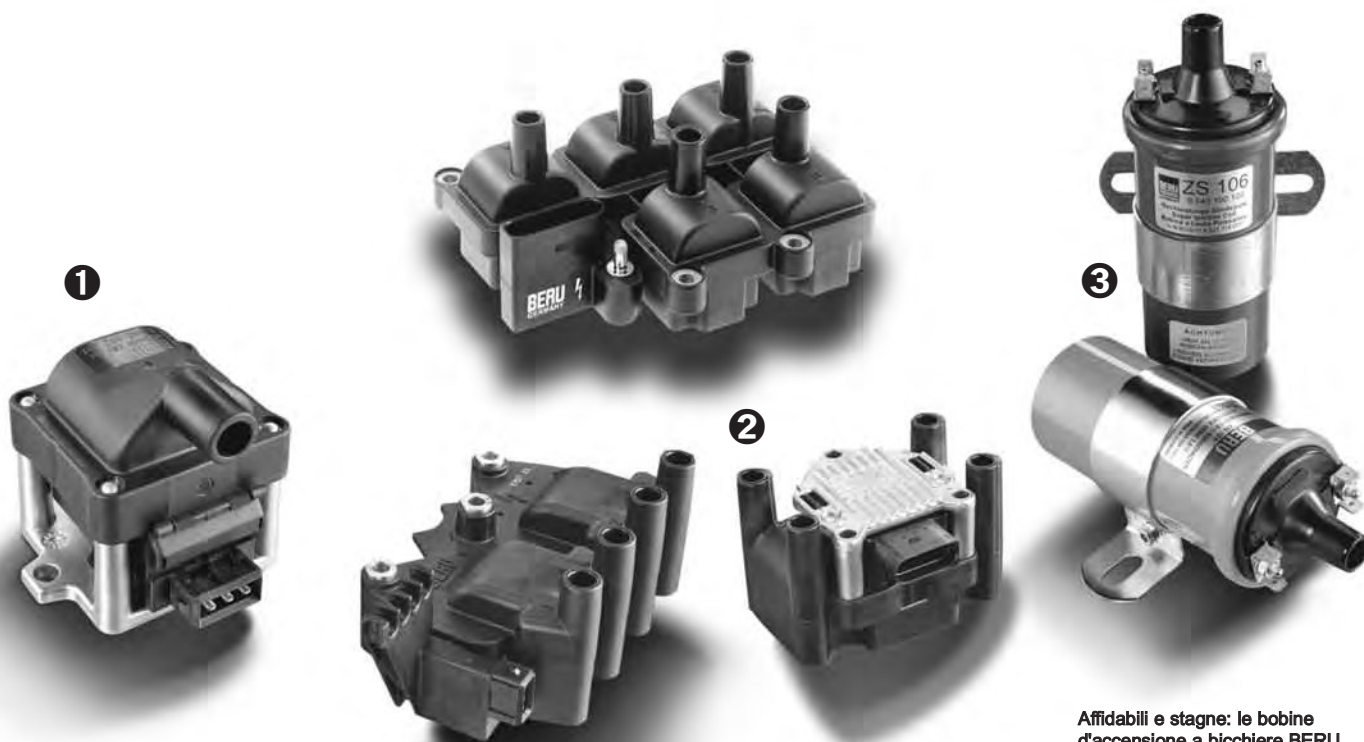

**1** Bobina d'accensione per spinterogeno BERU - con stadio finale integrato per distribuzione rotativa dell'alta tensione in modelli VW/Audi

**2** Bobine di accensione in blocco BERU per modelli di vetture attuali di BMW, Fiat, Renault e VW.

**3** Affidabili e stagne: le bobine d'accensione a bicchiere BERU per oldtimer.

Per la riduzione del consumo di carburante e delle emissioni come anche per l'innalzamento dell'efficienza, le tecnologie dei motori vengono sempre più ottimizzate - e con loro anche i sistemi di accensione. La BERU è un esperto in accensione. Nell'assortimento ciò significa: BERU non fornisce solo candele d'accensione, bensì la completa linea d'accensione - dalle bobine d'accensione e cavi d'accensione, spinotti e calotte spinterogeno, fino ai moduli d'accensione. Tutto da un'unica mano. Così, il programma di bobine d'accensione BERU continua ad essere sviluppato e completato: BERU fornisce quasi tutte le più importanti applicazioni di volume dei costruttori europei di automobili - offrendo al mercato della manutenzione e della riparazione il tipo adatto in perfetta qualità di prima fornitura. Così, già solo in Europa 130 milioni di vetture a benzina possono essere equipaggiate con bobine di accensione BERU. Ecco una breve panoramica dei differenti tipi di bobine di accensione offerte dalla gamma BERU.

- 1 Bobina di accensione per spinterogeno**  
Nelle bobine di accensione con spinterogeno l'alta tensione generata parte dalla bobina di accensione e arriva allo spinterogeno. Lo spinterogeno distribuisce quest'alta tensione alle relative candele d'accensione.
- 2 Bobine d'accensione in blocco**  
In una bobina d'accensione in blocco sono raggruppate più bobine d'accensione che comandano più candele d'accensione attraverso le linee di accensione. Le bobine d'accensione in blocco sono disponibili con e senza stadio finale integrato e in tecnica monoscintilla o a scintilla doppia.
- 3 Bobine d'accensione a bicchiere**  
Le bobine d'accensione a bicchiere si trovano soprattutto in modelli di vetture di una certa età. Anche qui si raccomanda il montaggio di bobine d'accensione di marca originali



4

Differenti esecuzioni di bobine di accensione per pozzetto candela e a spinotto per modelli di vetture di BMW, Fiat, Mercedes-Benz, Porsche, Renault o VW.

Barre per bobine d'accensione BERU per vetture comuni di VW, Opel, Peugeot, Citroën e Škoda.



5

BERU: esse offrono infatti, grazie al loro isolamento asciutto e stagno fra l'avvolgimento della bobina e l'alloggiamento a bicchiere, molta più sicurezza. Le bobine d'accensione a bicchiere offerte da produttori di prodotti a basso prezzo sono spesso riempite di olio - che in caso di difetto o di incidente può fuoriuscire causando l'incendio della vettura.

#### 4 Bobine d'accensione per pozzetto candela/a spinotto

Le bobine d'accensione per pozzetto candela o le bobine d'accensione a spinotto (con tecnica monoscintilla o a doppia scintilla) vengono innestate direttamente sulla candela. In tale maniera è possibile trasmettere l'energia di accensione praticamente senza perdite direttamente alla candela. Un ulteriore vantaggio: a seconda della sua forma, il pozzetto della candela già esistente può essere usato come posto di montaggio per la bobina d'accensione. Le bobine d'accensione per pozzetto candela e a spinotto vengono usate in vetture dotate di accensione completamente elettronica.

#### 5 Barre per bobine d'accensione

In una barra per bobina d'accensione sono raggruppate più bobine d'accensione. Esse vengono innestate direttamente sulle candele d'accensione. Per il riconoscimento anticipato di errori di accensione, di battiti in testa e di accensioni a singhiozzo le bobine possono essere inoltre dotate di un misuratore integrato di flusso di ioni, che sorveglia la combustione ottimale della miscela. Le bobine d'accensione BERU vengono montate per esempio in vetture di VW, Opel, Peugeot, Citroën e Škoda.

## Катушки зажигания: комплектная программа, значительный потенциал оборота

BERU поставляет свыше 400 типов катушек зажигания – для более чем 6.800 различных моделей автомобилей. Это обеспечивает надежность при техобслуживании и ремонте.



Катушки BERU с распределителем зажигания – с интегрированным выходным каскадом для вращающегося распределителя высокого напряжения в моделях автомобилей VW/Audi

Блочные катушки зажигания BERU для распространенных моделей автомобилей BMW, Fiat, Renault и VW.

Надежны и без протечки: корпусные катушки зажигания BERU для старых моделей автомобилей.

Для снижения расхода топлива и выбросов, а также для увеличения эффективности постоянно оптимизируются технологии двигателя, а тем самым и системы зажигания. Фирма BERU - специалист по системам зажигания. Применительно к объему ассортимента это означает: фирма BERU поставляет не только свечи зажигания, но также комплектную цепь зажигания - от катушек и кабелей зажигания, штекеров и крышек распределителей вплоть до модулей системы зажигания. Все из одних рук. Так программа катушек зажигания BERU непрерывно развивается и дополняется: BERU удовлетворяет практически все объемные доли поставок для важнейших европейских заводов-изготовителей транспортных средств – и предлагает рынку техобслуживания и запасных частей соответствующие типы изделий безукоризненного заводского качества. Это означает, что в Европе свыше 130 миллионов зарегистрированных бензиновых автомобилей могут быть оснащены катушками зажигания BERU. Ниже приведен краткий обзор различных катушек зажигания, имеющих в программе BERU.

- 1 Катушки с распределителем зажигания**  
При использовании катушек зажигания с распределителем созданное высокое напряжение попадает с катушки в распределитель зажигания. Тот распределяет это высокое напряжение по соответствующим свечам зажигания.
- 2 Блочные катушки зажигания**  
Блочная катушка зажигания состоит из нескольких отдельных катушек зажигания и управляет несколькими свечами зажигания через провода системы зажигания. Блочные катушки зажигания имеются с встроенным выходным каскадом и без него, а также с одинарным или двойным зажиганием.
- 3 Корпусные катушки зажигания**  
Корпусные катушки зажигания применяются в первую очередь в более старых моделях автомобилей. Здесь также рекомендуется использовать оригинальные





4

Катушки зажигания карандашного типа/штетерные катушки зажигания различных моделей для автомобилей BMW, Fiat, Mercedes-Benz, Porsche, Renault или VW.

катушки зажигания BERU: ибо они гарантируют высокую надежность благодаря сухой и тем самым неспособной к истечению изоляции между обмоткой катушки и корпусом стакана. Корпусные катушки зажигания, предлагаемые по низкой цене, часто наполнены маслом - оно может вытечь при неисправности или аварии и привести к возгоранию автомобиля.

#### 4 Катушки зажигания карандашного типа/штетерные катушки зажигания

Карандашные или штетерные катушки зажигания (с одинарным или двойным зажиганием) насаживаются прямо на свечу зажигания. Благодаря этому можно передать энергию зажигания практически без потерь мощности прямо на свечу зажигания. Другое преимущество: уже имеющееся гнездо свечи зажигания в зависимости от конструкции можно использовать для монтажа катушки зажигания. Катушки зажигания карандашного типа и штетерные катушки зажигания применяются в автомобилях с электронной системой зажигания без распределителя.

Колодки катушек зажигания BERU для распространенных моделей автомобилей VW, Opel, Peugeot, Citroën и Škoda.



5

#### 5 Колодки катушек зажигания

Колодка катушек зажигания состоит из нескольких отдельных катушек зажигания. Колодки насаживаются прямо на свечи зажигания. Для своевременного распознавания отказов в зажигании, горения с детонацией и перебоев в зажигании катушки можно кроме того оснащать интегрированным устройством измерения ионного тока, которое контролирует оптимальное сжигание смеси. Колодки катушек зажигания устанавливаются, например, в автомобилях VW, Opel, Peugeot, Citroën и Škoda.

## Cewki zapłonowe: Kompletny program, wielki potencjał sprzedaży

BERU posiada w swojej ofercie ponad 400 typów cewek zapłonowych – do ponad 6.800 różnych modeli pojazdów. Daje to pewność w branży napraw i serwisu.

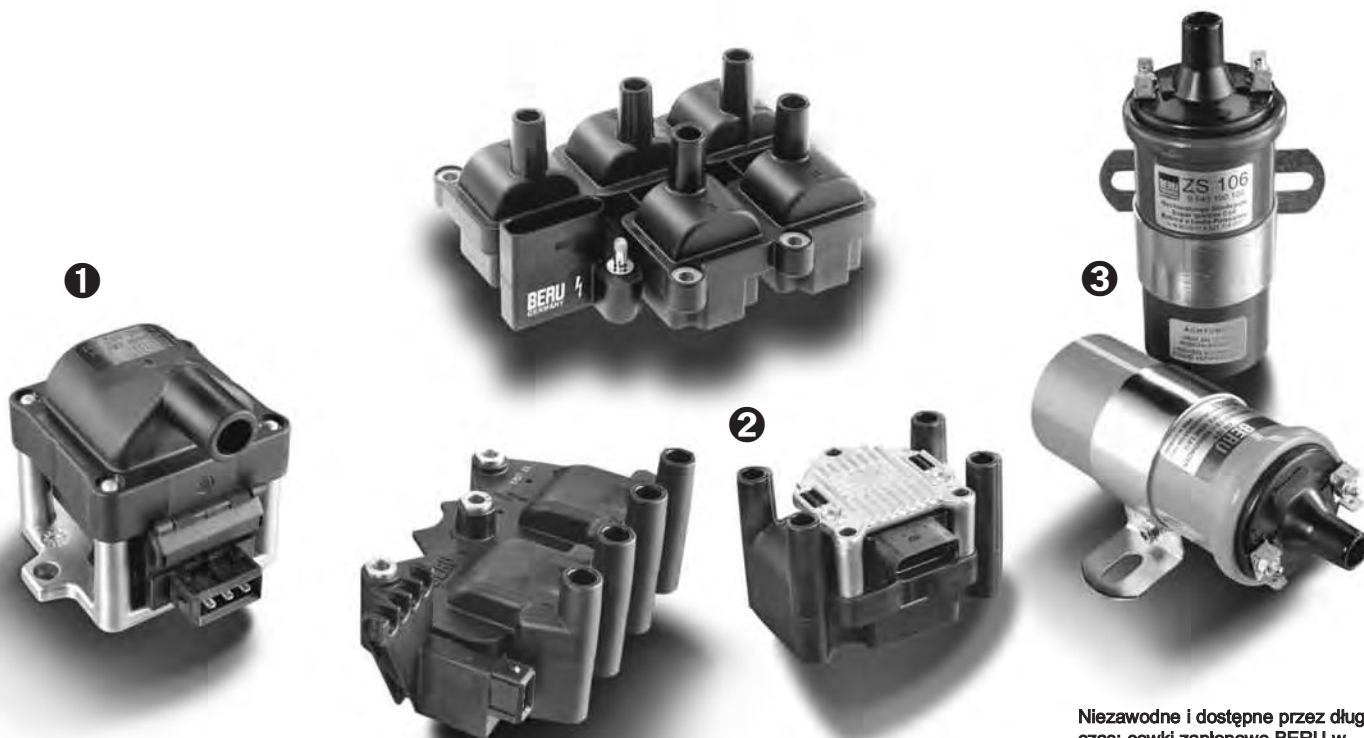

Cewka zapłonowa BERU z rozdzielaczem – ze zintegrowanym wzmacniaczem mocy do obrotowych rozdzielaczy wysokiego napięcia w modelach pojazdów VW/Audi.

Blokowe cewki zapłonowe BERU do popularnych modeli pojazdów marki BMW, Fiat, Renault i VW.

Niezawodne i dostępne przez długi czas: cewki zapłonowe BERU w obudowie walcowej do oldtimerów.

W celu obniżenia zużycia paliwa i emisji oraz wzrostu efektywności nieustannie postępuje optymalizacja technologii silników, a wraz z nią układów zapłonowych. BERU to specjalista w zakresie układów zapłonowych. BERU posiada w swojej ofercie nie tylko świece zapłonowe, lecz kompletne układy zapłonowe – od cewek i kabli zapłonowych, poprzez wtyczki i kopułki rozdzielacza po moduły zapłonowe. Kompleksowe rozwiązania. W wyniku tego BERU nieprzerwanie rozwija i uzupełnia program cewek zapłonowych: BERU dostarcza wyroby niemal dla wszystkich wielkoseryjnych pojazdów europejskich producentów samochodów oraz oferuje rynkowi napraw i serwisu odpowiednie pasujące typy wyrobów, które odznaczają się bezkompromisową jakością jak w fabrycznie w nowych pojazdach. Oznacza to, że w Europie do ponad 130 milionów zarejestrowanych pojazdów benzynowych można zamontować cewki zapłonowe BERU. Poniżej krótki przegląd różnych rodzajów cewek zapłonowych dostępnych w ofercie BERU.

### 1 Cewka zapłonowa z rozdzielaczem

W przypadku cewek zapłonowych z rozdzielaczem zapłonu wysokie napięcie przechodzi z cewki zapłonowej do rozdzielacza zapłonu. Rozdzielacz zapłonu rozdziela to wysokie napięcie na odpowiednie świece zapłonowe.

### 2 Blokowe cewki zapłonowe

Blokowa cewka zapłonowa zawiera kilka cewek zapłonowych, które poprzez przewody zapłonowe sterują kilkoma świecami zapłonowymi. Blokowe cewki zapłonowe są dostępne ze zintegrowanym wzmacniaczem mocy lub bez wzmacniacza, w wersji jedno- lub dwuiskrowej.

### 3 Cewki zapłonowe w obudowie walcowej

Cewki zapłonowe w obudowie walcowej występują przede wszystkim w starszych modelach pojazdów. Także tutaj zaleca się zamontowanie oryginalnych cewek zapłonowych



4

Różne wykonania indywidualnych/wtykowych cewek zapłonowych do pojazdów marki BMW, Fiat, Mercedes-Benz, Porsche, Renault i VW.

marki BERU: Ich sucha i niezagrożona wypłynięciem izolacja pomiędzy uzwojeniem cewek i obudową walcową zapewnia bowiem wyraźnie więcej bezpieczeństwa. Cewki zapłonowe w obudowie walcowej wykonane przez tańszych dostawców są wypełnione często olejem, który w razie awarii lub wypadku wycieka i może spowodować zapalenie pojazdu.

#### 4 Indywidualne/wtykowe cewki zapłonowe

Indywidualne lub wtykowe cewki zapłonowe (jedno- lub dwuiskrowe) nasadza się bezpośrednio na świecę zapłonową. Dzięki temu energia zapłonu przekazywana jest praktycznie bez strat bezpośrednio na świecę zapłonową. Dalsza zaleta: Występujące zagłębienie dla świecy zapłonowej jest wykorzystane w zależności od kształtu jako przestrzeń do zamontowania cewki zapłonowej. Indywidualne i wtykowe cewki zapłonowe stosuje się w pojazdach z zapłonem elektronicznym.

Listwy cewek zapłonowych BERU do popularnych pojazdów marki VW, Opel, Peugeot, Citroën i Škoda.



5

#### 5 Listwy cewek zapłonowych

Na jednej listwie cewek zapłonowych umieszczonych jest razem kilka pojedynczych cewek zapłonowych. One są bezpośrednio nasadzane na świecę zapłonową. W celu wczesnego rozpoznania przerw w zapłonie, spalania detonacyjnego i braku iskry dostępne są cewki wyposażone w zintegrowany układ pomiaru prądu jonizacji, który kontroluje optymalne spalanie mieszanki. Listwy cewek zapłonowych BERU są stosowane na przykład w pojazdach marki VW, Opel, Peugeot, Citroën i Škoda.

## Πηνία ανάφλεξης: Πλήρης σειρά προϊόντων, πλήρες δυναμικό πωλήσεων

Η BERU διαθέτει στην αγορά 400 τύπους πηνίων ανάφλεξης, κατάλληλους για περισσότερα από 6.800 διαφορετικά μοντέλα αυτοκινήτων. Μία προσφορά που παρέχει ασφάλεια στον κλάδο συντήρησης και επισκευών.

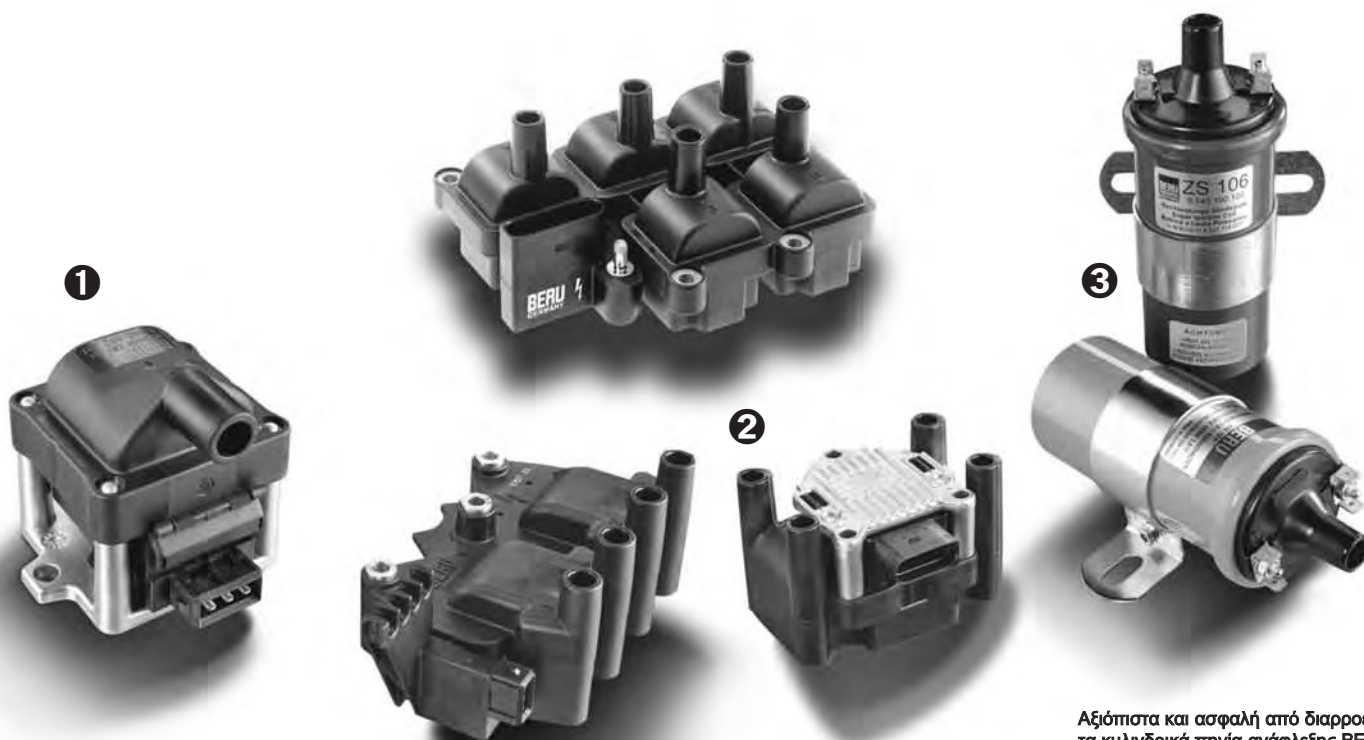

Πηνίο ανάφλεξης με διανομέα BERU με ενσωματωμένη τελική βαθμίδα για περιστροφική διανομή υψηλής τάσης σε μοντέλα της VW και της Audi.

Πολλαπλασιαστές τύπου μπλοκ BERU για τα συνήθη μοντέλα BMW, Fiat, Renault και VW.

Αξιόπιστα και ασφαλή από διαρροές: τα κυλινδρικά πηνία ανάφλεξης BERU για παλαιά κλασικά μοντέλα.

Για τη μείωση των εκπομπών και της κατανάλωσης καυσίμων και τη βελτίωση των επιδόσεων οι τεχνολογίες κινητήρων δεν παύουν ποτέ να εξελίσσονται προς το καλύτερο, μια εξέλιξη που συμπαράσχει και τα συστήματα ανάφλεξης. Η BERU είναι ο ειδικός στην ανάφλεξη. Στην γκάμα προϊόντων αυτό σημαίνει: Η BERU δεν διαθέτει μόνο μπουζί, αλλά την πλήρη αλυσίδα ανάφλεξης, από πηνία ανάφλεξης και καλώδια ανάφλεξης, συνδετήρες και καπάκια διανομέα μέχρι συγκροτήματα ανάφλεξης. Η πλήρης γκάμα προϊόντων. Στο πνεύμα αυτό εξελίσσεται και εμπλουτίζεται συνεχώς και η σειρά πηνίων ανάφλεξης BERU: Η BERU είναι παρούσα σε όλες σχεδόν τις μαζικές παραγωγές των Ευρωπαϊκών κατασκευαστών οχημάτων και προσφέρει στην αγορά συντήρησης και επισκευών τους εκάστοτε κατάλληλους τύπους εξαρτημάτων σε ασυναγώνιστη ποιότητα αρχικού εξοπλισμού. Αυτό σημαίνει ότι στην Ευρώπη, πάνω από 130 εκατομμύρια καταχωρημένα οχήματα βενζίνης, μπορούν να τοποθετήσουν τους πολλαπλασιαστές και τα πηνία ανάφλεξης της BERU. Ας ρίξουμε μια γρήγορη ματιά στα διάφορα είδη πηνίων ανάφλεξης που περιλαμβάνει η γκάμα της BERU.

### 1 Πηνίο ανάφλεξης με διανομέα

Στα πηνία ανάφλεξης με διανομέα, η παραγόμενη υψηλή τάση διοχετεύεται από το πηνίο στο διανομέα ανάφλεξης. Ο διανομέας ανάφλεξης διανέμει αυτή την υψηλή τάση στα αντίστοιχα μπουζί.

### 2 Πολλαπλασιαστές τύπου μπλοκ

Σε έναν πολλαπλασιαστή τύπου μπλοκ υπάρχουν περισσότερα πηνία ανάφλεξης, τα οποία ελέγχουν περισσότερα μπουζί μέσω καλωδίων ανάφλεξης. Οι πολλαπλασιαστές τύπου μπλοκ διατίθενται με και χωρίς ενσωματωμένη τελική βαθμίδα και με τεχνολογία μονού ή διπλού σπινθήρα.

### 3 Κυλινδρικά πηνία ανάφλεξης

Τα κυλινδρικά πηνία ανάφλεξης χρησιμοποιούνται κυρίως σε παλιότερα μοντέλα αυτοκινήτων. Και για αυτές τις κατηγορίες ωστόσο συνιστάται η εγκατάσταση αυθεντικών



Διάφορες εκδόσεις πηνίων ανάφλεξης για υποδοχή μπουζί και πηνίων ανάφλεξης με συνδετήρα για μοντέλα BMW, Fiat, Mercedes-Benz, Porsche, Renault ή VW.

πηνίων ανάφλεξης BERU: Διότι με τη στεγνή και προστατευμένη από διαρροές μόνωση που εξασφαλίζουν μεταξύ του σπειρώματος πηνίου και του κυλινδρικού περιβλήματος παρέχουν σαφώς μεγαλύτερη ασφάλεια. Τα κυλινδρικά πηνία ανάφλεξης, που κατασκευάζονται από φθηνούς προμηθευτές, έχουν πληρωθεί συχνά με λάδι, το οποίο σε περίπτωση προβλήματος ή ατυχήματος υπάρχει κίνδυνος να διαρρεύσει προκαλώντας ανάφλεξη του οχήματος.

#### 4 Πηνία ανάφλεξης για υποδοχή μπουζί και πηνία ανάφλεξης με συνδετήρα

Τα πηνία ανάφλεξης για υποδοχή μπουζί ή πηνία ανάφλεξης με συνδετήρα (με τεχνολογία μονού και διπλού σπινθήρα) τοποθετούνται απευθείας πάνω στο μπουζί, γεγονός που διασφαλίζει τη μετάδοση της ενέργειας ανάφλεξης απευθείας στο μπουζί, ουσιαστικά χωρίς απώλειες απόδοσης. Κι ένα ακόμα πλεονέκτημα: Η ήδη υπάρχουσα υποδοχή μπουζί μπορεί να χρησιμοποιηθεί, ανάλογα με την κατασκευή, ως χώρος τοποθέτησης για το πηνίο ανάφλεξης. Τα πηνία ανάφλεξης για υποδοχή μπουζί και πηνία ανάφλεξης με συνδετήρα χρησιμοποιούνται σε οχήματα με πλήρως ηλεκτρονική ανάφλεξη.

Ράγες πηνίων ανάφλεξης BERU για τα συνήθη μοντέλα VW, Opel, Peugeot, Citroën και Škoda.



#### 5 Ράγες πηνίων ανάφλεξης

Μία ράγα πηνίων ανάφλεξης αποτελείται από περισσότερα επιμέρους πηνία. Τα πηνία αυτά εισάγονται απευθείας στο μπουζί. Για την έγκαιρη διάγνωση διαλείψεων ή αποτυχίας ανάφλεξης και χτυπημάτων κινητήρα κατά την καύση υπάρχει δυνατότητα επιπρόσθετου εξοπλισμού των πηνίων με ενσωματωμένη διάταξη μέτρησης ιοντικού ρεύματος. Οι ράγες πηνίων ανάφλεξης BERU τοποθετούνται για παράδειγμα από τους κατασκευαστές VW, Opel, Peugeot, Citroën και Škoda.

# Gyújtótekercecsek: A teljes program, tele forgalmi lehetőségekkel

A BERU több mint 400 gyújtótekercestípust szállít – több mint 6.800 különböző gépjárműmodellhez. Ez nagy biztonságot nyújt a karbantartó és javító üzletágban.

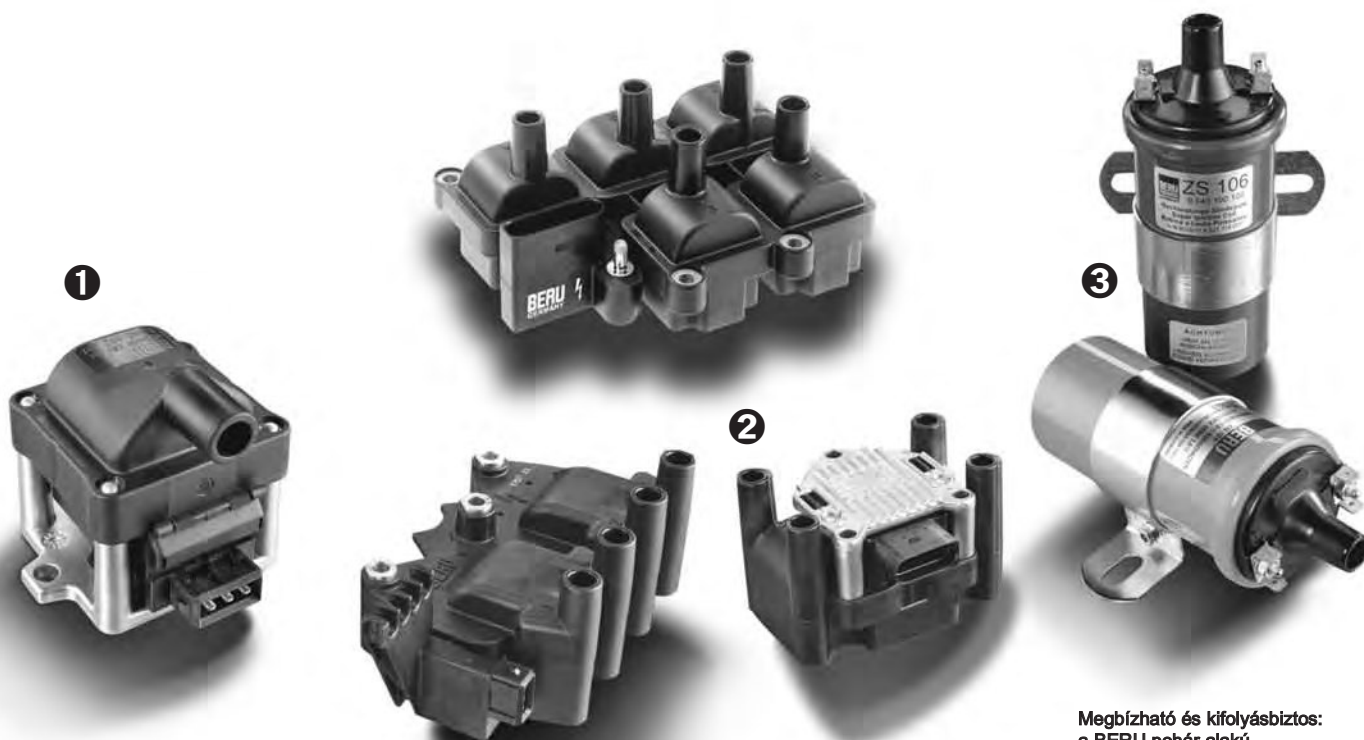

BERU elosztó gyújtótekerecs – beépített végfokozattal a VW / Audi gépjárműmodelljeinél alkalmazott forgó nagyfeszültség-elosztáshoz

BERU tömb gyújtótekercecsek a BMW, Fiat, Renault és a VW közkedvelt gépjárműmodelljeihez.

Megbízható és kifolyásbiztos: a BERU pohár alakú gyújtótekercecsei oldímerekhez.

Az üzemanyag-fogyasztás és az emisszió csökkentése és a hatékonyság javítása érdekében a gyárak egyre tovább optimalizálják a motortechnikát - és vele együtt a gyújtásrendszereket. A gyújtás területén a BERU a szakértő. A választék szélességét illetően ez a következőket jelenti: A BERU nem csak a gyújtógyertyákat szállítja, hanem a gyújtótekercecsektől és gyújtáskábelektől kezdve a dugaszokon és elosztósapkákon át a gyújtómodulokig a teljes gyújtási láncot is. Mindent egy kézből. Így folyik a BERU gyújtótekerecs-programjának állandó továbbfejlesztése és kiegészítése: a BERU az európai gépjárműgyártók csaknem minden jelentős mennyiségi alkalmazásához szállít alkatrészeket - és kompromisszummentes eredeti minőségű megfelelő típusokat kínál a karbantartó és javító piac számára. Ez azt jelenti, hogy Európában 130 milliónál is több benzinmotoros jármű szerelhető fel BERU gyújtótekerccsel. Itt egy rövid áttekintést találhat azokról a gyújtótekerccsfajtákról, amelyek szerepelnek a BERU programjában.

## 1 Elosztó gyújtótekerecs

A gyújtáselosztóval rendelkező gyújtótekercecseknél a létrehozott nagyfeszültség a gyújtótekercestől a gyújtáselosztóhoz jut. A gyújtáselosztó elosztja ezt a nagyfeszültséget a megfelelő gyújtógyertyákhoz.

## 2 Tömb gyújtótekercecsek

Egy tömb gyújtótekerccsben több gyújtótekerecs van összefogva, ezek gyújtásvezetékeken keresztül több gyújtógyertyát vezérelnek. A tömb gyújtótekercecsek beépített végfokozattal vagy anélkül és egyszeres vagy kétszeres szikrával is léteznek.

## 3 Pohár alakú gyújtótekercecsek

A pohár alakú gyújtótekercecsek leginkább a régebbi gépjárműmodellekben kerülnek alkalmazásra. Itt is ajánlatos beépíteni az eredeti BERU márkájú gyújtótekercecseket:



4

Különböző kivitelű gyertyaakna / dugaszos gyújtótekerccsek a BMW, Fiat, Mercedes-Benz, Porsche, Renault vagy a VW gépjárműmodelljeihez.

Ezek ugyanis a tekerccs menetei és a pohár alakú ház közötti száraz és így kifolyásbiztos szigetelésnek köszönhetően lényegesen nagyobb biztonságot nyújtanak. Az olcsó termékeket kínáló által gyártott pohár alakú gyújtótekerccsek gyakran olajjal vannak megtöltve - az pedig hiba esetén vagy balesetkor kifolyhat és tüzet okozhat a gépjárműben.

#### 4 Gyertyaakna / dugaszos gyújtótekerccsek

A gyertyaakna vagy dugaszos gyújtótekerccsek (egyszeres vagy kétszeres szikrával) közvetlenül a gyújtógyertyára kell rádugni. Így a gyújtásenergia gyakorlatilag teljesítményvesztés nélkül jut el közvetlenül a gyújtógyertyához. További előny: A már meglévő gyertyaakna, az alaktól függően, szerelési térként használható a gyújtótekerccs számára. A gyertyaakna és dugaszos gyújtótekerccsek a teljesen elektronikus gyújtással rendelkező gépjárművekben kerülnek alkalmazásra.

BERU gyújtótekerccs sínek a VW, Opel, Peugeot, Citroën és a Škoda közkezdvelt gépjárműveihez.



5

#### 5 Gyújtótekerccs sínek

Egy gyújtótekerccs sínben több egyedi gyújtótekerccs van összefogva. Ezeket közvetlenül a gyújtógyertyákra kell rádugni. A hibás gyújtás, a kopogó égés és a gyújtáskihagyás idejében történő felismeréséhez ezen kívül a tekerccsek beépített ionizációsáram-mérővel is rendelkezhetnek, ami felügyeli a keverék optimális elégését. BERU gyújtótekerccs síneket pl. a VW, Opel, Peugeot, Citroën és a Škoda épít be.

# Bobinas de ignição: Programa completo para um potencial de negócio completo

A BERU fornece mais de 400 velas de ignição para mais de 6800 modelos de veículos diferentes, conferindo assim segurança nos negócios de manutenção e reparação.

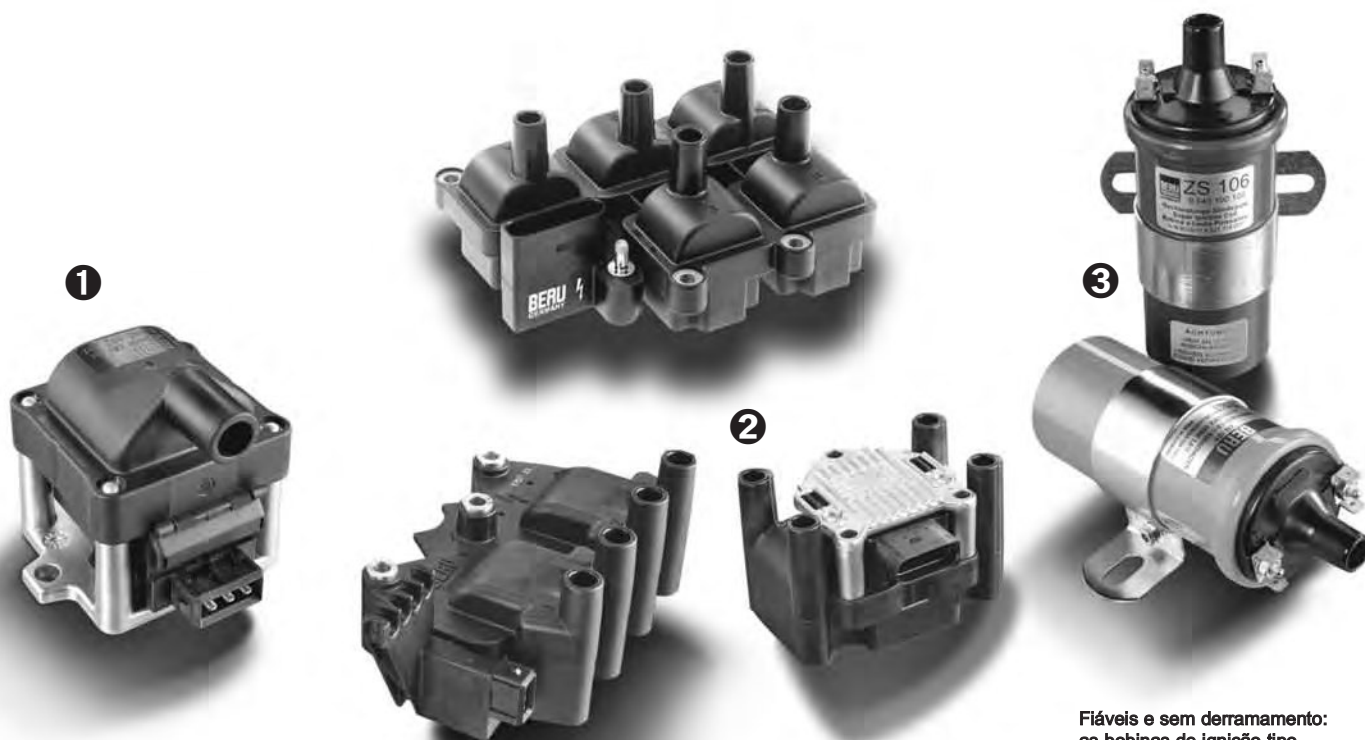

Bobina de ignição distribuidora da BERU com estágio final integrado para distribuição rotativa da alta tensão nos modelos de veículos da VW / Audi

Bobinas de ignição de bloco da BERU para todos os modelos de veículos correntes da BMW, Fiat, Renault e VW.

Fiáveis e sem derramamento: as bobinas de ignição tipo caneca da BERU para Oldtimer.

Para a redução do consumo de combustível e das emissões e para o aumento da eficiência, as tecnologias dos motores estão sempre a ser optimizadas e, conseqüentemente, os sistemas de ignição também. A BERU Systems é a perita em ignição. No que se refere ao sortimento, isso significa que a BERU Systems fornece não só as velas de ignição, como também todo o conjunto da ignição, desde bobinas de ignição e cabos de ignição, a conectores e tampas do distribuidor. Tudo de um mesmo fornecedor. Desta forma, o programa de bobinas de ignição da BERU é constantemente melhorado e complementado: A BERU fornece quase todas as aplicações massificadas relevantes dos fabricantes europeus de veículos e providencia ao mercado de manutenção e reparação os respectivos tipos em qualidade de equipamento original. Isto permite que, só na Europa, mais de 130 milhões de veículos a gasolina matriculados possam ser equipados com as bobines de ignição da BERU. A seguir uma breve visão geral dos diferentes tipos de bobinas de ignição pertencentes ao programa da BERU.

- 1 Bobina de ignição distribuidora**  
 Nas bobinas de ignição com distribuidor de ignição, a alta tensão fornecida passa da bobina de ignição para o distribuidor de ignição. O distribuidor de ignição distribui esta alta tensão pelas respectivas velas de ignição.
- 2 Bobinas de ignição de bloco**  
 Numa bobina de ignição de bloco estão integradas várias bobinas de ignição que comandam várias velas de ignição através de condutores de ignição. As bobinas de ignição de bloco existem na versão com e sem estágio final integrado e com tecnologia de faísca individual ou dupla.
- 3 Bobinas de ignição tipo caneca**  
 As bobinas de ignição tipo caneca são usadas sobretudo em modelos de veículos mais antigos. Também neste caso é recomendável a montagem de bobinas de ignição originais da marca BERU: Estas bobinas são substancial-





Diferentes versões de bobinas de ignição de câmara de vela/de conector para os modelos de veículos da BMW, Fiat, Mercedes-Benz, Porsche, Renault ou VW.



Barras de bobinas de ignição da BERU para os veículos correntes da VW, Opel, Peugeot, Citroën e Škoda.

mente mais seguras graças ao isolamento seco e à prova de derramamento entre o enrolamento da bobina e a caixa da caneca. As bobinas de ignição tipo caneca de fornecedores baratos são muitas vezes atestadas com óleo e, por isso, estão sujeitas ao perigo de derramamento podendo causar o incêndio do veículo após defeitos ou acidentes.

- 4** **Bobinas de ignição de câmara de vela/de conector**  
As bobinas de ignição de câmara de vela ou de conector (com tecnologia de faísca individual ou dupla) são encaixadas directamente na vela de ignição. Desta forma, a energia de ignição pode ser transmitida de forma directa e praticamente sem quaisquer perdas de potência à vela de ignição. Outra vantagem: A câmara da vela de ignição já existente pode, consoante o formato, ser usada como espaço de montagem para a vela de ignição. As bobinas de ignição de câmara de vela ou de conector são usadas em veículos com ignição totalmente electrónica.

- 5** **Barras de bobinas de ignição**  
Numa barra de bobinas de ignição estão integradas várias bobinas de ignição individuais. Estas são encaixadas directamente nas velas de ignição. Para a detecção atempada de falhas de ignição, de combustão detonante e de falhas de combustão, as bobinas podem também estar equipadas com um sistema integrado de medição da corrente iónica que monitoriza a combustão ideal da mistura. Barras de bobinas de ignição BERU são montadas por exemplo pela VW, Opel, Peugeot, Citroën e Škoda.

# Ateşleme bobinleri: Tam program tam ciro potansiyeli

BERU, 6.800'ün üzerinde farklı araç modeli için 400'ün üzerinde ateşleme bobini tipi tedarik eder. Bu, bakım ve onarım işinde güvenlik sağlar.

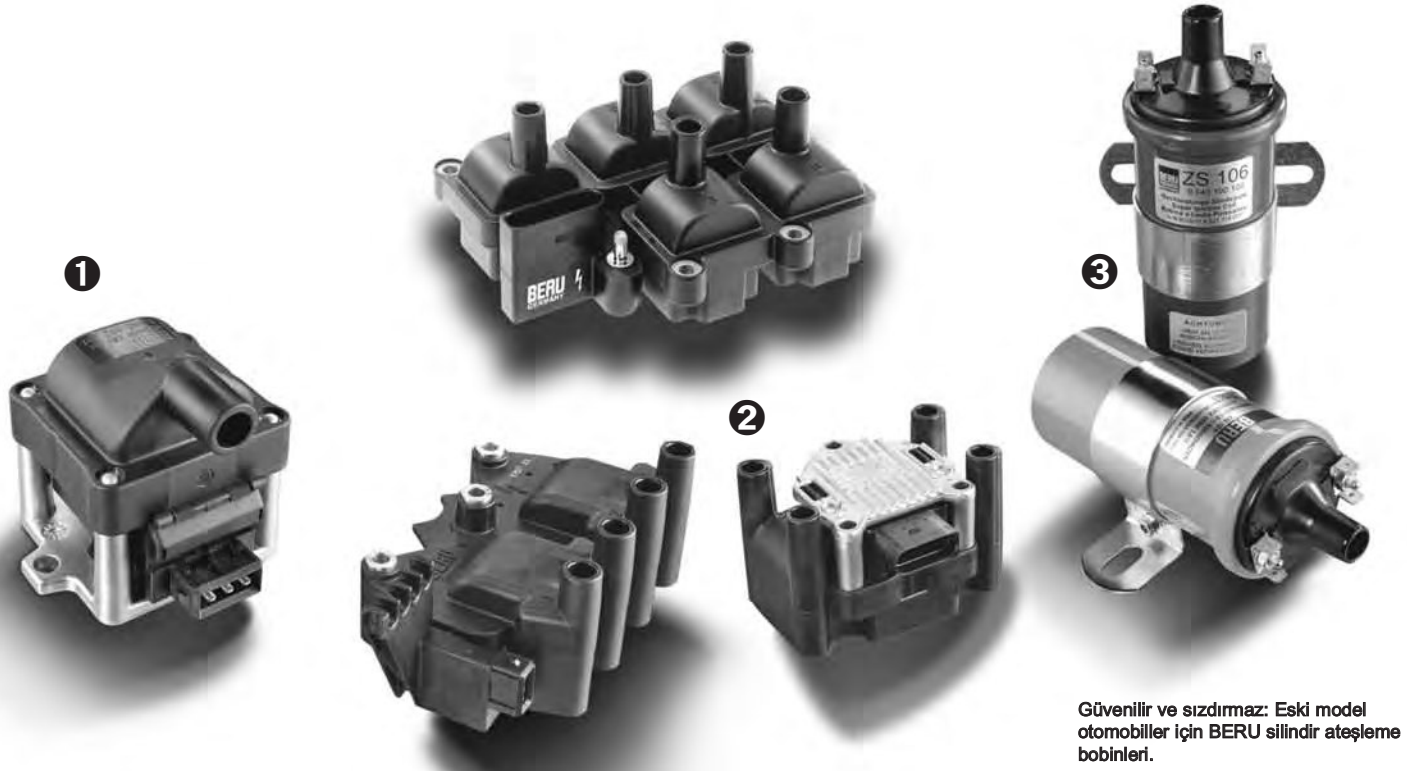

BERU distribütör ateşleme bobini - VW / Audi araç modellerindeki dönen yüksek gerilimli dağıtım için entegre çıkış katlı

Güncel BMW, Fiat, Renault ve VW araç modelleri için BERU blok ateşleme bobinleri.

Güvenilir ve sızdırmaz: Eski model otomobiller için BERU silindir ateşleme bobinleri.

Yakıt tüketimi ve emisyonları azaltmak ve verimlilik artışı sağlamak için motor teknolojileri ve bununla birlikte ateşleme sistemleri sürekli olarak optimize ediliyor. BERU, ateşleme uzmanıdır. Çeşit genişliğinde bunun anlamı: BERU sadece buji tedarik etmez, aynı zamanda ateşleme bobinleri ve ateşleme kablolarından soketler, distribütör kapakları ve ateşleme modüllerine kadar komple bir ateşleme hattı sunar. Her şey tek elden. Bu şekilde BERU ateşleme bobini programı sürekli olarak geliştirilir ve tamamlanır: BERU, Avrupalı araç üreticilerinin neredeyse tüm büyük hacimli kullanımları için ürün tedarik eder ve ilk donanım kalitesinden hiç ödün vermeksizin bakım ve onarım pazarına uygun tipte ürünler sunar. Bu şu anlama gelmektedir, Avrupa'da 130 milyonun üzerinde benzinli aracı BERU ateşleme bobini kullanılabilir. Burada, BERU'nun programında bulunan çeşitli ateşleme bobini türlerine kısa bir genel bakış bulabilirsiniz.

## 1 Distribütör ateşleme bobini

Distribütör ateşleme bobinlerinde, üretilen yüksek gerilim ateşleme bobininden distribütöre gelir. Distribütör, bu yüksek gerilimi ilgili bujilere dağıtır.

## 2 Blok ateşleme bobinleri

Bir blok ateşleme bobini içinde birden çok ateşleme bobini bir araya getirilmiştir ve bu bobinler, ateşleme hatları üzerinden birden çok bujiyi devreye sokar. Blok ateşleme bobinleri, entegre çıkış katlı ve katsız olarak ve tek veya çift kıvılcım tekniğiyle üretilir.

## 3 Silindir ateşleme bobinleri

Silindir ateşleme bobinleri, özellikle daha eski araç modellerinde kullanılır. Burada da orijinal BERU markalı ateşleme bobinlerinin takılması önerilir: Çünkü bu bobinler,



4

BMW, Fiat, Mercedes-Benz, Porsche, Renault veya VW marka araç modelleri için farklı buji yuvalı/ soketli ateşleme bobini modelleri.

Güncel VW, Opel, Peugeot, Citroën ve Škoda marka araçlar için BERU ateşleme bobini çubukları.



5

- 4 bobin sargısı ve silindir muhafazası arasındaki kuru ve sızdırmaz izolasyonları sayesinde belirgin şekilde daha fazla güvenlik sunar. Ucuz ürün tedarikçileri tarafından üretilen silindir ateşleme bobinleri genellikle yağla doldurulmuştur - bu, bir arıza veya kaza durumunda sızdırmaya ve aracın yanmasına neden olabilir.

#### Buji yuvalı/soketli ateşleme bobinleri

Buji yuvalı veya soketli ateşleme bobinleri (tek ve çift kıvılcım tekniğinde) direkt olarak bujiye takılır. Bu sayede, ateşleme enerjisi pratikte hiç güç kaybı olmaksızın doğrudan bujiye aktarılabilir. Diğer bir avantajı: Mevcut buji yuvası, montaj bölümünün tasarımına bağlı olarak ateşleme bobini olarak kullanılabilir. Buji yuvalı ve soketli ateşleme bobinleri, tam elektronik ateşlemeli araçlarda kullanılır.

#### 5 Buji yuvalı/soketli ateşleme bobinleri

Buji yuvalı veya soketli ateşleme bobinleri (tek ve çift kıvılcım tekniğinde) direkt olarak bujiye takılır. Bu sayede, ateşleme enerjisi pratikte hiç güç kaybı olmaksızın doğrudan bujiye aktarılabilir. Diğer bir avantajı: Mevcut buji yuvası, montaj bölümünün tasarımına bağlı olarak ateşleme bobini olarak kullanılabilir. Buji yuvalı ve soketli ateşleme bobinleri, tam elektronik ateşlemeli araçlarda kullanılır.

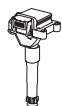

ZS 095	0 040 100 095	Fiat	218
ZS 096	0 040 100 096	Chrysler, Fiat	218
ZS 366	0 040 100 366	Ford	233
ZS 367	0 040 100 367	Ford, Jaguar	233
ZS 368	0 040 100 368	Ford, Jaguar	234
ZS 369	0 040 100 369	Ford	234
ZS 370	0 040 100 370	Ford	234
ZS 371	0 040 100 371	Ford	234
ZS 372	0 040 100 372	Ford	234
ZS 387	0 040 100 387	Ford, Volvo	236
ZS 388	0 040 100 388	Aston Martin	236
ZS 389	0 040 100 389	Aston Martin	236
ZS 392	0 040 100 392	Chrysler	236
ZS 393	0 040 100 393	Chrysler	236
ZS 394	0 040 100 394	Chrysler	236
ZS 395	0 040 100 395	Fispa, Lada, Mitsubishi	236
ZS 396	0 040 100 396	Chrysler	237
ZS 398	0 040 100 398	Chrysler	237
ZS 404	0 040 100 404	Chrysler	237
ZS 405	0 040 100 405	Chrysler	237
ZS 406	0 040 100 406	Chrysler	237
ZS 407	0 040 100 407	Chrysler	237
ZS 408	0 040 100 408	Ford	237
ZS 409	0 040 100 409	Ford	238
ZS 410	0 040 100 410	Ford	238
ZS 416	0 040 100 416	General Motors	238
ZS 417	0 040 100 417	Honda	238
ZS 418	0 040 100 418	Honda	238
ZS 419	0 040 100 419	Honda	238
ZS 421	0 040 100 421	Saturn	238
ZS 422	0 040 100 422	Ford	238
ZS 426	0 040 100 426	Aston Martin	239
ZS 428	0 040 100 428	Alfa Romeo, Fiat	239
ZS 429	0 040 100 429	Volvo	239
ZS 430	0 040 100 430	Toyota	239
ZS 431	0 040 100 431	Chrysler	239
ZS 432	0 040 100 432	Chrysler	239
ZS 433	0 040 100 433	Hyundai, Kia, Mazda	239
ZS 434	0 040 100 434	Hyundai, Kia, Mazda	240

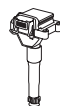

ZS 435	0 040 100 435	Rover	240
ZS 436	0 040 100 436	Hyundai	240
ZS 436	0 040 100 436	Kia, Mazda	240
ZS 437	0 040 100 437	Rover	240
ZS 438	0 040 100 438	Proton	240
ZS 439	0 040 100 439	Ducati	240
ZS 440	0 040 100 440	Fispa	240
ZS 441	0 040 104 009	Ducati	240
ZS 443	0 040 100 443	KTM	241
ZS 444	0 040 100 444	Ducati	241
ZS 449	0 040 100 449	Toyota	241
ZS 450	0 040 100 450	Opel/Vauxhall	241
ZS 451	0 040 100 451	Opel/Vauxhall	241
ZS 508	0 040 100 508	Buick, Chevrolet	242
ZS 513	0 040 100 513	Saipa	242
ZS 515	0 040 100 515	IKCO	242
ZS 516	0 040 100 516	Saipa	242
ZS 518	0 040 100 518	Chery	242
ZS 519	0 040 100 519	Daelim	242
ZS 520	0 040 100 520	Dalim	242
ZS 521	0 040 100 521	Hyundai, Kia, Mitsubishi	243
ZS 522	0 040 100 522	Hyundai	243
ZS 523	0 040 100 523	Daelim	243
ZS 524	0 040 100 524	Daelim	243
ZS 526	0 040 100 526	Hyundai	243
ZS 532	0 040 100 532	Honda	243
ZS 535	0 040 100 535	UAZ (RUSSIA)	243
ZS 536	0 040 100 536	Hyundai	243
ZS 537	0 040 100 537	Ssangyong	244
ZSE 026	0 040 102 026	Opel/Vauxhall	245
ZSE 067	0 040 102 067	Seat, Skoda, Volkswagen	249
ZSE 068	0 040 102 068	Audi, Skoda, Volkswagen	249
ZSE 069	0 040 102 069	Suzuki	249
ZSE 071	0 040 102 071	Nissan	249
ZSE 072	0 040 102 072	Suzuki	249
ZSE 073	0 040 102 073	Nissan	250
ZSE 074	0 040 102 074	Nissan	250
ZSE 075	0 040 102 075	Nissan	250
ZSE 076	0 040 102 076	Nissan	250

**Weitere Anwendungen siehe auch**

For further applications see

 Pour déterminer les autres affectations  
veuillez vous référer à

 Zie voor verdere toepassingen ook  
Para más aplicaciones véase también  
Altre applicazioni vedi

Дальнейшие использования см. также

Pozostale zastosowanie patrz również

Περαιτέρω εφαρμογές βλέπε επίσης στο

Τονάββι alkalmazásokat lásd-nál

Para outras aplicações, ver também

Dider uygulamalar için ayrıca bkz.

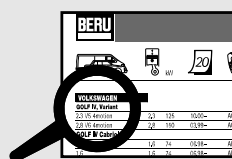
[www.fmecat.eu](http://www.fmecat.eu)

[www.tecdoc.net](http://www.tecdoc.net)

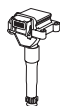

ZSE 077	0 040 102 077	Nissan	250
ZSE 078	0 040 102 078	Nissan	250
ZSE 079	0 040 102 079	Nissan	250
ZSE 080	0 040 102 080	Nissan	250
ZSE 081	0 040 102 081	Nissan	251
ZSE 082	0 040 102 082	Nissan	251
ZSE 083	0 040 102 083	Mazda	251
ZSE 084	0 040 102 084	Mazda	251
ZSE 086	0 040 102 086	Hyundai, Kia	251
ZSE 087	0 040 102 087	Hyundai	251
ZSE 088	0 040 102 088	Nissan, Renault	251
ZSE 126	0 040 102 126	Seat, Skoda, Volkswagen	251
ZSE 127	0 040 102 127	Ferrari	252
ZSE 128	0 040 102 128	Ferrari	252
ZSE 129	0 040 102 129	Lamborghini	252
ZSE 130	0 040 102 130	Aprilia	252
ZSE 131	0 040 102 130	Dacia, Renault	252
ZSE 132	0 040 102 132	Nissan	252
ZSE 133	0 040 102 133	Isuzu	252
ZSE 134	0 040 102 134	Nissan	252
ZSE 135	0 040 102 135	Isuzu	253
ZSE 136	0 040 102 136	Suzuki	253
ZSE 137	0 040 102 137	Audi	253
ZSE 138	0 040 102 138	Audi	253
ZSE 140	0 040 102 140	Mercedes	253
ZSE 142	0 040 102 142	Volkswagen	253
ZSE 143	0 040 102 143	BMW, Citroën, Peugeot	253
ZSE 144	0 040 102 144	BMW	253
ZSE 145	0 040 102 145	BMW	254
ZSE 146	0 040 102 146	Mercedes	254
ZSE 147	0 040 102 147	Opel/Vauxhall	254
ZSE 148	0 040 102 148	Alfa Romeo	254
ZSE 149	0 040 102 149	Opel/Vauxhall	254
ZSE 150	0 040 102 150	Opel/Vauxhall	254
ZSE 151	0 040 102 151	Opel/Vauxhall	254
ZSE 152	0 040 102 152	Opel/Vauxhall	254
ZSE 153	0 040 102 153	Opel/Vauxhall	255

**Weitere Anwendungen siehe auch**

For further applications see  
Pour déterminer les autres affectations  
veuillez vous référer à

Zie voor verdere toepassingen ook  
Para más aplicaciones véase también  
Altre applicazioni vedi

Дальнейшие использования см. также  
Pozostałe zastosowanie patrz również  
Περαιτέρω εφαρμογές βλέπε επίσης στο  
További alkalmazásokat lásd-nál  
Para outras aplicações, ver também  
Dider uygulamalar için ayrıca bkz.

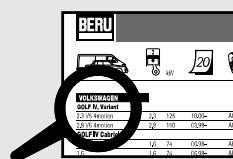

[www.fmecat.eu](http://www.fmecat.eu)



[www.tecdoc.net](http://www.tecdoc.net)

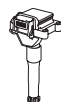

ZM 001	0 040 401 001	204
ZM 002	0 040 401 002	204
ZM 003	0 040 401 003	204
ZM 004	0 040 401 004	204
ZM 005	0 040 401 005	204
ZM 006	0 040 401 006	204
ZM 007	0 040 401 007	204
ZM 008	0 040 401 008	204
ZM 009	0 040 401 009	205
ZM 010	0 040 401 010	205
ZM 012	0 040 401 012	205
ZM 013	0 040 401 013	205
ZM 014	0 040 401 014	205
ZM 015	0 040 401 015	205
ZM 016	0 040 401 016	205
ZM 017	0 040 401 017	205
ZM 018	0 040 401 018	206
ZM 019	0 040 401 019	206
ZM 020	0 040 401 020	206
ZM 022	0 040 401 022	206
ZM 023	0 040 401 023	206
ZM 024	0 040 401 024	206
ZM 025	0 040 401 025	206
ZM 026	0 040 401 026	206
ZM 027	0 040 401 027	207
ZM 028	0 040 401 028	207
ZM 029	0 040 401 029	207
ZM 031	0 040 401 031	207
ZM 032	0 040 401 032	207
ZM 034	0 040 401 034	207
ZM 036	0 040 401 036	207
ZM 038	0 040 401 038	207
ZM 039	0 040 401 039	208
ZM 040	0 040 401 040	208
ZM 041	0 040 401 041	208
ZM 043	0 040 401 043	208
ZM 045	0 040 401 045	208
ZM 046	0 040 401 046	208
ZM 047	0 040 401 047	208
ZM 048	0 040 401 048	208
ZM 049	0 040 401 049	209
ZM 050	0 040 401 050	209
ZM 051	0 040 401 051	209
ZM 052	0 040 401 052	209
ZM 053	0 040 401 053	209
ZM 054	0 040 401 054	209
ZM 055	0 040 401 055	209
ZM 056	0 040 401 056	209
ZM 057	0 040 401 057	210
ZM 058	0 040 401 058	210
ZM 059	0 040 401 059	210
ZM 060	0 040 401 060	210
ZM 061	0 040 401 061	210
ZM 062	0 040 401 062	210
ZM 063	0 040 401 063	210

ZS 014	0 040 100 014	216
ZS 016	0 040 100 016	216
ZS 017	0 040 100 017	216
ZS 029	0 040 100 029	216
ZS 030	0 040 100 030	216
ZS 031	0 040 100 031	216
ZS 036	0 040 100 036	216
ZS 037	0 040 100 037	216
ZS 041	0 040 100 041	217
ZS 043	0 040 100 043	217
ZS 049	0 040 100 049	217
ZS 052	0 040 100 052	217
ZS 053	0 040 100 053	217
ZS 054	0 040 100 054	217
ZS 056	0 040 100 056	217
ZS 068	0 040 100 068	217
ZS 077	0 040 100 077	218
ZS 078	0 040 100 078	218
ZS 079	0 040 100 079	218
ZS 085	0 040 100 085	218
ZS 088	0 040 100 088	218
ZS 090	0 040 100 090	218
ZS 095	0 040 100 095	218
ZS 096	0 040 100 096	218
ZS 105	0 040 100 105	219
ZS 106	0 040 100 106	219
ZS 109	0 040 100 109	219
ZS 110	0 040 100 110	219
ZS 115	0 040 100 115	219
ZS 117	0 040 100 117	219
ZS 118	0 040 100 118	219
ZS 119	0 040 100 119	219
ZS 120	0 040 100 120	220
ZS 121	0 040 100 121	220
ZS 122	0 040 100 122	220
ZS 123	0 040 100 123	220
ZS 124	0 040 100 124	220
ZS 125	0 040 100 125	220
ZS 126	0 040 100 126	220
ZS 127	0 040 100 127	220
ZS 210	0 040 100 210	221
ZS 215	0 040 100 215	221
ZS 220	0 040 100 220	221
ZS 224	0 040 100 224	221
ZS 230	0 040 100 230	221
ZS 231	0 040 100 231	221
ZS 232	0 040 100 232	221
ZS 234	0 040 100 234	221
ZS 237	0 040 100 237	222
ZS 238	0 040 100 238	222
ZS 239	0 040 100 239	222
ZS 241	0 040 100 241	222
ZS 242	0 040 100 242	222
ZS 243	0 040 100 243	222
ZS 244	0 040 100 244	222
ZS 245	0 040 100 245	222
ZS 246	0 040 100 246	223
ZS 247	0 040 100 247	223
ZS 248	0 040 100 248	223
ZS 249	0 040 100 249	223
ZS 250	0 040 100 250	223
ZS 251	0 040 100 251	223
ZS 252	0 040 100 252	223

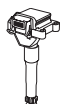

ZS 253	0 040 100 253	223
ZS 254	0 040 100 254	224
ZS 255	0 040 100 255	224
ZS 256	0 040 100 256	224
ZS 257	0 040 100 257	224
ZS 258	0 040 100 258	224
ZS 259	0 040 100 259	224
ZS 261	0 040 100 261	224
ZS 263	0 040 100 263	224
ZS 264	0 040 100 264	225
ZS 266	0 040 100 266	225
ZS 267	0 040 100 267	225
ZS 269	0 040 100 269	225
ZS 274	0 040 100 274	225
ZS 275	0 040 100 275	225
ZS 276	0 040 100 276	225
ZS 277	0 040 100 277	225
ZS 278	0 040 100 278	226
ZS 279	0 040 100 279	226
ZS 280	0 040 100 280	226
ZS 281	0 040 100 281	226
ZS 282	0 040 100 282	226
ZS 283	0 040 100 283	226
ZS 284	0 040 100 284	226
ZS 296	0 040 100 296	226
ZS 297	0 040 100 297	227
ZS 298	0 040 100 298	227
ZS 299	0 040 100 299	227
ZS 300	0 040 100 300	227
ZS 301	0 040 100 301	227
ZS 302	0 040 100 302	227
ZS 304	0 040 100 304	227
ZS 306	0 040 100 306	227
ZS 307	0 040 100 307	228
ZS 308	0 040 100 308	228
ZS 309	0 040 100 309	228
ZS 310	0 040 100 310	228
ZS 311	0 040 100 311	228
ZS313	0 040 103 007	228
ZS 314	0 040 100 314	228
ZS 315	0 040 100 315	228
ZS 316	0 040 100 316	229
ZS 317	0 040 100 317	229
ZS 318	0 040 100 318	229
ZS 319	0 040 100 319	229
ZS 320	0 040 100 320	229
ZS 321	0 040 100 321	229
ZS 322	0 040 100 322	229
ZS 323	0 040 100 323	229
ZS 324	0 040 100 324	230
ZS 325	0 040 100 325	230
ZS 326	0 040 100 326	230
ZS 327	0 040 100 327	230
ZS 337	0 040 100 337	230
ZS 338	0 040 100 338	230
ZS 339	0 040 100 339	230
ZS 340	0 040 100 340	230
ZS 341	0 040 100 341	231
ZS 342	0 040 100 342	231
ZS 343	0 040 100 343	231
ZS 344	0 040 100 344	231
ZS 345	0 040 100 345	231
ZS 346	0 040 100 346	231

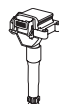

ZS 347	0 040 100 347	231
ZS 348	0 040 100 348	231
ZS 349	0 040 100 349	232
ZS 350	0 040 100 350	232
ZS 351	0 040 100 351	232
ZS 352	0 040 100 352	232
ZS 353	0 040 100 353	232
ZS 354	0 040 100 354	232
ZS 355	0 040 100 355	232
ZS 356	0 040 100 356	232
ZS 357	0 040 100 357	233
ZS 358	0 040 100 358	233
ZS 359	0 040 100 359	233
ZS 360	0 040 100 360	233
ZS 361	0 040 100 361	233
ZS 365	0 040 100 365	233
ZS 366	0 040 100 366	233
ZS 367	0 040 100 367	233
ZS 368	0 040 100 368	234
ZS 369	0 040 100 369	234
ZS 370	0 040 100 370	234
ZS 371	0 040 100 371	234
ZS 372	0 040 100 372	234
ZS 375	0 040 104 100	234
ZS 376	0 040 100 376	234
ZS 377	0 040 104 006	234
ZS 378	0 040 104 002	235
ZS 379	0 040 100 379	235
ZS 380	0 040 100 380	235
ZS 381	0 040 100 381	235
ZS 382	0 040 100 382	235
ZS 383	0 040 100 383	235
ZS 384	0 040 100 384	235
ZS 385	0 040 100 385	235
ZS 386	0 040 100 386	236
ZS 387	0 040 100 387	236
ZS 388	0 040 100 388	236
ZS 389	0 040 100 389	236
ZS 392	0 040 100 392	236
ZS 393	0 040 100 393	236
ZS 394	0 040 100 394	236
ZS 395	0 040 100 395	236
ZS 396	0 040 100 396	237
ZS 398	0 040 100 398	237
ZS 400	0 040 100 400	237
ZS 404	0 040 100 404	237
ZS 405	0 040 100 405	237
ZS 406	0 040 100 406	237
ZS 407	0 040 100 407	237
ZS 408	0 040 100 408	237
ZS 409	0 040 100 409	238
ZS 410	0 040 100 410	238
ZS 416	0 040 100 416	238
ZS 417	0 040 100 417	238
ZS 418	0 040 100 418	238
ZS 419	0 040 100 419	238
ZS 421	0 040 100 421	238
ZS 422	0 040 100 422	238
ZS 426	0 040 100 426	239
ZS 427	0 040 100 427	239
ZS 428	0 040 100 428	239
ZS 429	0 040 100 429	239
ZS 430	0 040 100 430	239

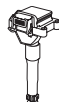

ZS 431	0 040 100 431	239
ZS 432	0 040 100 432	239
ZS 433	0 040 100 433	239
ZS 434	0 040 100 434	240
ZS 435	0 040 100 435	240
ZS 436	0 040 100 436	240
ZS 437	0 040 100 437	240
ZS 438	0 040 100 438	240
ZS 439	0 040 100 439	240
ZS 440	0 040 100 440	240
ZS 441	0 040 104 009	240
ZS 443	0 040 100 443	241
ZS 444	0 040 100 444	241
ZS 449	0 040 100 449	241
ZS 450	0 040 100 450	241
ZS 451	0 040 100 451	241
ZS 501	0 040 100 501	241
ZS 502	0 040 100 502	241
ZS 507	0 040 100 507	241
ZS 508	0 040 100 508	242
ZS 511	0 040 100 511	242
ZS 513	0 040 100 513	242
ZS 515	0 040 100 515	242
ZS 516	0 040 100 516	242
ZS 518	0 040 100 518	242
ZS 519	0 040 100 519	242
ZS 520	0 040 100 520	242
ZS 521	0 040 100 521	243
ZS 522	0 040 100 522	243
ZS 523	0 040 100 523	243
ZS 524	0 040 100 524	243
ZS 526	0 040 100 526	243
ZS 532	0 040 100 532	243
ZS 535	0 040 100 535	243
ZS 536	0 040 100 536	243
ZS 537	0 040 100 537	244
ZSE 001	0 040 402 001	244
ZSE 002	0 040 402 002	244
ZSE 003	0 040 402 003	244
ZSE 004	0 040 402 004	244
ZSE 006	0 040 402 006	244
ZSE 007	0 040 402 007	244
ZSE 008	0 040 402 008	244
ZSE 009	0 040 402 009	245
ZSE 010	0 040 402 010	245
ZSE 011	0 040 402 011	245
ZSE 012	0 040 102 012	245
ZSE 013	0 040 102 013	245
ZSE 019	0 040 102 019	245
ZSE 021	0 040 102 021	245
ZSE 026	0 040 102 026	245
ZSE 029	0 040 102 029	246
ZSE 030	0 040 102 030	246
ZSE 031	0 040 102 031	246
ZSE 032	0 040 102 032	246
ZSE 033	0 040 102 033	246
ZSE 037	0 040 102 037	246
ZSE 039	0 040 102 039	246
ZSE 040	0 040 102 040	246
ZSE 041	0 040 102 041	247
ZSE 042	0 040 102 042	247
ZSE 043	0 040 102 043	247
ZSE 044	0 040 102 044	247

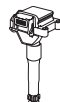

ZSE 045	0 040 102 045	247
ZSE 046	0 040 102 046	247
ZSE 047	0 040 102 047	247
ZSE 048	0 040 102 048	247
ZSE 051	0 040 102 051	248
ZSE 052	0 040 102 052	248
ZSE 054	0 040 102 054	248
ZSE 055	0 040 102 055	248
ZSE 056	0 040 102 056	248
ZSE 059	0 040 102 059	248
ZSE 061	0 040 102 061	248
ZSE 062	0 040 102 062	248
ZSE 063	0 040 102 063	249
ZSE 065	0 040 102 065	249
ZSE 066	0 040 102 066	249
ZSE 067	0 040 102 067	249
ZSE 068	0 040 102 068	249
ZSE 069	0 040 102 069	249
ZSE 071	0 040 102 071	249
ZSE 072	0 040 102 072	249
ZSE 073	0 040 102 073	250
ZSE 074	0 040 102 074	250
ZSE 075	0 040 102 075	250
ZSE 076	0 040 102 076	250
ZSE 077	0 040 102 077	250
ZSE 078	0 040 102 078	250
ZSE 079	0 040 102 079	250
ZSE 080	0 040 102 080	250
ZSE 081	0 040 102 081	251
ZSE 082	0 040 102 082	251
ZSE 083	0 040 102 083	251
ZSE 084	0 040 102 084	251
ZSE 086	0 040 102 086	251
ZSE 087	0 040 102 087	251
ZSE 088	0 040 102 088	251
ZSE 126	0 040 102 126	251
ZSE 127	0 040 102 127	252
ZSE 128	0 040 102 128	252
ZSE 129	0 040 102 129	252
ZSE 130	0 040 102 130	252
ZSE 131	0 040 102 130	252
ZSE 132	0 040 102 132	252
ZSE 133	0 040 102 133	252
ZSE 134	0 040 102 134	252
ZSE 135	0 040 102 135	253
ZSE 136	0 040 102 136	253
ZSE 137	0 040 102 137	253
ZSE 138	0 040 102 138	253
ZSE 140	0 040 102 140	253
ZSE 142	0 040 102 142	253
ZSE 143	0 040 102 143	253
ZSE 144	0 040 102 144	253
ZSE 145	0 040 102 145	254
ZSE 146	0 040 102 146	254
ZSE 147	0 040 102 147	254
ZSE 148	0 040 102 148	254
ZSE 149	0 040 102 149	254
ZSE 150	0 040 102 150	254
ZSE 151	0 040 102 151	254
ZSE 152	0 040 102 152	254
ZSE 153	0 040 102 153	255
ZSE 502	0 040 102 502	255



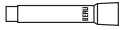

ZLE 232	0 300 122 115	256
ZLE 233	0 300 122 116	256
ZLE 234	0 300 122 111	256
ZLE 255	0 300 122 114	256
ZLE 276	0 300 122 117	256
ZLE 277	0 300 122 118	256
ZLE 278	0 300 122 119	256
ZLE 288	0 300 122 122	256



GS 17	0 010 020 022	257
GS 21	0 010 020 021	257
GS 28	0 010 020 028	257
GS 29	0 010 020 029	257
GS 39	0 010 020 039	257
GS 51	0 010 020 051	257



ZE 115	0 300 811 720	258
ZE 116	0 300 811 653	258



WZ 04-2	0 110 510 007	259
WZ 06-2	0 110 510 033	259
WZ 09-2	0 110 510 008	259
WZ 18-2	0 110 520 001	259
WZR 09 KF	0 110 510 010	259



ZA 500	0 040 200 500	260
ZA 501	0 040 200 501	260
ZA 503	0 040 200 503	260
ZA 509	0 040 200 509	260
ZA 510	0 040 200 510	260



ZSA 042	0 890 300 042	261
ZSA 043	0 890 300 043	261
ZSA 044	0 890 300 044	261

## VERWENDUNG

Fahrzeuge vor Baujahr 1984 sind in den folgenden Verwendungen nur noch teilweise berücksichtigt. Alle Fahrzeuge finden Sie im online Produktfinder unter [www.fmecat.eu](http://www.fmecat.eu) oder auf der TecDoc-CD, die Sie unter [www.tecdoc.net](http://www.tecdoc.net) bestellen können.

Fahrzeuge/Motoren identischer Baujahre können mit unterschiedlichen Zündsystemen ausgerüstet sein (z. B. Bosch, Delco, Ducellier, ...). Achten Sie deshalb bei der Zündspulen-Auswahl auf den Hersteller des eingebauten Zündsystems.

## APPLICATION

Only some of the vehicles manufactured prior to 1984 are taken into consideration in the following applications. All the vehicles are available online in the Product Finder at [www.fmecat.eu](http://www.fmecat.eu) or on the TecDoc CD, which you can order at [www.tecdoc.net](http://www.tecdoc.net).

Vehicles/engines with identical years of manufacture may be equipped with different ignition systems (e.g. Bosch, Delco, Ducellier, ...). For this reason, always check the manufacturer of the ignition system installed when selecting ignition components.

## UTILISATION

Les utilisations décrites ci-après ne s'appliquent qu'en partie aux véhicules construits avant l'année 1984. Vous trouverez tous les véhicules dans le moteur de recherche de produits en ligne sur [www.fmecat.eu](http://www.fmecat.eu) ou sur le CD TecDoc que vous pouvez commander sur [www.tecdoc.net](http://www.tecdoc.net).

Les véhicules/moteurs construits au cours de la même année peuvent être équipés de systèmes d'allumage différents (par ex. Bosch, Delco, Ducellier, ...). Veuillez donc faire attention au fabricant du système d'allumage installé, lors du choix des pièces d'allumage.

## TOEPASSING

Voor voertuigen van voor bouwjaar 1984 gelden de volgende toepassingen slechts gedeeltelijk. U vindt alle voertuigen in de online productfinder onder [www.fmecat.eu](http://www.fmecat.eu) of op de TecDoc-CD, die u kunt bestellen op [www.tecdoc.net](http://www.tecdoc.net).

Voertuigen/motoren van identieke bouwjaren kunnen met verschillende ontstekingssystemen zijn uitgerust (bijv. Bosch, Delco, Ducellier, ...). Let daarom bij de selectie van bobines op de fabrikant van het ingebouwde ontstekingssysteem

## APLICACION

Los vehículos anteriores al año de construcción 1984 solo se tienen en cuenta parcialmente en los usos que se indican a continuación. Encontrará todos los vehículos en el buscador de productos online, en [www.fmecat.eu](http://www.fmecat.eu) o en el CD TecDoc que puede pedir bajo en [www.tecdoc.net](http://www.tecdoc.net).

Los vehículos/motores de años de construcción idénticos pueden estar equipados con diferentes sistemas de encendido (p.ej. Bosch, Delco, Ducellier, ...). Por lo tanto, preste atención en el momento de elección de los componentes de encendido, al fabricante del sistema de encendido instalado.

## L'USO

Soltanto autoveicoli costruiti prima dell'anno 1984 vengono ancora in parte considerati per le seguenti applicazioni. Tutte le autovetture si trovano nel finder prodotti al sito [www.fmecat.eu](http://www.fmecat.eu) oppure sul CD TecDoc, che può essere ordinato al sito [www.tecdoc.net](http://www.tecdoc.net).

Gli autoveicoli/motori degli stessi anni di costruzione possono essere equipaggiati con diversi sistemi d'accensione (per esempio Bosch, Delco, Ducellier, ...). Pertanto, per la scelta dei componenti d'accensione si raccomanda di osservare il costruttore del sistema d'accensione integrato.

## ПРИМЕНЕНИЕ

Автомобили до 1984 года выпуска в указанных ниже применениях учтены лишь частично. Все транспортные средства можно найти в онлайн-перечне продукции на сайте фирмы BERU ([www.beru.com/produktfinder](http://www.beru.com/produktfinder)), в электронном каталоге BERU на компакт-диске (№ заказа 5 000 004 018) или на компакт-диске с технической документацией, который можно заказать на сайте [www.tecdoc.de](http://www.tecdoc.de).

Автомобили/двигатели одного года выпуска могут быть оборудованы различными системами зажигания (например, Bosch, Delco, Ducellier, ...). Поэтому при выборе катушек зажигания примите во внимание изготовителя системы зажигания

## ALKALMAZÁS

A következő felhasználói szövegekben az 1984 előtt előállított járműveket csak részben vettük figyelembe. Minden járművet megtalálhat az online termékkeresőben a [www.fmecat.eu](http://www.fmecat.eu) vagy a TecDoc CD-n, amit a [www.tecdoc.net](http://www.tecdoc.net) címen rendelhet meg.

Előfordulhat, hogy az azonos gyártási évű gépjárművek/motorok eltérő gyújtásrendszerrel vannak felszerelve (pl. Bosch, Delco, Ducellier, ...). Ezért a gyújtótekercs kiválasztásánál ügyeljen a beépített gyújtásrendszer gyártójára.

## ZASTOSOWANIE

Pojazdy z przed roku 1984 są na poniższej liście uwzględnione jedynie częściowo. Wszystkie pojazdy znajdziesz online w wyszukiwarce produktów pod adresem [www.fmecat.eu](http://www.fmecat.eu) lub na CD TecDoc, którą możesz zamówić pod adresem [www.tecdoc.net](http://www.tecdoc.net).

Pojazdy/silniki o tym samym roku produkcji mogą być wyposażone w różne układy zapłonowe (np. Bosch, Delco, Ducellier, ...). Dlatego przy doborze cewki zapłonowej należy sprawdzić producenta zastosowanego układu zapłonowego

## APLICAÇÃO

Apenas alguns veículos fabricados antes de 1984 são tomados em consideração nas seguintes aplicações. Todos os veículos estão disponíveis na internet no Product Finder em [www.fmecat.eu](http://www.fmecat.eu) ou no catálogo electrónico TecDoc, o qual poderá encomendar em [www.tecdoc.net](http://www.tecdoc.net).

Os veículos/motores do mesmo ano de construção podem estar equipados com sistemas de ignição diferentes (p. ex. Bosch, Delco, Ducellier, ...). Por isso, ao seleccionar as peças de substituição para o seu sistema de ignição, tenha atenção ao fabricante do sistema.

## ΧΡΗΣΗ

Μόνο μερικά από τα οχήματα που κατασκευάστηκαν πριν από το 1984 λαμβάνονται υπόψη στις ακόλουθες εφαρμογές. Όλα τα οχήματα υπάρχουν στην online αναζήτηση προϊόντων στο [www.fmecat.eu](http://www.fmecat.eu) ή στον ηλεκτρονικό κατάλογο TecDoc, τον οποίο μπορείτε να παραγγείλετε στο [www.tecdoc.net](http://www.tecdoc.net).

Οχήματα/κινητήρες ίδιου έτους κατασκευής μπορεί να διαθέτουν διαφορετικά συστήματα ανάφλεξης (π.χ. Bosch, Delco, Ducellier, ...). Συνεπώς, κατά την επιλογή πηνίων ανάφλεξης προσέξτε τον κατασκευαστή του εγκατεστημένου συστήματος ανάφλεξης

## KULLANIM

1984'ten önce üretilen araçlardan sadece bazıları bu uygulamada dikkate alınmıştır. Tüm araçları [www.fmecat.eu](http://www.fmecat.eu) online Ürün Bulucu bölümünden ya da [www.tecdoc.net](http://www.tecdoc.net) adresinden sipariş verebileceğiniz elektronik TecDoc katalogundan bulabilirsiniz.

Aynı yılda üretilen araçlar/motorlar, farklı ateşleme sistemleriyle donatılmış olabilir (örn. Bosch, Delco, Ducellier, ...). Bu nedenle, ateşleme bobini seçerken, takılmış olan ateşleme sisteminin üreticisine dikkat ediniz

	<p><b>Hubraum</b> Capacity Cylindrée Motorinhoud Cilindrada Cilindrata Рабочий объем rojemnosc skokowa Κυβισμός Lökettérfogat Cilindrada Silindir hacmi</p>		<p><b>Zündungskassette</b> Ignition cassette Cassette d'allumage Ontstekingscassette Caja de encendido Casseta di accensione Кассета зажигания Kaseta zapłonowa Κασέτα ανάφλεξης Gyújtáskazetta Cassete de ignição Ateşleme kaseti</p>
	<p><b>Baujahr</b> Year Année de fabrication Bouwjaar Año de modelo Anno di costr. Год изготовления rok produkcji Ετος κατασκευής Gyártási év Ano de construção Üretim yılı</p>		<p><b>Zündspulenblock</b> Ignition coil block Bloc d'allumage Bobineblok Bloque de bobinas de encendido Blocco bobine di accensione Блок катушек зажигания Blok cewek zapłonowych Μπλοκ πηνίων ανάφλεξης Gyújtótekercsblokk Bloco de bobina de ignição Ateşleme bobini bloğu</p>
	<p><b>Motorbezeichnung</b> Engine type Désignation du moteur Motoraand Designación del motor Denom. Motore Обозн. двигателя ozn. silnika Όνομ. κινητήρα Motormegi. Designação do motor Motor tanımı</p>		<p><b>Zündspule für Verteiler-Zündanlage</b> Ignition coils for distributor ignition systems Bobines d'allumage pour systèmes d'allumage à distributeur Bobine voor verdelerontsteking Bobinas de encendido para instalaciones de encendido de distribuidor Bobine di accensione per impianti di accensione a spinterogeno Катушка зажигания для системы зажигания с распределителем Cewka zapłonowa do rozdzielacza zapłonu Πηνίο ανάφλεξης για σύστημα ανάφλεξης διανομέα Gyújtótekercs elosztó gyújtóberendezéshez Bobina de ignição para sistemas de ignição com distribuidor Distribütör ateşleme sistemi için ateşleme bobini</p>
	<p><b>Zylinder</b> Cylinder Cylindre Cilinder Cilindro Cilindro цилиндр Cylinder κύλινδρος Henger Cilindro Silindir</p>		<p><b>Stecker für Zündspulen</b> Connectors for ignition coils Embout pour les bobines d'allumage Stekker voor bobines Conector para bobinas de encendido Spinotto per bobine di accensione Штекеры для катушек зажигания Wtyczka do cewek zapłonowych Συνδετήρας για πηνία ανάφλεξης Dugasz gyújtótekersekhez Conector para bobinas de ignição Ateşleme bobini soketi</p>
	<p><b>Zündleitungen</b> Ignition leads Câbles d'allumage Ontstekingskabels Cables de encendido Cavi di accensione Кабели высокого напряжения Przewody zapłonowe Καλώδια ανάφλεξης Gyújtóvezetékek Cabo de ignição Ateşleme hatları</p>		<p><b>Zündmodule</b> Ignition modules Module d'allumage Ontstekingsmodules Módulos de encendido Moduli di accensione Μοδูลι зажигания Moduly zapłonowe Στοιχεία ανάφλεξης Gyújtóegységek Módulo de ignição Ateşleme modülleri</p>
	<p><b>Stecker-/Stabzündspule</b> plug top / rod ignition coil bobine d'allumage à 1 sortie / à crayon Stekker-/staafbougie Bobina de encendido para supresor/cilíndricas bobina d'accensione a spina/ad asta Штекерная/стержневая катушка зажигания Cewka zapłonowa wtykowa/prętowa Πηνίο ανάφλεξης με συνδετήρα / Πηνίο ανάφλεξης τύπου ράβδου Dugasz-/rúd-gyújtótekercs bobinas de ignição de encaixe/de haste Soketli/çubuk ateşleme bobini</p>		<p><b>Stationärmotoren</b> stationary engines Moteurs stationnaires Stationaire motoren Motores estacionarios motori stazionari Стационарные двигатели Silniki stacjonarne Στάσιμοι κινητήρες stabil motorok Motores em regime permanente Sabit motorlar</p>



**Wasserschutzformteile**

Moulded parts for water protection  
Pièces moulées d'étanchéité à l'eau  
Waterbeschermkappen  
Piezas especiales de protección contra el agua  
Elementi di forma antispruzzo  
Водозащитные форматные детали  
Ksztaltki chroniące przed wodą  
Χυτά μέρη προστασίας νερού  
Víz behatólása ellen védő idomdarabok  
Molde de protecção contra água  
Su koruyucu kalıp parçaları



**Flachsteckzunge und Anschlussstift Ø 4 mm**

Flat plug connector with terminal pin, Ø 4 mm  
Langnette de connexion par clip avec avec une broche de Ø 4 mm  
Platte steektong met aansluitstift 4 mm  
Lengüeta de enchufe plana con clavija de conexión Ø 4 mm  
Linguetta ad innesto piatta con perno di collegamento Ø 4 mm  
Плоский штекерный язычок с присоединительным штифтом 4 мм  
Konektor płaski 4 mm  
Αρσενικός συνδετήρας με επίπεδο ακροδέκτη με ακίδα σύνδεσης 4 mm  
Laposdugó 4 mm-es csatlakozóbemnettel  
Lingueta plana com pino de conexão Ø 4 mm  
Düz bağlantı dili ve bağlantı pimi Ø 4 mm



**Zündanker**

Magnetos  
Induits d'allumage  
Magneetanker  
Inducido de encendido magnético  
Indotti di accensione  
Якорь магнето  
Iskronwniki  
Μαγνητική άγκυρα ανάφλεξης  
Gyújtóforgórészek  
bobina de ignição  
Ateşleme ankrajı



**SAE Kontaktfeder**

SAE Contact spring  
SAE Ressort de contact  
SAE contactveer  
SAE Muelle a contact  
SAE Molla di contact  
Контактная пружина SAE  
Sprężyna stykowa SAE  
Ελατήριο επαφής SAE  
SAE rugós érintkező  
SAE Mola de contact  
SAE kontak yayı

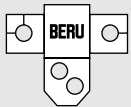

**Vorschaltwiderstände**

Series resistors  
Résistances additionelles  
Voorschakelweerstand  
Resistencias intercaladas  
Resistenze addizionali  
Дополнительные резисторы  
Oporniki wstępne  
Συμπληρωματικές αντιστάσεις  
Előtét-ellenállások  
resistências em série  
Ön dirençler



**Sägezahn**

Saw tooth  
Dent de Scie  
Zaagtand  
Diente de sierra  
Dente di sega  
Пилообразный зуб  
Stopka zębata  
Οδόντωση  
Fűrészfog  
Dente de serra  
Testere dişi



**Flachsteckzunge**

Flat plug connector  
Langnette de connexion par clip  
Platte steektong  
Lengüeta de enchufe plana  
Linguetta ad innesto piatta  
Плоский штекерный язычок  
Konektor płaski  
Αρσενικός συνδετήρας με επίπεδο ακροδέκτη  
Laposdugó  
Lingueta plana  
Düz bağlantı dili



DIN



FORD



SAE



M4



kW

**ACURA****INTEGRA**

1.8	1.9	77	10.90–09.93	F18A2	4	ZS 278	
-----	-----	----	-------------	-------	---	--------	--

**ALFA ROMEO****145**

1.4 i.e.	1.4	66	07.94–12.96	AR 33501	4	ZS 283	
1.4 i.e. 16V T.S.	1.4	76	02.99–01.01	AR 33503	4	ZS 309	ZLE 288
1.6 i.e.	1.6	76	10.94–12.96	AR 33201	4	ZS 234	
1.6 i.e. 16V T.S.	1.6	88	02.99–01.01	AR 67601 Fgst.Nr.3174688→	4	ZS 309	ZLE 288
1.7 i.e. 16V	1.7	95	10.94–12.96	AR 33401	4	ZS 234	
1.8 i.e. 16V	1.7	106	02.99–01.01	AR 32201	4	ZS 309	ZLE 288
2.0 16V Quadrifoglio	2.0	114	03.98–01.01	AR 32301	4	ZS 309	ZLE 288

**146**

1.4 i.e. 16V T.S.	1.4	76	02.99–01.01	AR 33503	4	ZS 309	ZLE 288
1.6 i.e.	1.6	76	12.94–12.96	AR 33201	4	ZS 234	
1.6 i.e. 16V T.S.	1.6	88	02.99–01.01	AR 67601	4	ZS 309	ZLE 288
1.7 i.e. 16V	1.7	95	12.94–12.96	AR 33401	4	ZS 234	
1.8 i.e. 16V T.S.	1.7	106	02.99–01.01	AR 32201	4	ZS 309	ZLE 288
2.0 16V Quadrifoglio	2.0	114	02.99–01.01	AR 32301	4	ZS 309	ZLE 288

**147**

1.6 16V T.SPARK	1.6	88	01.01–03.10	AR 32104	4	ZS 361	ZLE 288
1.6 16V T.SPARK ECO	1.6	77	01.01–03.10	AR 37203	4	ZS 361	ZLE 288
2.0 16V T.SPARK	2.0	110	01.01–03.10	AR 32310	4	ZS 361	ZLE 288
3.2 GTA	3.2	184	02.03–03.10	932 A.000	6	ZS 428	

**155**

1.7 T.S.	1.7	83	04.93–04.96	AR 67103	4	ZS 234	
1.7 T.S.	1.7	85	04.93–04.96	AR 67105	4	ZS 234	
1.8 T.S.	1.8	77	02.92–12.97	AR 67402	4	ZS 234	
1.8 T.S.	1.8	95	02.92–06.93	AR 67101	4	ZS 234	
1.8 T.S. Sport	1.8	93	01.92–12.96	AR 67101/AR 67102	4	ZS 234	
2.0 16V Turbo Q4	2.0	137	01.92–12.97	AR 67203	4	ZS 283	
2.0 16V Turbo Q4	2.0	140	01.92–12.97	AR 67203	4	ZS 283	
2.0 T.S.	2.0	104	02.92–02.95	AR 67202	4	ZS 234	
2.0 T.S.	2.0	106	02.92–04.93	AR 67201	4	ZS 234	
2.5 V6	2.5	120	10.92–12.97	AR 67302/AR 67303	6	ZS 230	
2.5 V6	2.5	121	02.92–09.96	AR 67301	6	ZS 230	

**156**

1.6 16V T.SPARK	1.6	88	09.97–09.00	AR 32102/AR 32103/AR 32104/AR 67601	4	ZS 309	ZLE 288
1.6 16V T.SPARK	1.6	88	09.00–09.05	AR 32102/AR 32103/AR 32104/AR 67601	4	ZS 361	ZLE 288
1.8 16V T.SPARK	1.7	103	10.00–09.05	AR 32205	4	ZS 361	ZLE 288
1.8 16V T.SPARK	1.7	106	09.97–10.00	AR 32201	4	ZS 361	ZLE 288
2.0 16V T.SPARK	2.0	110	10.00–03.02	AR 32310	4	ZS 361	ZLE 288
2.0 16V T.SPARK	2.0	114	09.97–10.00	AR 32301	4	ZS 309	ZLE 288
2.0 JTS	2.0	122	03.02–09.05	937 A1.000	4	ZSE 148	
2.5 V6 24V	2.5	140	09.97–12.01	AR 32401/AR 32402	6	ZS 428	
2.5 V6 24V	2.5	141	10.00–09.05	AR 32405	6	ZS 428	
3.2 GTA	3.2	184	03.02–09.05	932 A.000	6	ZS 428	

**156 Sportwagon**

1.6 16V T.SPARK.	1.6	88	05.00–05.06	AR 32102/AR 32103/AR 32104/AR 67601	4	ZS 361	ZLE 288
1.8 16V T.SPARK	1.7	103	10.00–05.06	AR 32205	4	ZS 361	ZLE 288
1.8 16V T.SPARK	1.7	106	05.00–10.00	AR 32201	4	ZS 361	ZLE 288
2.0	2.0	119	03.02–05.06	932 A2.000	4	ZSE 148	
2.0 16V T.SPARK	2.0	110	10.00–03.02	AR 32310	4	ZS 361	ZLE 288
2.0 16V T.SPARK	2.0	114	05.00–10.00	AR 32301	4	ZS 361	ZLE 288
2.0 JTS	2.0	122	03.02–05.06	937 A1.000	4	ZSE 148	
2.5 V6 24V	2.5	140	05.00–10.00	AR 32401	6	ZS 428	
2.5 V6 24V	2.5	141	10.00–05.06	AR 32405	6	ZS 428	
3.2 GTA	3.2	184	03.02–05.06	932 A.000	6	ZS 428	

**159**

1.8 MPI	1.8	103	03.07–11.11	939 A4.000	4	ZS 427	
1.8 Tbi	1.7	147	05.09–11.11	939 B1.000	4	ZS 427	



kW

**ALFA ROMEO****159 Sportwagon**

1.8 MPI	1.8	103	03.07–11.11	939 A4.000	4		ZS 427	
1.8 TBi	1.7	147	05.09–11.11	939 B1.000	4		ZS 427	

**164**

2.0 T.S.	2.0	106	09.92–09.98	AR 64103	4		ZS 234	
2.0 V6 Turbo	2.0	148	09.92–09.98	AR 64102	6	ZM 035	ZS 122	
2.0 V6 Turbo	2.0	150	03.91–09.92	AR 64101	6		ZS 122	
2.5 V6	2.5	120	09.92–09.98	AR 66201	6		ZS 428	
3.0	3.0	145	10.94–08.97	AR 64399	6		ZS 428	
3.0	3.0	157	03.95–10.97	AR 66306	6		ZS 428	
3.0	3.0	168	04.93–02.95	AR 64304	6		ZS 428	
3.0	3.0	170	03.95–08.97	AR 64304	6		ZS 428	
3.0 24V	3.0	155	09.92–09.98	AR 66301/AR 66302	6		ZS 428	
3.0 24V Q4	3.0	170	02.94–09.98	AR 64308/AR 64307	6		ZS 428	
3.0 24V QV	3.0	171	09.92–09.98	AR 64304	6		ZS 428	
3.0 Allrad	3.0	171	11.92–10.97	AR 64307	6		ZS 428	
3.0 V6	3.0	132	09.92–09.98	AR 66303/AR 64305	6		ZS 230	

**166**

2.0 T.Spark	2.0	110	10.00–06.07	AR 36301	4		ZS 361	ZLE 288
2.0 T.Spark	2.0	114	09.98–10.00	AR 34103	4		ZS 309	ZLE 288
2.5 V6 24V	2.5	138	10.00–06.07	AR 36201	6		ZS 428	
2.5 V6 24V	2.5	140	09.98–10.00	AR 34201	6		ZS 428	
3.0 V6 24V	3.0	162	10.00–06.07	AR 36101	6		ZS 428	
3.0 V6 24V	3.0	166	09.98–10.00	AR 34301	6		ZS 428	
3.2 V6 24V	3.2	176	10.03–06.07	936 A.000	6		ZS 428	

**33 (905)**

1.5	1.5	62	06.83–12.85	AR30504	4	ZM 001		
1.5	1.5	66	06.83–12.86	AR 30520	4	ZM 001		
1.5 4x4	1.5	62	11.83–12.84	AR 30504	4	ZM 001		
1.5 4x4	1.5	66	01.85–09.86	AR 30520	4	ZM 001		
1.5 4x4	1.5	77	09.88–12.89	AR30588	4	ZM 003		
1.5 QV	1.5	77	09.88–12.89	AR30508	4	ZM 003		

**33 (907A)**

1.5	1.5	77	01.90–04.93	AR30508	4	ZM 003		
1.5 i.e.	1.5	74	07.90–08.91	AR 30750	4	ZM 001		
1.7 i.e.	1.7	77	04.92–09.94	AR 30737 A	4	ZM 026		

**33 Sportwagon (905A)**

1.5	1.5	77	03.88–12.89	AR30508	4	ZM 001		
1.5 4x4	1.5	77	03.88–03.89	AR30508	4	ZM 001		
1.7	1.7	87	03.88–12.89	AR 30550	4	ZM 001		
1.7 i.e.	1.7	77	09.88–12.89	AR 30558	4	ZM 003		
1.7 i.e. 4x4	1.7	77	09.88–12.89	AR 30558/AR 30737	4	ZM 003		

**33 Sportwagon (907B)**

1.7 i.e.	1.7	77	04.92–09.94	AR 30737	4	ZM 026		
1.7 i.e.	1.7	79	01.90–03.92	AR 30736/AR 30737	4	ZM 001		
1.7 i.e. 4x4	1.7	79	01.90–03.92	AR 30736/AR 30737	4	ZM 001		

**75**

1.6	1.6	81	05.85–09.89	AR 06100	4	ZM 001		
1.8	1.8	85	09.85–06.89	AR 06202	4	ZM 001		
1.8 Turbo	1.8	110	09.86–01.90	AR 06134	4	ZM 001		
2.0	2.0	94	05.85–10.88	AR 06212	4	ZM 001		
2.0 T.S KAT	2.0	109	05.85–02.92	AR 06224	4	ZM 037		
2.0 T.S.	2.0	107	01.87–02.92	AR 06166/AR 06224	4	ZM 037		
2.0 T.S.	2.0	109	01.87–12.88	AR 06224	4	ZM 037		
2.5 V6	2.5	115	02.86–08.86	AR01911	6	ZM 001		
3.0 V6	3.0	136	01.87–12.90	AR 06120	6	ZM 001		
3.0 V6 KAT	3.0	136	01.87–02.92	AR 06124	6	ZM 001		

**90**

2.5 i.e. V6	2.5	110	02.86–01.87	AR01646 , AR01911	6	ZM 001		
-------------	-----	-----	-------------	-------------------	---	--------	--	--

**ALFETTA**

2.0	2.0	97	10.81–12.84	AR01655	4	ZM 001		
-----	-----	----	-------------	---------	---	--------	--	--



kW

**ALFA ROMEO**

<b>ARNA</b>								
1.2	1.2	44	01.85–12.86	AR 31000	4	<b>ZM 005</b>	<b>ZS 106</b>	
1.2	1.2	46	03.83–12.86	AR 30102	4	<b>ZM 005</b>		
1.2	1.2	50	01.85–12.86	AR 30500	4	<b>ZM 005</b>		
1.3 TI	1.4	63	09.83–12.84	AR31010	4	<b>ZM 001</b>		
<b>GIULIETTA</b>								
1.4 TB	1.4	88	04.10–	198 A4.000	4		<b>ZS 095</b>	
1.6	1.6	79	01.81–04.85	AR 01600	4	<b>ZM 005</b>		
1.8	1.8	90	10.81–04.85	AR 01678	4	<b>ZM 001</b>		
1.8	1.8	90	01.81–04.85	AR 01678	4	<b>ZM 005</b>		
1.8 Turbo	1.8	110	01.84–04.85	AR 01354	4	<b>ZM 005</b>		
2.0	2.0	96	01.81–04.85	AR 11671/AR 01655	4	<b>ZM 005</b>		
1.4 TB	1.4	88	04.10–	198 A4.000	4		<b>ZS 095</b>	
<b>GT</b>								
1.8 TS	1.7	103	11.03–09.10	AR 32205	4		<b>ZS 361</b>	<b>ZLE 288</b>
2.0 JTS	2.0	119	12.06–09.10	932 A2.000	4		<b>ZSE 148</b>	
2.0 JTS	2.0	121	11.03–09.10	932 A2.000/937 A1.000	4		<b>ZSE 148</b>	
3.2 GTA	3.2	176	11.03–09.10	936 A.000	6		<b>ZS 428</b>	
<b>GTV (116)</b>								
2.0	2.0	96	07.78–01.86	AR 06212/AR 01655	4		<b>ZS 115</b>	
2.0	2.0	94	01.85–12.85	AR 06212	4		<b>ZS 115</b>	
6 2.5	2.5	116	11.80–02.87	AR 01646	6		<b>ZS 115</b>	
<b>GTV (916C_)</b>								
2.0 JTS	2.0	121	04.03–10.05	937 A1.000	4		<b>ZSE 148</b>	
2.0 V6 Turbo	2.0	148	06.95–09.98	AR 16202	6	<b>ZM 035</b>	<b>ZS 122</b>	
3.0 V6 24V	3.0	160	10.00–10.05	AR 16105	6		<b>ZS 428</b>	
3.0 V6 24V	3.0	162	10.96–10.00	AR 16102	6		<b>ZS 428</b>	
3.2 V6 24V	3.2	176	04.03–10.05	936 A6.000	6		<b>ZS 428</b>	
<b>MITO</b>								
1.4	1.4	51	05.11–	955 A9.000	4		<b>ZS 079</b>	
1.4	1.4	57	03.11–	350 A1.000	4		<b>ZS 322</b>	
1.4	1.4	58	09.08–	955 A1.000	4		<b>ZS 322</b>	
1.4	1.4	70	09.08–	199 A6.000	4		<b>ZS 322</b>	
1.4	1.4	88	09.08–	198 A4.000	4		<b>ZS 095</b>	
1.4 Bifuel	1.4	88	07.11–	198 A4.000	4		<b>ZS 095</b>	
1.4 TB	1.4	114	09.08–	199 A8.000	4		<b>ZS 095</b>	
<b>SPIDER (115)</b>								
1600	1.6	76	03.76–12.90	AR 00526	4		<b>ZS 106</b>	
<b>SPIDER (916S_)</b>								
2.0 JTS	2.0	121	04.03–04.05	937 A1.000	4		<b>ZSE 148</b>	
2.0 T.SPARK 16V	2.0	110	06.95–04.98	AR 16201	4		<b>ZS 309</b>	<b>ZLE 288</b>
2.0 T.SPARK 16V	2.0	110	08.00–04.05	AR 16201/AR 32310	4		<b>ZS 361</b>	<b>ZLE 288</b>
2.0 V6 Turbo	2.0	148	05.98–12.00	AR 16202	6		<b>ZS 122</b>	
3.0 V6	3.0	141	04.95–04.98		6		<b>ZS 230</b>	
3.0 V6	3.0	141	06.95–04.05	AR 16101	6		<b>ZS 230</b>	
3.0 V6	3.0	160	10.00–04.05	AR 16105	6		<b>ZS 428</b>	
3.0 V6 24V	3.0	162	01.99–10.00	AR 16102	6		<b>ZS 428</b>	
3.2 V6 24V	3.2	176	04.03–04.05	936 A6.000	6		<b>ZS 428</b>	

**ALPINA**

<b>ROADSTER (Z8)</b>								
4.8 V8	4.8	280	06.02–10.03		8		<b>ZS 302</b>	

**ALPINE**

<b>A310</b>								
2.7 V6	2.7	110	01.76–12.84		6		<b>ZS 110</b>	
2.7 V6	2.7	110	01.81–12.84		6		<b>ZS 400</b>	
<b>A610</b>								
3.0 TURBO	3.0	184	01.91–04.95		6		<b>ZS 251</b>	
<b>V6</b>								
2.5 TURBO	2.5	136	06.87–12.90	Z7U-734	6		<b>ZS 251</b>	
2.5 TURBO	2.5	147	01.88–12.90	Z7U	6		<b>ZS 251</b>	





kW



**ASTON MARTIN**

<b>DB7 Vantage</b>								
3.2	3.2	250	01.94–10.03		8	<b>ZM 047</b>		
5.9	5.9	309	03.99–10.03	AM2	12	<b>ZM 047</b>		
<b>DB7 Volante</b>								
3.2	3.2	250	01.96–10.03	AJ6HT	6	<b>ZM 047</b>		
5.9	5.9	309	03.99–10.03	AM2	12	<b>ZM 047</b>		
<b>DB9 Vantage</b>								
4.2 V8	4.3	283	06.05–	AM6U5	8		<b>ZS 389</b>	
5.9 V12	5.9	331	01.04–		12		<b>ZS 426</b>	
<b>DB9 Volante</b>								
5.9	5.9	331	04.04–07.12		12		<b>ZS 426</b>	
<b>VIRAGE Limited Edition</b>								
5.3	5.3	246	01.95–12.95	40HTE	8	<b>ZM 047</b>		
<b>VIRAGE Saloon</b>								
5.3	5.3	246	01.94–12.95	40HTE	8	<b>ZM 047</b>		
6.3	6.3	246	01.95–12.95		8	<b>ZM 047</b>		
<b>VIRAGE Shooting Brake</b>								
5.3	5.3	246	01.93–12.95	40HTE	8	<b>ZM 047</b>		
6.3	6.3	373	01.94–12.95	63TK4	8	<b>ZM 047</b>		
<b>VIRAGE Vantage</b>								
5.3	5.3	410	10.92–10.00		8	<b>ZM 047</b>		
<b>VIRAGE Volante</b>								
5.3	5.3	246	09.90–12.95	40HTE	8	<b>ZM 047</b>		
6.3	6.3	373	09.90–12.95	63TK4	8	<b>ZM 047</b>		

**AUDI**

<b>A1 (8X1)</b>								
1.2 TFSI	1.2	63	05.10–	CBZA	4		<b>ZSE 003</b>	
1.4 TFSI	1.4	90	05.10–01.12	CAXA , CNVA	4		<b>ZSE 030</b>	
1.4 TFSI	1.4	103	04.12–	CPTA	4		<b>ZSE 067<sup>202</sup></b>	
1.4 TFSI	1.4	103	04.12–	CPTA	4		<b>ZSE 126<sup>202</sup></b>	
1.4 TFSI	1.4	136	01.11–01.12	CAVG , CTHG , CTJA	4		<b>ZSE 030</b>	
2.0 TFSI quattro	2.0	188	03.12–	CDLH	4		<b>ZSE 033</b>	
<b>A1 Sportback (8XA)</b>								
1.2 TFSI	1.2	63	01.12–	CBZA	4		<b>ZSE 003</b>	
1.4 TFSI	1.4	90	11.11–	CAXA	4		<b>ZSE 030</b>	
1.4 TFSI	1.4	103	04.12–	CPTA	4		<b>ZSE 067<sup>202</sup></b>	
1.4 TFSI	1.4	103	04.12–	CPTA	4		<b>ZSE 126<sup>202</sup></b>	
<b>A2 (8Z0)</b>								
1.4	1.4	55	02.00–08.05	AUA	4		<b>ZSE 003</b>	
1.4	1.4	55	02.00–08.05	BBY	4		<b>ZSE 030</b>	
1.6 FSI	1.6	81	05.02–08.05	BAD	4		<b>ZSE 030</b>	
<b>A3 (8L1)</b>								
1.6	1.6	74	09.96–05.03	AKL/APF/AEH	4		<b>ZSE 003</b>	
1.6	1.6	75	08.00–05.03	AVU/BFQ	4		<b>ZSE 003</b>	
1.8	1.8	92	09.96–05.03	AGN/APG	4		<b>ZSE 003</b>	
1.8 T	1.8	110	12.96–04.01	AGU	4	<b>ZM 062</b>	<b>ZS 016</b>	<b>ZLE 276</b>
1.8 T	1.8	110	12.96–05.03	AQA , ARZ	4		<b>ZSE 009</b>	
1.8 T	1.8	110	05.01–05.03	AUM , AGU	4		<b>ZSE 043</b>	
1.8 T	1.8	132	12.98–05.03	AJQ , APP	4		<b>ZSE 009</b>	
1.8 T	1.8	132	12.98–05.03	ARY , AUQ	4		<b>ZSE 043</b>	
1.8 T quattro	1.8	110	08.98–04.01	AQA	4		<b>ZSE 009</b>	
1.8 T quattro	1.8	110	12.96–05.03	ARX	4		<b>ZSE 043</b>	
1.8 T quattro	1.8	110	12.96–07.98	AGU	4	<b>ZM 062</b>	<b>ZS 016</b>	<b>ZLE 276</b>
1.8 T quattro	1.8	132	09.00–05.03	ARY	4		<b>ZSE 043</b>	
1.8 T quattro	1.8	132	10.98–08.00	AJQ	4		<b>ZSE 009</b>	
S3 quattro	1.8	154	09.00–04.02	AMK	4		<b>ZSE 043</b>	
S3 quattro	1.8	165	10.01–05.03	BAM	4		<b>ZSE 043</b>	
<b>A3 (8P1)</b>								
1.2 TSI	1.2	77	04.10–08.12	CBZB	4		<b>ZSE 003</b>	
1.4 TFSI	1.4	92	09.07–08.12	CMSA/CAXC	4		<b>ZSE 030</b>	
1.6	1.6	75	05.03–08.12	BGU/CCSA/BSF/CMXA/BSE	4		<b>ZSE 003</b>	



kW

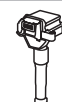

AUDI							
<b>A3 (8P1)</b>							
1.6 E-Power	1.6	75	01.11–08.12	CMXA	4		ZSE 003
1.6 FSI	1.6	85	08.03–09.07	BLF/BLP/BAG	4		ZSE 030
1.8 TFSI	1.8	118	11.06–08.12	BZB/CDA/AYT	4		ZSE 033 <sup>202</sup>
1.8 TFSI	1.8	118	11.06–08.12	BZB/CDA/AYT	4		ZSE 142 <sup>202</sup>
1.8 TFSI quattro	1.8	118	07.08–08.12	CDA	4		ZSE 033 <sup>202</sup>
1.8 TFSI quattro	1.8	118	07.08–08.12	CDA	4		ZSE 142 <sup>202</sup>
2.0 FSI	2.0	110	05.03–06.08	BLX/BLY/BMB/BLR/AXW/BVZ/BVY	4		ZSE 033 <sup>202</sup>
2.0 FSI	2.0	110	05.03–06.08	BLX/BLY/BMB/BLR/AXW/BVZ/BVY	4		ZSE 142 <sup>202</sup>
2.0 TFSI	2.0	147	09.04–08.12	BWA/AXX/CCZA/CAWB	4		ZSE 033 <sup>202</sup>
2.0 TFSI	2.0	147	09.04–08.12	BWA/AXX/CCZA/CAWB	4		ZSE 142 <sup>202</sup>
2.0 TFSI quattro	2.0	147	09.04–08.12	BWA/AXX/CCZA	4		ZSE 033 <sup>202</sup>
2.0 TFSI quattro	2.0	147	09.04–08.12	BWA/AXX/CCZA	4		ZSE 142 <sup>202</sup>
3.2 V6 quattro	3.2	184	07.03–05.09	BDB/BMJ/BUB	6		ZSE 044
S3 quattro	2.0	188	02.07–08.12	BZC/CDLC	4		ZSE 033 <sup>202</sup>
S3 quattro	2.0	188	02.07–08.12	BZC/CDLC	4		ZSE 142 <sup>202</sup>
S3 quattro	2.0	195	11.06–08.12	BHZ/CDLA	4		ZSE 033 <sup>202</sup>
S3 quattro	2.0	195	11.06–08.12	BHZ/CDLA	4		ZSE 142 <sup>202</sup>
<b>A3 (8V1)</b>							
1.4 TFSI	1.4	103	10.12–	CPTA	4		ZSE 067 <sup>202</sup>
1.4 TFSI	1.4	103	10.12–	CPTA	4		ZSE 126 <sup>202</sup>
1.8 TFSI	1.8	132	04.12–	CJSA	4		ZSE 068
1.8 TFSI quattro	1.8	132	08.12–	CJSB	4		ZSE 068
S3 quattro	2.0	206	02.13–	CJXB	4		ZSE 068
S3 quattro	2.0	221	11.12–	CJXC	4		ZSE 068
<b>A3 Cabriolet (8P7)</b>							
1.2 TFSI	1.2	77	03.10–	CBZB	4		ZSE 003
1.4 TFSI	1.4	92	02.11–01.12	CAXC	4		ZSE 030
1.6	1.6	75	09.08–	BSE	4		ZSE 003
1.8 TFSI	1.8	118	04.08–	BZB/CDA	4		ZSE 033 <sup>202</sup>
1.8 TFSI	1.8	118	04.08–	BZB/CDA	4		ZSE 142 <sup>202</sup>
2.0 TFSI	2.0	147	04.08–	CCZA/CAWB	4		ZSE 033 <sup>202</sup>
2.0 TFSI	2.0	147	04.08–	CCZA/CAWB	4		ZSE 142 <sup>202</sup>
<b>A3 Sportback (8PA)</b>							
1.2 TSI	1.2	77	04.10–	CBZB	4		ZSE 003
1.4 TFSI	1.4	92	09.07–	CMSA/CAXC	4		ZSE 030
1.6	1.6	75	09.04–	BGU/CCSA/BSF/CMXA/BSE	4		ZSE 003
1.6 E-Power	1.6	75	01.11–	CMXA	4		ZSE 003
1.6 FSI	1.6	85	09.04–	BLF/BLP	4		ZSE 030
1.8 TFSI	1.8	118	11.06–	BZB/CDA/AYT	4		ZSE 033 <sup>202</sup>
1.8 TFSI	1.8	118	11.06–	BZB/CDA/AYT	4		ZSE 142 <sup>202</sup>
1.8 TFSI quattro	1.8	118	07.08–	CDA	4		ZSE 033 <sup>202</sup>
1.8 TFSI quattro	1.8	118	07.08–	CDA	4		ZSE 142 <sup>202</sup>
2.0 FSI	2.0	110	09.04–	BLX/BLY/BMB/BLR/BVZ/BVY	4		ZSE 033 <sup>202</sup>
2.0 FSI	2.0	110	09.04–	BLX/BLY/BMB/BLR/BVZ/BVY	4		ZSE 142 <sup>202</sup>
2.0 TFSI	2.0	147	09.04–	BWA/BPY/AXX/CBFA/CCZA/CAWB	4		ZSE 033 <sup>202</sup>
2.0 TFSI	2.0	147	09.04–	BWA/BPY/AXX/CCZA/CBFA/CAWB	4		ZSE 142 <sup>202</sup>
2.0 TFSI quattro	2.0	147	09.04–	BWA/AXX/CCZA	4		ZSE 033 <sup>202</sup>
2.0 TFSI quattro	2.0	147	09.04–	BWA/AXX/CCZA	4		ZSE 142 <sup>202</sup>
3.2 V6 quattro	3.2	184	09.04–05.09	BMJ/BUB	6		ZSE 044
RS3 quattro	2.5	250	04.11–	CEPA	5		ZSE 033
S3 quattro	2.0	188	07.08–	CDLC	4		ZSE 033 <sup>202</sup>
S3 quattro	2.0	188	07.08–	CDLC	4		ZSE 142 <sup>202</sup>
S3 quattro	2.0	195	06.08–	BHZ/CDLA	4		ZSE 033 <sup>202</sup>
S3 quattro	2.0	195	06.08–	BHZ/CDLA	4		ZSE 142 <sup>202</sup>
<b>A3 Sportback (8VA)</b>							
1.4 TFSI	1.4	103	03.13–	CPTA	4		ZSE 067 <sup>202</sup>
1.4 TFSI	1.4	103	03.13–	CPTA	4		ZSE 126 <sup>202</sup>
1.8 TFSI	1.8	132	03.13–	CJSA	4		ZSE 068
<b>A4 (8D2, B5)</b>							
1.6	1.6	74	11.94–10.00	AHL,ANA,ARM	4		ZSE 003
1.6	1.6	74	11.94–10.00	ADP	4		ZSE 006



kW



## AUDI

## A4 (8D2, B5)

1.6	1.6	75	07.00–11.00	ALZ	4		ZSE 003	
1.8	1.8	85	04.95–11.00	AFY	4		ZS 016	ZLE 276
1.8 quattro	1.8	85	07.95–11.00	AFY	4		ZS 016	ZLE 276
1.8 T	1.8	110	01.97–11.00	ARK/AEB/ANB/APU/AWT	4	ZM 028		
1.8 T	1.8	110	01.97–11.00	ARK/AEB/ANB/APU/AWT	4	ZM 062		
1.8 T	1.8	110	01.95–11.00	AEB, ANB, APU, ARK	4		ZS 016	ZLE 276
1.8 T	1.8	110	06.00–11.00	AWT	4		ZSE 043	
1.8 T	1.8	132	12.97–12.98	AJL	4	ZM 028	ZS 016	ZLE 276
1.8 T	1.8	132	12.97–12.98	AJL	4	ZM 062	ZS 016	ZLE 276
1.8 T quattro	1.8	110	01.97–11.00	ARK/AEB/ANB/APU/AWT	4	ZM 028		
1.8 T quattro	1.8	110	01.97–11.00	ARK/AEB/ANB/APU/AWT	4	ZM 062		
1.8 T quattro	1.8	110	01.95–11.00	AEB, ANB, APU, ARK	4		ZS 016	ZLE 276
1.8 T quattro	1.8	132	12.97–11.00	AJL	4		ZS 016	ZLE 276
1.8 T quattro	1.8	132	12.97–12.98	AJL	4	ZM 028		
1.8 T quattro	1.8	132	12.97–12.98	AJL	4	ZM 062		
2.6	2.6	110	01.95–11.00	ABC	6	ZM 027	ZSE 008	
2.6	2.6	110	01.95–11.00	ABC	6	ZM 063	ZSE 008	
2.6 quattro	2.6	110	01.95–11.00	ABC	6	ZM 027	ZSE 008	
2.6 quattro	2.6	110	01.95–11.00	ABC	6	ZM 063	ZSE 008	
2.8	2.8	128	09.95–07.97	AAH	6	ZM 027	ZSE 008	
2.8	2.8	128	09.95–07.97	AAH	6	ZM 063	ZSE 008	
2.8 quattro	2.8	128	01.95–07.97	AAH	6	ZM 027	ZSE 008	
2.8 quattro	2.8	128	01.95–07.97	AAH	6	ZM 063	ZSE 008	
S4 quattro	2.7	195	09.97–11.00	AGB/AZB	6		ZS 016	ZLE 276

## A4 (8E2, B6)

1.6	1.6	75	11.00–12.04	ALZ	4		ZSE 003	
1.8 T	1.8	110	11.00–07.02	AVJ	4		ZSE 043	
1.8 T	1.8	120	07.02–02.04	BFB Fgst.Nr. →8E..4..227922	4		ZSE 043	
1.8 T	1.8	140	11.02–12.04	BEX	4		ZSE 043	
1.8 T quattro	1.8	140	11.02–12.04	BEX	4		ZSE 043	
2.0	2.0	96	11.00–12.04	ALT	4		ZSE 043	
2.0	2.0	96	11.00–12.04	ALT	4		ZSE 051	
2.0 FSI	2.0	110	07.02–12.04	AWA	4		ZSE 032 <sup>202</sup>	
2.0 FSI	2.0	110	07.02–12.04	AWA	4		ZSE 142 <sup>202</sup>	
3.0	3.0	160	04.01–12.04	BBJ	6		ZSE 051	
3.0	3.0	162	11.00–12.04	ASN/AVK	6		ZSE 051	
3.0 quattro	3.0	160	04.01–12.04	BBJ	6		ZSE 051	
3.0 quattro	3.0	162	11.00–12.04	ASN/AVK	6		ZSE 051	
S4 quattro	4.2	253	03.03–12.04	BBK	8		ZSE 061	

## A4 (8EC, B7)

1.6	1.6	75	11.04–06.08	ALZ	4		ZSE 003	
1.8 T	1.8	120	11.04–06.08	BFB	4		ZSE 043	
2.0	2.0	96	11.04–06.08	ALT	4		ZSE 043	
2.0 TFSI	2.0	125	10.06–06.08	BPJ/BYK	4		ZSE 142 <sup>202</sup>	
2.0 TFSI	2.0	147	11.04–06.08	BPG/BWT/BGB/BWE	4		ZSE 033 <sup>202</sup>	
2.0 TFSI	2.0	147	11.04–06.08	BPG/BWT/BGB/BWE	4		ZSE 142 <sup>202</sup>	
2.0 TFSI	2.0	162	06.05–06.08	BUL	4		ZSE 033 <sup>202</sup>	
2.0 TFSI	2.0	162	06.05–06.08	BUL	4		ZSE 142 <sup>202</sup>	
2.0 TFSI quattro	2.0	147	11.04–06.08	BPG/BWT/BGB/BWE	4		ZSE 033 <sup>202</sup>	
2.0 TFSI quattro	2.0	147	11.04–06.08	BPG/BWT/BGB/BWE	4		ZSE 142 <sup>202</sup>	
2.0 TFSI quattro	2.0	162	06.05–06.08	BUL	4		ZSE 033 <sup>202</sup>	
2.0 TFSI quattro	2.0	162	06.05–06.08	BUL	4		ZSE 142 <sup>202</sup>	
3.2 FSI	3.1	188	01.05–06.08	AUK	6		ZSE 032	
3.2 FSI quattro	3.1	188	01.05–06.08	AUK/BKH	6		ZSE 032	
RS4 quattro	4.2	309	09.05–06.08	BNS	8		ZSE 142 <sup>202</sup>	
S4 quattro	4.2	253	11.04–06.08	BBK	8		ZSE 061	

## A4 (8K2, B8)

1.8 TFSI	1.8	88	01.08–	CABA/CDHA	4		ZSE 033 <sup>202</sup>	
1.8 TFSI	1.8	88	01.08–	CABA/CDHA	4		ZSE 142 <sup>202</sup>	
1.8 TFSI	1.8	118	11.07–	CDHB/CCUA/CABB	4		ZSE 033 <sup>202</sup>	



kW

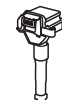
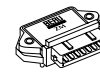

## AUDI

## A4 (8K2, B8)

1.8 TFSI	1.8	118	11.07-	CDHB/CCUA/CABB	4		ZSE 142 <sup>202</sup>	
1.8 TFSI	1.8	125	11.11-	CJEB	4		ZSE 137	
1.8 TFSI quattro	1.8	118	09.08-	CDHB	4		ZSE 033 <sup>202</sup>	
1.8 TFSI quattro	1.8	118	09.08-	CDHB	4		ZSE 142 <sup>202</sup>	
1.8 TFSI quattro	1.8	125	11.11-	CJEB	4		ZSE 137	
2.0 TFSI	2.0	132	06.08-	CDNB/CAEA/CDZA	4		ZSE 033 <sup>202</sup>	
2.0 TFSI	2.0	132	06.08-	CDNB/CAEA/CDZA	4		ZSE 142 <sup>202</sup>	
2.0 TFSI	2.0	155	06.08-	CAEB/CDNC/CADA	4		ZSE 033 <sup>202</sup>	
2.0 TFSI	2.0	155	06.08-	CAEB/CDNC/CADA	4		ZSE 142 <sup>202</sup>	
2.0 TFSI flexible fuel	2.0	132	11.09-	CFKA	4		ZSE 033 <sup>202</sup>	
2.0 TFSI flexible fuel	2.0	132	11.09-	CFKA	4		ZSE 142 <sup>202</sup>	
2.0 TFSI flexible fuel quattro	2.0	132	11.09-	CFKA	4		ZSE 033 <sup>202</sup>	
2.0 TFSI flexible fuel quattro	2.0	132	11.09-	CFKA	4		ZSE 142 <sup>202</sup>	
2.0 TFSI quattro	2.0	155	06.08-	CAEB/CPMA/CDNC	4		ZSE 033 <sup>202</sup>	
2.0 TFSI quattro	2.0	155	06.08-	CAEB/CPMA/CDNC	4		ZSE 142 <sup>202</sup>	
3.2 FSI	3.2	195	09.08-	CALA	6		ZSE 032	
3.2 FSI quattro	3.2	195	11.07-	CALA	6		ZSE 032	
S4 quattro	3.0	245	11.08-	CGWC/CAKA/CCBA/CGXC	6		ZSE 032	

## A4 Allroad (8KH, B8)

2.0 TFSI quattro	2.0	155	04.09-	CPMA/CDNC	4		ZSE 033 <sup>202</sup>	
2.0 TFSI quattro	2.0	155	04.09-	CPMA/CDNC	4		ZSE 142 <sup>202</sup>	

## A4 Avant (8D5, B5)

1.6	1.6	74	11.94-09.01	AHL,ANA,ARM	4		ZSE 003	
1.6	1.6	74	11.94-09.01	ADP	4		ZSE 006	
1.6	1.6	75	07.00-09.01	ALZ	4		ZSE 003	
1.8 T	1.8	110	01.97-09.01	ARK/AEB/ANB/APU/AWT	4	ZM 028		
1.8 T	1.8	110	01.97-09.01	ARK/AEB/ANB/APU/AWT	4	ZM 062		
1.8 T	1.8	110	03.96-09.01	AEB, ANB, APU, ARK	4		ZS 016	ZLE 276
1.8 T	1.8	110	03.96-09.01	AWT	4		ZSE 043	
1.8 T	1.8	132	12.97-12.98	AJL	4	ZM 028		
1.8 T	1.8	132	12.97-12.98	AJL	4	ZM 062		
1.8 T quattro	1.8	110	01.97-09.01	ARK/AEB/ANB/APU/AWT	4	ZM 028		
1.8 T quattro	1.8	110	01.97-09.01	ARK/AEB/ANB/APU/AWT	4	ZM 062		
1.8 T quattro	1.8	110	01.96-09.01	AEB, ANB, APU, ARX	4		ZS 016	ZLE 276
1.8 T quattro	1.8	132	12.97-12.98	AJL	4	ZM 028		
1.8 T quattro	1.8	132	12.97-12.98	AJL	4	ZM 062		
2.6	2.6	110	02.96-09.01	ABC	6	ZM 027	ZSE 008	
2.6	2.6	110	02.96-09.01	ABC	6	ZM 063	ZSE 008	
2.6 quattro	2.6	110	01.96-09.01	ABC	6	ZM 027	ZSE 008	
2.6 quattro	2.6	110	01.96-09.01	ABC	6	ZM 063	ZSE 008	
2.8	2.8	128	03.96-09.96	AAH	6	ZM 027	ZSE 008	
2.8	2.8	128	03.96-09.96	AAH	6	ZM 063	ZSE 008	
2.8 quattro	2.8	128	01.96-09.96	AAH	6	ZM 027	ZSE 008	
2.8 quattro	2.8	128	01.96-09.96	AAH	6	ZM 063	ZSE 008	
RS4 quattro	2.7	280	05.00-09.01	ASJ, AZR	6		ZS 016	ZLE 276

## A4 Avant (8E5, B6)

1.6	1.6	75	09.01-12.04	ALZ	4		ZSE 003	
1.8 T	1.8	110	09.01-07.02	AVJ Fgst.Nr.8E-1-000 001→ Fgst.Nr.→8E-5-400 000	4		ZSE 043	
1.8 T	1.8	120	07.02-12.04	BFB	4		ZSE 043	
1.8 T	1.8	140	11.02-12.04	BEX	4		ZSE 043	
1.8 T quattro	1.8	120	07.02-12.04	BFB	4		ZSE 043	
1.8 T quattro	1.8	140	11.02-12.04	BEX	4		ZSE 043	
2.0	2.0	96	09.01-12.04	ALT	4		ZSE 051	
2.0 FSI	2.0	110	07.02-12.04	AWA	4		ZSE 032 <sup>202</sup>	
2.0 FSI	2.0	110	07.02-12.04	AWA	4		ZSE 142 <sup>202</sup>	
3.0	3.0	160	04.01-12.04	BBJ	6		ZSE 051	
3.0	3.0	162	09.01-12.04	ASN	6		ZSE 051	
3.0 quattro	3.0	160	04.01-12.04	BBJ	6		ZSE 051	
3.0 quattro	3.0	162	09.01-12.04	ASN/AVK	6		ZSE 051	
S4 quattro	4.2	253	03.03-12.04	BBK	8		ZSE 061	



kW

**AUDI****A4 Avant (8ED, B7)**

1.6	1.6	75	11.04–06.08	ALZ	4	<b>ZSE 003</b>
1.8 T	1.8	120	11.04–06.08	BFB	4	<b>ZSE 043</b>
2.0	2.0	96	11.04–06.08	ALT	4	<b>ZSE 043</b>
2.0 TFSI	2.0	125	10.06–06.08	BPJ/BYK	4	<b>ZSE 142</b> <sup>202</sup>
2.0 TFSI	2.0	147	11.04–06.08	BGB/BWE	4	<b>ZSE 033</b> <sup>202</sup>
2.0 TFSI	2.0	147	11.04–06.08	BGB/BWE	4	<b>ZSE 142</b> <sup>202</sup>
2.0 TFSI	2.0	162	06.05–06.08	BUL	4	<b>ZSE 033</b> <sup>202</sup>
2.0 TFSI	2.0	162	06.05–06.08	BUL	4	<b>ZSE 142</b> <sup>202</sup>
2.0 TFSI quattro	2.0	147	11.04–06.08	BGB/BWE	4	<b>ZSE 033</b> <sup>202</sup>
2.0 TFSI quattro	2.0	147	11.04–06.08	BWT/BGB/BWE	4	<b>ZSE 142</b> <sup>202</sup>
2.0 TFSI quattro	2.0	162	06.05–06.08	BUL	4	<b>ZSE 033</b> <sup>202</sup>
2.0 TFSI quattro	2.0	162	06.05–06.08	BUL	4	<b>ZSE 142</b> <sup>202</sup>
3.2 FSI	3.1	188	01.05–06.08	AUK	6	<b>ZSE 032</b>
3.2 FSI quattro	3.1	188	01.05–06.08	AUK	6	<b>ZSE 032</b>
RS4 quattro	4.2	309	09.05–06.08	BNS	8	<b>ZSE 142</b> <sup>202</sup>
S4 quattro	4.2	253	11.04–06.08	BBK	8	<b>ZSE 061</b>

**A4 Avant (8K5, B8)**

1.8 TFSI	1.8	88	04.08–	CDHA	4	<b>ZSE 033</b> <sup>202</sup>
1.8 TFSI	1.8	88	04.08–	CDHA	4	<b>ZSE 142</b> <sup>202</sup>
1.8 TFSI	1.8	118	04.08–	CDHB/CCUA/CABB	4	<b>ZSE 033</b> <sup>202</sup>
1.8 TFSI	1.8	118	11.07–	CDHB/CCUA/CABB	4	<b>ZSE 142</b> <sup>202</sup>
1.8 TFSI	1.8	125	11.11–	CJEB	4	<b>ZSE 137</b>
1.8 TFSI quattro	1.8	118	09.08–	CDHB	4	<b>ZSE 033</b> <sup>202</sup>
1.8 TFSI quattro	1.8	118	09.08–	CDHB	4	<b>ZSE 142</b> <sup>202</sup>
1.8 TFSI quattro	1.8	125	11.11–	CJEB	4	<b>ZSE 137</b>
2.0 TFSI	2.0	132	06.08–	CDNB/CAEA/CDZA	4	<b>ZSE 033</b> <sup>202</sup>
2.0 TFSI	2.0	132	06.08–	CDNB/CAEA/CDZA	4	<b>ZSE 142</b> <sup>202</sup>
2.0 TFSI	2.0	155	06.08–	CDNC/CADA	4	<b>ZSE 033</b> <sup>202</sup>
2.0 TFSI	2.0	155	06.08–	CDNC/CADA	4	<b>ZSE 142</b> <sup>202</sup>
2.0 TFSI flexible fuel	2.0	132	11.09–	CFKA	4	<b>ZSE 033</b> <sup>202</sup>
2.0 TFSI flexible fuel	2.0	132	11.09–	CFKA	4	<b>ZSE 142</b> <sup>202</sup>
2.0 TFSI flexible fuel quattro	2.0	132	11.09–	CFKA	4	<b>ZSE 033</b> <sup>202</sup>
2.0 TFSI flexible fuel quattro	2.0	132	11.09–	CFKA	4	<b>ZSE 142</b> <sup>202</sup>
2.0 TFSI quattro	2.0	155	06.08–	CDNC	4	<b>ZSE 033</b> <sup>202</sup>
2.0 TFSI quattro	2.0	155	06.08–	CDNC	4	<b>ZSE 142</b> <sup>202</sup>
3.2 FSI	3.2	195	09.08–	CALA	6	<b>ZSE 032</b>
3.2 FSI quattro	3.2	195	04.08–	CALA	6	<b>ZSE 032</b>
RS4 quattro	4.2	331	05.12–	CFSA	8	<b>ZSE 033</b>
S4 quattro	3.0	245	11.08–	CGWC/CAKA	6	<b>ZSE 032</b>

**A4 Cabriolet (8H7, B6, 8HE, B7)**

1.8 T	1.8	120	07.02–03.09	BFB	4	<b>ZSE 043</b>
1.8 T quattro	1.8	120	05.03–03.09	BFB	4	<b>ZSE 051</b>
2.0	2.0	96	09.04–12.05	ALT	4	<b>ZSE 051</b>
2.0	2.0	147	11.05–03.09	BWE	4	<b>ZSE 142</b> <sup>202</sup>
2.0 TFSI 16V	2.0	147	01.06–03.09	BWT/BWE	4	<b>ZSE 033</b> <sup>202</sup>
2.0 TFSI 16V	2.0	147	01.06–03.09	BWT/BWE	4	<b>ZSE 142</b> <sup>202</sup>
3.0	3.0	162	04.02–12.05	ASN	6	<b>ZSE 051</b>
3.0 quattro	3.0	162	05.03–12.05	ASN	6	<b>ZSE 051</b>
3.2 FSI	3.1	188	01.06–03.09	AUK	6	<b>ZSE 032</b>
3.2 FSI quattro	3.1	188	01.06–03.09	AUK	6	<b>ZSE 032</b>
RS4 quattro	4.2	309	06.06–01.08	BNS	8	<b>ZSE 142</b> <sup>202</sup>
S4 quattro	4.2	253	03.04–03.09	BBK	8	<b>ZSE 061</b>

**A5 (8T3)**

1.8 TFSI	1.8	118	05.09–	CDHB	4	<b>ZSE 033</b> <sup>202</sup>
1.8 TFSI	1.8	118	05.09–	CDHB	4	<b>ZSE 142</b> <sup>202</sup>
1.8 TFSI	1.8	125	10.07–	CABD	4	<b>ZSE 033</b>
1.8 TFSI	1.8	125	10.07–	CJEB	4	<b>ZSE 137</b> <sup>202</sup>
1.8 TFSI	1.8	125	10.07–	CABD/CJEB	4	<b>ZSE 142</b> <sup>202</sup>
2.0 TFSI	2.0	132	11.08–	CDNB	4	<b>ZSE 033</b> <sup>202</sup>
2.0 TFSI	2.0	132	11.08–	CDNB	4	<b>ZSE 142</b> <sup>202</sup>
2.0 TFSI	2.0	155	06.08–	CDNC	4	<b>ZSE 033</b> <sup>202</sup>



kW



AUDI							
<b>A5 (8T3)</b>							
2.0 TFSI	2.0	155	06.08–	CDNC	4		ZSE 142 <sup>202</sup>
2.0 TFSI quattro	2.0	155	06.08–	CAEB/CDNC	4		ZSE 033 <sup>202</sup>
2.0 TFSI quattro	2.0	155	06.08–	CAEB/CDNC	4		ZSE 142 <sup>202</sup>
3.2 FSI	3.2	195	06.07–	CALA	6		ZSE 032
3.2 FSI quattro	3.2	195	06.07–	CALA	6		ZSE 032
RS 5 quattro	4.2	331	03.10–	CFSA	8		ZSE 033
S5 quattro	3.0	245	10.11–	CGWC/CAKA/CGXC	6		ZSE 032
S5 quattro	4.2	260	06.07–	CAUA	8		ZSE 033
<b>A5 Cabriolet (8F7)</b>							
1.8 TFSI	1.8	118	09.09–	CDHB	4		ZSE 033 <sup>202</sup>
1.8 TFSI	1.8	118	09.09–	CDHB	4		ZSE 142 <sup>202</sup>
1.8 TFSI	1.8	125	10.11–	CABD	4		ZSE 033
1.8 TFSI	1.8	125	10.11–	CJEB	4		ZSE 137
2.0 TFSI	2.0	132	03.09–	CDNB/CAEA	4		ZSE 033 <sup>202</sup>
2.0 TFSI	2.0	132	03.09–	CDNB/CAEA	4		ZSE 142 <sup>202</sup>
2.0 TFSI	2.0	155	03.09–	CAEB/CDNC	4		ZSE 033 <sup>202</sup>
2.0 TFSI	2.0	155	03.09–	CAEB/CDNC	4		ZSE 142 <sup>202</sup>
2.0 TFSI quattro	2.0	155	03.09–	CAEB/CDNC	4		ZSE 033 <sup>202</sup>
2.0 TFSI quattro	2.0	155	03.09–	CAEB/CDNC	4		ZSE 142 <sup>202</sup>
3.2 FSI	3.2	195	03.09–	CALA	6		ZSE 032
3.2 FSI quattro	3.2	195	03.09–	CALA	6		ZSE 032
RS 5 quattro	4.2	331	02.13–	CFSA	8		ZSE 033
S5 quattro	3.0	245	06.09–	CGWC/CTUB/CAKA/CCBA/CGXC	6		ZSE 032
<b>A5 Sportback (8TA)</b>							
1.8 TFSI	1.8	118	11.09–	CDHB	4		ZSE 033 <sup>202</sup>
1.8 TFSI	1.8	118	11.09–	CDHB	4		ZSE 142 <sup>202</sup>
1.8 TFSI	1.8	125	08.11–	CJEB	4		ZSE 137
2.0 TFSI	2.0	132	09.09–	CDNB	4		ZSE 033 <sup>202</sup>
2.0 TFSI	2.0	132	09.09–	CDNB	4		ZSE 142 <sup>202</sup>
2.0 TFSI	2.0	155	09.09–	CDNC	4		ZSE 033 <sup>202</sup>
2.0 TFSI	2.0	155	09.09–	CDNC	4		ZSE 142 <sup>202</sup>
2.0 TFSI quattro	2.0	155	09.09–	CDNC	4		ZSE 033 <sup>202</sup>
2.0 TFSI quattro	2.0	155	09.09–	CDNC	4		ZSE 142 <sup>202</sup>
3.2 FSI quattro	3.2	195	09.09–	CALA	6		ZSE 032
S5 quattro	3.0	245	01.10–	CGWC/CAKA	6		ZSE 032
<b>A6 (4A, C4)</b>							
2.0	2.0	74	06.94–08.96	AAE	4		ZSE 036
2.0	2.0	85	06.94–10.97	ABK	4		ZSE 036
2.0 16V	2.0	103	06.94–10.97	ACE	4		ZSE 036
2.0 16V quattro	2.0	103	06.94–10.97	ACE	4		ZSE 036
2.3	2.3	98	06.94–12.95	AAR	5		ZSE 036
2.6	2.6	110	06.94–10.97	ABC	6	ZM 027	
2.6	2.6	110	06.94–10.97	ABC	6	ZM 063	
2.6	2.6	110	06.94–10.97	ABC	6		ZSE 007
2.6 quattro	2.6	110	06.94–10.97	ABC	6	ZM 027	ZSE 007
2.6 quattro	2.6	110	06.94–10.97	ABC	6	ZM 063	ZSE 007
2.8	2.8	128	06.94–10.97	AEJ/AAH/AFC	6	ZM 027	
2.8	2.8	128	06.94–10.97	AEJ/AAH/AFC	6	ZM 063	
2.8	2.8	128	06.94–10.97	AAH , AEJ	6		ZSE 007
2.8 quattro	2.8	128	06.94–10.97	AEJ/AAH	6	ZM 027	
2.8 quattro	2.8	128	06.94–10.97	AEJ/AAH	6	ZM 063	
2.8 quattro	2.8	128	06.94–10.97	AAH	6		ZSE 007
S6 Turbo quattro	2.2	169	06.94–10.97	AAN	5		ZS 043 ZLE 233
<b>A6 (4B, C5)</b>							
1.8	1.8	92	12.97–07.99	AJP	4		ZSE 009
1.8	1.8	92	01.99–04.01	AQE , ARH	4		ZSE 009
1.8 T	1.8	110	08.98–01.05	ARK/AEB/ANB/APU/AWT/AWL	4	ZM 028	
1.8 T	1.8	110	08.98–01.05	ARK/AEB/ANB/APU/AWT/AWL	4	ZM 062	
1.8 T	1.8	110	01.97–01.05	AEB, ANB, APU, ARK	4		ZS 016 ZLE 276
1.8 T	1.8	110	06.00–01.05	AWT	4		ZSE 043
1.8 T	1.8	132	08.98–01.05	AJL	4	ZM 028	



kW



## AUDI

AUDI								
<b>A6 (4B, C5)</b>								
1.8 T	1.8	132	08.98-01.05	AJL	4	ZM 062		
1.8 T	1.8	132	12.97-01.05	AJL	4		ZS 016	ZLE 276
1.8 T quattro	1.8	110	08.98-01.05	ARK/AEB/ANB/APU/AWT	4	ZM 028		
1.8 T quattro	1.8	110	08.98-01.05	ARK/AEB/ANB/APU/AWT	4	ZM 062		
1.8 T quattro	1.8	110	02.97-01.05	AEB, ANB, APU, ARK	4		ZS 016	ZLE 276
1.8 T quattro	1.8	110	06.00-01.05	AWT	4		ZSE 043	
1.8 T quattro	1.8	132	08.98-01.05	AJL	4	ZM 028		
1.8 T quattro	1.8	132	08.98-01.05	AJL	4	ZM 062		
1.8 T quattro	1.8	132	12.97-01.05	AJL	4		ZS 016	ZLE 276
2.0	2.0	96	08.01-01.05	ALT	4		ZSE 043	
2.7 T	2.7	169	02.99-01.05	AJK	6		ZS 016	ZLE 276
2.7 T quattro	2.7	169	12.97-01.05	AJK	6		ZS 016	ZLE 276
2.7 T quattro	2.7	184	08.01-01.05	ARE	6		ZS 016	ZLE 276
2.7 T quattro	2.7	184	08.01-01.05	BES	6		ZSE 043	
3.0	3.0	162	08.01-01.05	ASN	6		ZSE 051	
3.0 quattro	3.0	162	08.01-01.05	ASN	6		ZSE 051	
3.7	3.7	191	03.99-01.05	AQG	8		ZSE 009	
3.7 quattro	3.7	191	03.99-01.05	AQG	8		ZSE 009	
4.2 quattro	4.2	220	06.00-05.01	ASG	8		ZSE 009	
4.2 quattro	4.2	220	04.99-05.01	ARS	8		ZSE 009	
S6 quattro	4.2	250	09.00-05.01	ANK , AQJ	8		ZSE 009	
<b>A6 (4F2, C6)</b>								
2.0 TFSI	2.0	125	06.05-03.11	BPJ/BYK	4		ZSE 033	
2.4	2.4	130	05.04-10.08	BDW	6		ZSE 032	
2.4 quattro	2.4	130	01.05-10.08	BDW	6		ZSE 032	
3.2 FSI	3.1	188	05.04-05.09	AUK/BKH	6		ZSE 032	
3.2 FSI	3.2	195	05.09-03.11	CALA	6		ZSE 032	
3.2 FSI quattro	3.1	188	05.04-10.08	AUK/BKH	6		ZSE 032	
4.2 quattro	4.2	246	05.04-05.06	BAT	8		ZSE 061	
<b>A6 (4G2, C7)</b>								
2.0 TFSI	2.0	132	05.11-	CDNB	4		ZSE 033 <sup>202</sup>	
2.0 TFSI	2.0	132	05.11-	CDNB	4		ZSE 142 <sup>202</sup>	
2.0 TFSI	2.0	155	03.11-	CAEB	4		ZSE 033 <sup>202</sup>	
2.0 TFSI	2.0	155	03.11-	CAEB	4		ZSE 142 <sup>202</sup>	
2.0 TFSI hybrid	2.0	155	11.11-	CHJA	4		ZSE 033 <sup>202</sup>	
2.0 TFSI hybrid	2.0	155	11.11-	CHJA	4		ZSE 142 <sup>202</sup>	
2.8 FSI	2.8	150	03.11-	CHVA	6		ZSE 032	
2.8 FSI quattro	2.8	150	03.11-	CHVA	6		ZSE 032	
3.0 TFSI quattro	3.0	220	11.10-	CGWB	6		ZSE 032	
3.0 TFSI quattro	3.0	228	03.11-	CGXB , CTUA , CGWD	6		ZSE 032	
<b>A6 Allroad (4FH, C6)</b>								
3.2 FSI quattro	3.1	188	05.06-10.08	AUK	6		ZSE 032	
<b>A6 Avant (4A, C4)</b>								
2.0	2.0	85	06.94-12.97	ABK	4		ZSE 036	
2.0 16V	2.0	103	06.94-12.97	ACE	4		ZSE 036	
2.0 16V quattro	2.0	103	06.94-12.97	ACE	4		ZSE 036	
2.6	2.6	110	06.94-12.97	ABC	6	ZM 027	ZSE 007	
2.6	2.6	110	06.94-12.97	ABC	6	ZM 063	ZSE 007	
2.6 quattro	2.6	110	06.94-12.97	ABC	6	ZM 027	ZSE 007	
2.6 quattro	2.6	110	06.94-12.97	ABC	6	ZM 063	ZSE 007	
2.8	2.8	128	06.94-12.97	AEJ/AAH	6	ZM 027	ZSE 007	
2.8	2.8	128	06.94-12.97	AEJ/AAH	6	ZM 063	ZSE 007	
2.8 quattro	2.8	128	06.94-12.97	AEJ/AAH	6	ZM 027	ZSE 007	
2.8 quattro	2.8	128	06.94-12.97	AEJ/AAH	6	ZM 063	ZSE 007	
S6 Turbo quattro	2.2	169	06.94-12.97	AAN	5		ZS 043	ZLE 233
<b>A6 Avant (4B, C5)</b>								
1.8	1.8	92	01.99-07.99	AJP	4		ZSE 009	
1.8	1.8	92	01.99-04.01	AQE , ARH	4		ZSE 009	
1.8 T	1.8	110	08.98-01.05	ARK/AEB/ANB/APU/AWT	4	ZM 028		
1.8 T	1.8	110	08.98-01.05	ARK/AEB/ANB/APU/AWT	4	ZM 062		
1.8 T	1.8	110	12.97-01.05	AEB, ANB, APU, ARK	4		ZS 016	ZLE 276



kW



AUDI									
<b>A6 Avant (4B, C5)</b>									
1.8 T	1.8	110	06.00-01.05	AWT	4			<b>ZSE 043</b>	
1.8 T	1.8	132	04.99-01.05	AJL	4	<b>ZM 028</b>		<b>ZS 016</b>	
1.8 T	1.8	132	04.99-01.05	AJL	4	<b>ZM 062</b>		<b>ZS 016</b>	
1.8 T quattro	1.8	110	08.98-01.05	ARK/AEB/ANB/APU/AWT	4	<b>ZM 028</b>			
1.8 T quattro	1.8	110	08.98-01.05	ARK/AEB/ANB/APU/AWT	4	<b>ZM 062</b>			
1.8 T quattro	1.8	110	12.97-01.05	AEB, ANB, APU, ARK	4			<b>ZS 016</b>	<b>ZLE 276</b>
1.8 T quattro	1.8	110	06.00-01.05	AWT	4			<b>ZSE 043</b>	
1.8 T quattro	1.8	132	08.98-01.05	AJL	4	<b>ZM 028</b>			
1.8 T quattro	1.8	132	08.98-01.05	AJL	4	<b>ZM 062</b>			
1.8 T quattro	1.8	132	12.97-01.05	AJL	4			<b>ZS 016</b>	<b>ZLE 276</b>
2.0	2.0	96	08.01-01.05	ALT	4			<b>ZSE 043</b>	
2.7 T quattro	2.7	184	08.01-01.05	ARE	6			<b>ZS 016</b>	<b>ZLE 276</b>
3.0 quattro	3.0	162	08.01-01.05	ASN	6			<b>ZSE 051</b>	
4.2 quattro	4.2	220	06.00-05.01	ASG	8			<b>ZSE 009</b>	
4.2 quattro	4.2	220	04.99-05.01	ARS	8			<b>ZSE 009</b>	
S6 quattro	4.2	250	09.00-05.01	ANK , AQJ	8			<b>ZSE 009</b>	
<b>A6 Avant (4F5, C6)</b>									
2.0 TFSI	2.0	125	06.05-08.11	BPJ	4			<b>ZSE 033</b>	
2.4	2.4	130	03.05-10.08	BDW	6			<b>ZSE 032</b> <sup>202</sup>	
2.4	2.4	130	03.05-10.08	BDW	6			<b>ZSE 142</b> <sup>202</sup>	
2.4 quattro	2.4	130	03.05-10.08	BDW	6			<b>ZSE 032</b> <sup>202</sup>	
2.4 quattro	2.4	130	03.05-10.08	BDW	6			<b>ZSE 142</b> <sup>202</sup>	
2.8 FSI	2.8	162	10.08-08.11	CCEA	6			<b>ZSE 032</b>	
3.2 FSI	3.1	188	03.05-10.08	AUK	6			<b>ZSE 032</b>	
3.2 FSI quattro	3.1	188	03.05-10.08	AUK	6			<b>ZSE 032</b>	
4.2 quattro	4.2	246	03.05-05.06	BAT	8			<b>ZSE 061</b>	
<b>A6 Avant (4G5, C7)</b>									
2.0 TFSI	2.0	132	06.11-	CDNB	4			<b>ZSE 033</b> <sup>202</sup>	
2.0 TFSI	2.0	132	06.11-	CDNB	4			<b>ZSE 142</b> <sup>202</sup>	
2.8 FSI	2.8	150	05.11-	CHVA	6			<b>ZSE 032</b>	
2.8 FSI quattro	2.8	150	05.11-	CHVA	6			<b>ZSE 032</b>	
3.0 TFSI quattro	3.0	220	05.11-	CGWB	6			<b>ZSE 032</b>	
3.0 TFSI quattro	3.0	228	11.11-	CGWD	6			<b>ZSE 032</b>	
<b>A7 Sportback (4GA)</b>									
2.8 FSI	2.8	150	02.11-	CHVA	6			<b>ZSE 032</b>	
3.0 TFSI quattro	3.0	228	01.11-	CGXB , CTTA , CTUA , CGWD	6			<b>ZSE 032</b>	
<b>A8 (4D2, 4D8)</b>									
2.8	2.8	120	07.95-03.96	AEJ	6			<b>ZSE 008</b>	
2.8	2.8	128	03.94-03.96	AAH	6			<b>ZSE 008</b>	
2.8 quattro	2.8	120	07.95-03.96	AEJ	6			<b>ZSE 008</b>	
2.8 quattro	2.8	128	03.94-03.96	AAH	6			<b>ZSE 008</b>	
3.7	3.7	169	07.95-12.98	AEW, AKJ	8	<b>ZM 027</b> <sup>202</sup>			
3.7	3.7	169	07.95-12.98	AEW, AKJ	8	<b>ZM 063</b> <sup>202</sup>			
3.7	3.7	169	07.95-12.98	AEW Fgst.Nr.→4D-T-000220	8			<b>ZS 012</b> <sup>202</sup>	
3.7	3.7	169	07.95-12.98	AEW	8			<b>ZS 016</b> <sup>202</sup>	<b>ZLE 276</b>
3.7	3.7	169	07.95-12.98	AEW	8			<b>ZS 017</b> <sup>202</sup>	<b>ZLE 277</b>
3.7 quattro	3.7	169	07.95-11.98	AEW, AKJ	8	<b>ZM 027</b> <sup>202</sup>			
3.7 quattro	3.7	169	07.95-11.98	AEW, AKJ	8	<b>ZM 063</b> <sup>202</sup>			
3.7 quattro	3.7	169	07.95-11.98	AKJ/AEW Fgst.Nr.→4D-T-000220	8			<b>ZS 012</b> <sup>202</sup>	
3.7 quattro	3.7	169	07.95-11.98	AKJ/AEW	8			<b>ZS 016</b> <sup>202</sup>	<b>ZLE 276</b>
3.7 quattro	3.7	169	07.95-11.98	AKJ/AEW	8			<b>ZS 017</b> <sup>202</sup>	<b>ZLE 277</b>
4.2 quattro	4.2	175	02.99-04.00	ARU	8			<b>ZSE 009</b>	
4.2 quattro	4.2	180	03.94-07.96	AEM Fgst.Nr.→4D-T-000220	8	<b>ZM 062</b>		<b>ZS 012</b>	
4.2 quattro	4.2	180	03.94-07.96	AEM Fgst.Nr.4D-T-000 221→	8	<b>ZM 062</b>		<b>ZS 016</b>	<b>ZLE 276</b>
4.2 quattro	4.2	220	03.94-11.98	ABZ, AKG	8	<b>ZM 027</b> <sup>202</sup>			
4.2 quattro	4.2	220	03.94-11.98	ABZ, AKG	8	<b>ZM 063</b> <sup>202</sup>			
4.2 quattro	4.2	220	03.94-11.98	AKG/ABZ Fgst.Nr.→4D-T-000220	8			<b>ZS 012</b> <sup>202</sup>	





kW

**AUDI****A8 (4D2, 4D8)**

4.2 quattro	4.2	220	03.94–11.98	AKG/ABZ Fgst.Nr.4D-T-000 221→	8		<b>ZS 016<sup>202</sup></b>	<b>ZLE 276</b>
4.2 quattro	4.2	220	03.94–11.98	AKG/ABZ Fgst.Nr.4D-T-000 221→	8		<b>ZS 017<sup>202</sup></b>	<b>ZLE 277</b>
4.2 quattro	4.2	228	11.98–02.01	AQF	8		<b>ZSE 009</b>	
S 8 quattro	4.2	250	07.96–06.99	AHC/AKH	8	<b>ZM 027</b>		
S 8 quattro	4.2	250	07.96–06.99	AHC/AKH	8	<b>ZM 063</b>		
S 8 quattro	4.2	250	07.96–06.99	AHC/AKH Fgst.Nr.→4D-T-000220	8		<b>ZS 012</b>	
S 8 quattro	4.2	250	07.96–06.99	AHC/AKH Fgst.Nr.4D-T-000 221→	8		<b>ZS 016</b>	<b>ZLE 276</b>
S 8 quattro	4.2	265	09.00–02.01	AQH , AVP	8		<b>ZSE 009</b>	

**A8 (4E\_)**

3.0	3.0	160	07.03–05.06	BBJ	6		<b>ZSE 051</b>	
3.0	3.0	162	07.03–05.05	ASN	6		<b>ZSE 051</b>	
3.7 quattro	3.7	206	10.02–05.06	BFL	8		<b>ZSE 061</b>	
4.2 quattro	4.2	246	10.02–07.10	BFM	8		<b>ZSE 061</b>	
6.0 W12 quattro	6.0	331	12.03–07.10	BTE/BSB/BHT	12		<b>ZSE 031</b>	

**A8 (4H\_)**

2.0 TFSI hybrid	2.0	155	02.12–	CHJA	4		<b>ZSE 033</b>	
3.0 TFSI quattro	3.0	213	07.10–	CGWA	6		<b>ZSE 032</b>	
3.0 TFSI quattro	3.0	228	11.11–	CGWD	6		<b>ZSE 032</b>	
3.0 TFSI quattro	3.0	245	06.10–	CMDA , CGXC , CTUB	6		<b>ZSE 032</b>	
4.2 FSI quattro	4.2	273	11.09–	CDRA	8		<b>ZSE 032</b>	
6.3 W12 quattro	6.3	368	01.11–	CEJA	12		<b>ZSE 138</b>	

**ALLROAD (4BH, C5)**

2.7 T quattro	2.7	184	05.00–08.05	ARE	6		<b>ZS 016</b>	<b>ZLE 276</b>
4.2 V8 quattro	4.2	220	07.02–08.05	BAS	8		<b>ZSE 062</b>	

**CABRIOLET (8G7, B4)**

1.8	1.8	92	01.97–08.00	ADR	4	<b>ZM 063</b>		
2.0 E	2.0	85	01.93–07.93	ABK	4		<b>ZSE 001</b>	
2.0 E	2.0	85	07.93–07.98	ABK	4		<b>ZSE 005</b>	
2.3 E	2.3	98	05.91–07.94	NG	5		<b>ZSE 005</b>	
2.6	2.6	110	06.93–08.00	ABC	6	<b>ZM 027</b>	<b>ZSE 007</b>	
2.6	2.6	110	06.93–08.00	ABC	6	<b>ZM 063</b>	<b>ZSE 007</b>	
2.8	2.8	128	11.92–08.00	AAH	6	<b>ZM 027</b>	<b>ZSE 007</b>	
2.8	2.8	128	11.92–08.00	AAH	6	<b>ZM 063</b>	<b>ZSE 007</b>	

**COUPE (81, 85)**

1.8 GT	1.8	65	04.86–09.86	SF	4	<b>ZM 002</b>		
1.8 GT	1.8	65	10.86–10.88	SF	4	<b>ZM 012</b>		
1.8 GT	1.8	66	09.82–10.88	DS/JV	4	<b>ZM 012</b>		
1.8 GT	1.8	68	10.86–07.88	JN	4	<b>ZM 012</b>		
1.8 GT	1.8	68	01.85–09.86	JN	4	<b>ZM 002</b>		
1.8 GT	1.8	79	08.86–09.86	PV	4	<b>ZM 002</b>		
1.8 GT	1.8	79	10.86–10.87	PV	4	<b>ZM 012</b>		
1.8 GT	1.8	82	08.86–09.86	DZ	4	<b>ZM 002</b>		
1.8 GT	1.8	82	10.86–10.88	DZ	4	<b>ZM 012</b>		
2.0	2.0	83	10.86–04.88	SK	5	<b>ZM 012</b>		
2.0	2.0	83	03.86–09.86	SK	5	<b>ZM 002</b>		
2.0	2.0	85	09.83–07.86	JS/HP	5	<b>ZM 002</b>		
2.1 GT	2.1	96	09.82–08.84	KE/KL	5	<b>ZM 002</b>		
2.2 GT	2.2	85	01.84–09.86	KX	5	<b>ZM 002</b>		
2.2 GT	2.2	85	10.86–10.87	KX	5	<b>ZM 012</b>		
2.2 GT	2.2	100	09.84–07.85	KV/HY	5		<b>ZS 124</b>	
2.2 GT	2.2	100	09.84–09.86	KV/HY	5	<b>ZM 002</b>		
2.2 GT	2.2	100	10.86–10.88	KV/HY	5	<b>ZM 012</b>		
2.2 quattro	2.2	88	08.85–09.86	JT	5	<b>ZM 002</b>		
2.2 quattro	2.2	88	10.86–10.88	JT	5	<b>ZM 012</b>		
2.2 quattro	2.2	88	08.85–10.88	JT	5		<b>ZS 124</b>	
2.2 quattro	2.2	100	10.84–07.85	KV	5		<b>ZS 124</b>	
2.2 quattro	2.2	100	10.84–09.86	KV	5	<b>ZM 002</b>		
2.2 quattro	2.2	100	10.86–10.88	KV	5	<b>ZM 012</b>		

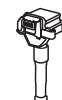

kW

**AUDI****COUPE (81, 85)**

2.3	2.3	100	01.87–10.88	NG	5		<b>ZSE 005</b>	
2.3 quattro	2.3	100	01.87–10.88	NG	5		<b>ZSE 005</b>	

**COUPE (89, 88)**

1.8	1.8	82	08.89–07.91	DZ	4	<b>ZM 012</b>		
2.0	2.0	85	09.91–07.93	ABK Fgst.Nr.→8B..P..015000	4		<b>ZSE 001</b>	
2.0	2.0	85	07.93–12.95	ABK Fgst.Nr.8B..R..000001→	4		<b>ZSE 005</b>	
2.0	2.0	85	05.89–12.96	ABK/AAD	4	<b>ZM 012</b> <sup>283</sup>		
2.0 16 V	2.0	103	08.92–12.95	ACE	4	<b>ZM 031</b>		
2.0 20 V	2.0	118	08.89–07.91	NM	5		<b>ZSE 005</b>	
2.0 20 V quattro	2.0	118	08.89–07.91	NM	5		<b>ZSE 005</b>	
2.2 quattro	2.2	100	11.88–07.91	KV	5	<b>ZM 012</b>		
2.3	2.3	98	03.90–12.96	NG	5		<b>ZSE 005</b>	
2.3	2.3	100	10.88–07.94	NG Fgst.Nr.→88-M-040000	5	<b>ZM 030</b>		
2.3	2.3	100	10.88–07.94	NG	5		<b>ZSE 005</b>	
2.3 20V	2.3	123	08.90–07.91	7A	5		<b>ZSE 005</b>	
2.3 20V	2.3	125	08.89–07.91	7A	5		<b>ZSE 005</b>	
2.3 20V quattro	2.3	123	05.90–07.91	7A	5		<b>ZSE 005</b>	
2.3 20V quattro	2.3	125	11.88–07.91	7A	5		<b>ZSE 005</b>	
2.3 quattro	2.3	98	05.90–06.94	NG	5	<b>ZM 030</b>	<b>ZSE 005</b>	
2.3 quattro	2.3	100	11.88–12.92	NG	5	<b>ZM 030</b>	<b>ZSE 005</b>	
2.6	2.6	110	08.92–12.96	ABC	6	<b>ZM 027</b>	<b>ZSE 007</b>	
2.6	2.6	110	08.92–12.96	ABC	6	<b>ZM 063</b>	<b>ZSE 007</b>	
2.6 quattro	2.6	110	08.92–12.96	ABC	6	<b>ZM 027</b>	<b>ZSE 007</b>	
2.6 quattro	2.6	110	08.92–12.96	ABC	6	<b>ZM 063</b>	<b>ZSE 007</b>	
2.8	2.8	128	09.91–12.96	AAH	6	<b>ZM 027</b>	<b>ZSE 007</b>	
2.8	2.8	128	09.91–12.96	AAH	6	<b>ZM 063</b>	<b>ZSE 007</b>	
2.8 quattro	2.8	128	08.91–12.96	AAH	6	<b>ZM 027</b>	<b>ZSE 007</b>	
2.8 quattro	2.8	128	08.91–12.96	AAH	6	<b>ZM 063</b>	<b>ZSE 007</b>	
S2 quattro	2.2	162	09.90–09.92	3B	5	<b>ZM 012</b>	<b>ZSE 005</b>	
S2 quattro	2.2	169	10.92–12.96	ABY	5	<b>ZM 063</b>	<b>ZS 043</b>	<b>ZLE 233</b>
<b>Q3</b>								
2.0 TFSI quattro	2.0	125	06.11–	CCZC	4		<b>ZSE 033</b> <sup>202</sup>	
2.0 TFSI quattro	2.0	125	06.11–	CCZC	4		<b>ZSE 142</b> <sup>202</sup>	
2.0 TFSI quattro	2.0	155	06.11–	CPSA	4		<b>ZSE 033</b> <sup>202</sup>	
2.0 TFSI quattro	2.0	155	06.11–	CPSA	4		<b>ZSE 142</b> <sup>202</sup>	
<b>Q5 (8R)</b>								
2.0 TFSI hybrid quattro	2.0	155	06.11–	CHJA	4		<b>ZSE 033</b> <sup>202</sup>	
2.0 TFSI hybrid quattro	2.0	155	06.11–	CHJA	4		<b>ZSE 142</b> <sup>202</sup>	
2.0 TFSI quattro	2.0	132	08.09–	CDNB/CNCB	4		<b>ZSE 033</b> <sup>202</sup>	
2.0 TFSI quattro	2.0	132	08.09–	CDNB/CNCB	4		<b>ZSE 142</b> <sup>202</sup>	
2.0 TFSI quattro	2.0	155	11.08–	CAEB/CPMA/CDNC	4		<b>ZSE 033</b> <sup>202</sup>	
2.0 TFSI quattro	2.0	155	11.08–	CAEB/CPMA/CDNC	4		<b>ZSE 142</b> <sup>202</sup>	
2.0 TFSI quattro	2.0	162	05.13–	CPMB	4		<b>ZSE 033</b>	
2.0 TFSI quattro	2.0	165	06.12–	CNCD	4		<b>ZSE 033</b>	
3.2 FSI quattro	3.2	199	11.08–	CALB	6		<b>ZSE 033</b>	
<b>Q7 (4L)</b>								
3.0 TFSI	3.0	200	05.10–	CJWC/CJTC	6		<b>ZSE 032</b>	
3.0 TFSI	3.0	206	05.11–	CJWE , CTWB	6		<b>ZSE 032</b>	
3.0 TFSI	3.0	245	05.10–	CJTB/CTWA/CNAA/CJWB	6		<b>ZSE 032</b>	
3.6 FSI	3.6	206	08.06–05.10	BHK	6		<b>ZSE 041</b>	
4.2 FSI	4.2	257	03.06–05.10	BAR	8		<b>ZSE 032</b>	
<b>QUATTRO</b>								
2.1 Turbo	2.1	147	07.80–07.87	WR/GV	5	<b>ZM 002</b>	<b>ZS 120</b>	
2.2 20V	2.2	162	08.89–07.91	RR	5	<b>ZM 030</b>	<b>ZSE 036</b>	
2.2 Turbo	2.2	147	08.87–07.89	MB	5		<b>ZSE 036</b>	
<b>R8</b>								
4.2 FSI quattro	4.2	309	04.07–09.10	BYH	8		<b>ZSE 032</b>	
4.2 FSI quattro	4.2	316	07.10–	CNDA	8		<b>ZSE 032</b>	
5.2 FSI quattro	5.2	386	04.09–05.12	BUJ/CTYA	10		<b>ZSE 032</b>	



kW

**AUDI****R8**

5.2 FSI quattro	5.2	412	11.10-	CMPA	10		<b>ZSE 033</b>
-----------------	-----	-----	--------	------	----	--	----------------

**R8 Spyder**

4.2 FSI quattro	4.2	316	09.10-	CNDA	8		<b>ZSE 032</b>
-----------------	-----	-----	--------	------	---	--	----------------

5.2 FSI quattro	5.2	412	11.11-	CMPA	10		<b>ZSE 033</b>
-----------------	-----	-----	--------	------	----	--	----------------

**TT (8J3)**

1.8 TFSI	1.8	118	06.08-	CDAA	4		<b>ZSE 033</b>
----------	-----	-----	--------	------	---	--	----------------

1.8 TFSI	1.8	118	06.08-	CDAA	4		<b>ZSE 142</b> <sup>202</sup>
----------	-----	-----	--------	------	---	--	-------------------------------

2.0 quattro	2.0	195	05.08-	CDLA , CDMA	4		<b>ZSE 033</b> <sup>202</sup>
-------------	-----	-----	--------	-------------	---	--	-------------------------------

2.0 quattro	2.0	195	05.08-	CDMA/CDLA	4		<b>ZSE 142</b> <sup>202</sup>
-------------	-----	-----	--------	-----------	---	--	-------------------------------

2.0 TFSI	2.0	147	08.06-06.10	BWA/BPY/CCTA	4		<b>ZSE 033</b> <sup>202</sup>
----------	-----	-----	-------------	--------------	---	--	-------------------------------

2.0 TFSI	2.0	147	08.06-06.10	BWA/BPY/CCTA	4		<b>ZSE 142</b> <sup>202</sup>
----------	-----	-----	-------------	--------------	---	--	-------------------------------

2.0 TFSI	2.0	155	05.10-	CESA	4		<b>ZSE 033</b> <sup>202</sup>
----------	-----	-----	--------	------	---	--	-------------------------------

2.0 TFSI	2.0	155	05.10-	CESA	4		<b>ZSE 142</b> <sup>202</sup>
----------	-----	-----	--------	------	---	--	-------------------------------

2.0 TFSI quattro	2.0	147	06.08-06.10	CCZA	4		<b>ZSE 033</b> <sup>202</sup>
------------------	-----	-----	-------------	------	---	--	-------------------------------

2.0 TFSI quattro	2.0	147	06.08-06.10	CCZA	4		<b>ZSE 142</b> <sup>202</sup>
------------------	-----	-----	-------------	------	---	--	-------------------------------

2.0 TFSI quattro	2.0	155	05.10-	CETA/CESA	4		<b>ZSE 033</b> <sup>202</sup>
------------------	-----	-----	--------	-----------	---	--	-------------------------------

2.0 TFSI quattro	2.0	155	05.10-	CETA/CESA	4		<b>ZSE 142</b> <sup>202</sup>
------------------	-----	-----	--------	-----------	---	--	-------------------------------

2.0 TFSI quattro	2.0	200	05.08-	CDLB	4		<b>ZSE 033</b> <sup>202</sup>
------------------	-----	-----	--------	------	---	--	-------------------------------

2.0 TFSI quattro	2.0	200	05.08-	CDLB	4		<b>ZSE 142</b> <sup>202</sup>
------------------	-----	-----	--------	------	---	--	-------------------------------

2.5 TFSI quattro	2.5	250	07.09-	CEPA	5		<b>ZSE 033</b>
------------------	-----	-----	--------	------	---	--	----------------

2.5 TFSI quattro	2.5	265	05.11-	CEPB	5		<b>ZSE 033</b>
------------------	-----	-----	--------	------	---	--	----------------

3.2 V6 quattro	3.2	184	08.06-06.10	BUB	6		<b>ZSE 041</b>
----------------	-----	-----	-------------	-----	---	--	----------------

3.2 V6 quattro	3.2	184	08.06-06.10	BUB	6		<b>ZSE 044</b>
----------------	-----	-----	-------------	-----	---	--	----------------

**TT (8N3)**

1.8 T	1.8	110	09.02-06.06	AUM Fgst.Nr.→8N-1-010 000	4		<b>ZSE 009</b>
-------	-----	-----	-------------	------------------------------	---	--	----------------

1.8 T	1.8	110	01.03-06.06	AUM Fgst.Nr.8N-1-010 001→	4		<b>ZSE 043</b>
-------	-----	-----	-------------	------------------------------	---	--	----------------

1.8 T	1.8	132	10.98-06.06	AJQ , APP	4		<b>ZSE 009</b>
-------	-----	-----	-------------	-----------	---	--	----------------

1.8 T	1.8	132	01.03-06.06	ARY , AUQ	4		<b>ZSE 043</b>
-------	-----	-----	-------------	-----------	---	--	----------------

1.8 T quattro	1.8	132	10.98-06.06	AJQ	4		<b>ZSE 009</b>
---------------	-----	-----	-------------	-----	---	--	----------------

1.8 T quattro	1.8	132	01.03-06.06	ARY	4		<b>ZSE 043</b>
---------------	-----	-----	-------------	-----	---	--	----------------

1.8 T quattro	1.8	165	01.03-06.06	BAM Fgst.Nr.8N-1-010 001→	4		<b>ZSE 043</b>
---------------	-----	-----	-------------	------------------------------	---	--	----------------

1.8 T quattro	1.8	165	09.00-08.01	APX , BAM	4		<b>ZSE 009</b>
---------------	-----	-----	-------------	-----------	---	--	----------------

3.2 VR6 quattro	3.2	184	07.03-06.06	BPF/BHE	6		<b>ZSE 044</b>
-----------------	-----	-----	-------------	---------	---	--	----------------

**TT Roadster (8J9)**

1.8 TFSI	1.8	118	06.08-	CDAA	4		<b>ZSE 033</b> <sup>202</sup>
----------	-----	-----	--------	------	---	--	-------------------------------

1.8 TFSI	1.8	118	06.08-	CDAA	4		<b>ZSE 142</b> <sup>202</sup>
----------	-----	-----	--------	------	---	--	-------------------------------

2.0 quattro	2.0	195	05.08-	CDMA/CDLA	4		<b>ZSE 033</b> <sup>202</sup>
-------------	-----	-----	--------	-----------	---	--	-------------------------------

2.0 quattro	2.0	195	05.08-	CDMA/CDLA	4		<b>ZSE 142</b> <sup>202</sup>
-------------	-----	-----	--------	-----------	---	--	-------------------------------

2.0 TFSI	2.0	147	03.07-06.10	BWA/BPY/CCTA	4		<b>ZSE 033</b> <sup>202</sup>
----------	-----	-----	-------------	--------------	---	--	-------------------------------

2.0 TFSI	2.0	147	03.07-06.10	BWA/BPY/CCTA	4		<b>ZSE 142</b> <sup>202</sup>
----------	-----	-----	-------------	--------------	---	--	-------------------------------

2.0 TFSI	2.0	155	05.10-	CESA	4		<b>ZSE 033</b> <sup>202</sup>
----------	-----	-----	--------	------	---	--	-------------------------------

2.0 TFSI	2.0	155	05.10-	CESA	4		<b>ZSE 142</b> <sup>202</sup>
----------	-----	-----	--------	------	---	--	-------------------------------

2.0 TFSI quattro	2.0	147	06.08-06.10	CCZA	4		<b>ZSE 033</b> <sup>202</sup>
------------------	-----	-----	-------------	------	---	--	-------------------------------

2.0 TFSI quattro	2.0	147	06.08-06.10	CCZA	4		<b>ZSE 142</b> <sup>202</sup>
------------------	-----	-----	-------------	------	---	--	-------------------------------

2.0 TFSI quattro	2.0	155	05.10-	CETA/CESA	4		<b>ZSE 033</b> <sup>202</sup>
------------------	-----	-----	--------	-----------	---	--	-------------------------------

2.0 TFSI quattro	2.0	155	05.10-	CETA/CESA	4		<b>ZSE 142</b> <sup>202</sup>
------------------	-----	-----	--------	-----------	---	--	-------------------------------

2.0 TFSI quattro	2.0	200	05.08-	CDLB	4		<b>ZSE 033</b> <sup>202</sup>
------------------	-----	-----	--------	------	---	--	-------------------------------

2.0 TFSI quattro	2.0	200	05.08-	CDLB	4		<b>ZSE 142</b> <sup>202</sup>
------------------	-----	-----	--------	------	---	--	-------------------------------

2.5 TFSI quattro	2.5	250	07.09-	CEPA	5		<b>ZSE 033</b>
------------------	-----	-----	--------	------	---	--	----------------

2.5 TFSI quattro	2.5	265	03.12-	CEPB	5		<b>ZSE 033</b>
------------------	-----	-----	--------	------	---	--	----------------

**TT Roadster (8N9)**

1.8 T	1.8	110	01.03-06.06	AUM	4		<b>ZSE 043</b>
-------	-----	-----	-------------	-----	---	--	----------------

1.8 T	1.8	132	01.03-06.06	AUQ	4		<b>ZSE 043</b>
-------	-----	-----	-------------	-----	---	--	----------------

1.8 T	1.8	132	09.00-09.00	APP , AUQ	4		<b>ZSE 009</b>
-------	-----	-----	-------------	-----------	---	--	----------------

1.8 T quattro	1.8	132	02.00-06.06	AJQ	4		<b>ZS 016</b> <b>ZLE 276</b>
---------------	-----	-----	-------------	-----	---	--	------------------------------

1.8 T quattro	1.8	132	01.03-06.06	ARY	4		<b>ZSE 043</b>
---------------	-----	-----	-------------	-----	---	--	----------------

1.8 T quattro	1.8	165	01.03-06.06	BAM	4		<b>ZSE 043</b>
---------------	-----	-----	-------------	-----	---	--	----------------

**V8 (44 , 4C )**

3.6 quattro	3.6	180	04.93-02.94	PT	8		<b>ZSE 036</b>
-------------	-----	-----	-------------	----	---	--	----------------



kW

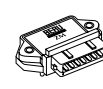

## AUDI

## V8 (44 , 4C )

3.6 quattro	3.6	184	10.88-02.94	PT	8		ZSE 036	
4.2 quattro	4.2	206	10.91-02.94	ABH	8		ZSE 036	
<b>80 (81, 85, B2)</b>								
1.3	1.3	44	09.78-07.84	EP	4		ZS 106	
1.3	1.3	44	08.84-07.85	EP	4		ZS 124	
1.3	1.3	44	08.81-07.86	EP	4	ZM 002		
1.6	1.6	54	02.86-07.86	SA	4	ZM 002		
1.6	1.6	55	06.84-07.85	DT	4		ZS 124	
1.6	1.6	55	08.83-07.86	DT	4	ZM 002		
1.6 GLE	1.6	81	08.80-12.86	YZ	4	ZM 002		
1.6 GLE	1.6	81	01.79-12.86	780	4		ZS 106	
1.8	1.8	65	02.86-07.86	SF	4	ZM 002		
1.8	1.8	66	06.84-07.85	DS	4		ZS 124	
1.8	1.8	66	01.83-08.86	DS	4	ZM 002		
1.8	1.8	68	08.83-07.85	JN	4	ZM 002	ZS 124	
1.8 CC quattro	1.8	66	08.84-07.85	NE/JV	4	ZM 002	ZS 124	
1.8 CC quattro	1.8	68	08.85-08.86	JN	4	ZM 002		
1.8 GTE	1.8	81	08.85-07.86	PV	4	ZM 002		
1.8 GTE	1.8	82	10.84-07.85	DZ	4	ZM 002	ZS 124	
1.8 GTE quattro	1.8	81	03.85-07.85	PV	4	ZM 002	ZS 124	
1.8 GTE quattro	1.8	82	08.84-07.85	DZ	4	ZM 002	ZS 124	
2.0 quattro	2.0	85	10.83-09.84	JS	5	ZM 002		
2.2 quattro	2.1	96	08.82-07.84	KL	5	ZM 002		
2.2 quattro	2.1	100	08.82-07.84	KK	5	ZM 002		
<b>80 (89, 89Q, 8A, B3)</b>								
1.6	1.6	51	08.87-09.91	PP	4	ZM 012	ZS 124	
1.8	1.8	55	10.86-01.90	RU	4		ZS 124	
1.8	1.8	83	09.87-07.88	SD	4	ZM 002		
1.8 E	1.8	82	06.86-08.91	DZ	4	ZM 002		
1.8 E quattro	1.8	82	09.86-07.87	DZ	4	ZM 002		
1.8 E quattro	1.8	82	08.87-08.91	DZ	4	ZM 012		
1.8 quattro	1.8	83	09.86-07.87	SD	4	ZM 002		
1.8 quattro	1.8	83	08.87-08.88	SD	4	ZM 012		
1.8 S	1.8	65	09.86-12.90	SF	4	ZM 002		
1.8 S	1.8	66	09.86-10.91	PM Fgst.Nr.8A-M-000001→	4	ZM 002	ZSE 005	
1.8 S quattro	1.8	65	09.86-07.87	SF	4	ZM 002		
1.8 S quattro	1.8	65	08.87-07.90	SF	4	ZM 012		
1.8 S quattro	1.8	66	09.86-07.87	NE/PM/JN	4	ZM 002		
1.8 S quattro	1.8	66	08.87-09.91	NE/PM/JN	4	ZM 012		
2.0	2.0	82	10.90-08.91	AAD	4	ZM 012		
2.0 E	2.0	83	08.88-10.90	AAD	4	ZM 012		
2.0 E	2.0	83	08.88-10.90	3A	4		ZSE 005	
2.0 E quattro	2.0	83	08.88-09.90	AAD	4	ZM 012		
2.0 E quattro	2.0	83	08.88-09.90	3A	4		ZSE 005	
2.0 quattro	2.0	82	10.90-08.91	AAD	4	ZM 012		
2.0 quattro	2.0	82	10.90-08.91	3A	4		ZSE 005	
2.0 quattro	2.0	85	10.90-08.91	AAD	4	ZM 012	ZSE 005	
2.3 quattro	2.3	98	10.87-07.89	NG	5	ZM 002	ZSE 005	
<b>80 (8C, B4)</b>								
1.6	1.6	52	01.92-07.92	ABM	4		ZSE 001	
1.6	1.6	52	08.92-08.94	ABM	4		ZSE 005	
1.6 E	1.6	74	06.93-12.94	ADA	4		ZSE 005	
2.0	2.0	66	09.91-07.92	ABT	4		ZSE 001	
2.0	2.0	66	08.92-12.94	ABT	4		ZSE 005	
2.0 E	2.0	85	09.91-07.92	ABK	4		ZSE 001	
2.0 E	2.0	85	08.92-12.94	ABK	4		ZSE 005	
2.0 E 16V	2.0	103	08.92-12.94	ACE	4	ZM 031		
2.0 E 16V quattro	2.0	103	07.92-12.94	ACE	4	ZM 031		
2.0 E quattro	2.0	85	09.91-07.93	ABK Fgst.Nr.→8C..P.300000	4	ZM 001	ZSE 001	



kW

**AUDI****80 (8C, B4)**

2.0 E quattro	2.0	85	08.93-12.94	ABK Fgst.Nr.8C..R..300001→	4	ZM 001	ZSE 005	
2.3 E	2.3	98	09.91-12.94	NG	5	ZM 031		
2.3 E	2.3	98	07.94-12.94	NG	5		ZSE 005	
2.3 E quattro	2.3	98	09.91-12.94	NG	5	ZM 031		
2.3 E quattro	2.3	98	07.94-12.94	NG	5		ZSE 005	
2.6	2.6	110	07.92-12.94	ABC	6	ZM 027	ZSE 007	
2.6	2.6	110	07.92-12.94	ABC	6	ZM 063	ZSE 007	
2.6 quattro	2.6	110	06.92-12.94	ABC	6	ZM 027	ZSE 007	
2.6 quattro	2.6	110	06.92-12.94	ABC	6	ZM 063	ZSE 007	
2.8	2.8	128	09.91-12.94	AAH	6	ZM 027	ZSE 007	
2.8	2.8	128	09.91-12.94	AAH	6	ZM 063	ZSE 007	
2.8 quattro	2.8	128	09.91-12.94	AAH	6	ZM 027	ZSE 007	
2.8 quattro	2.8	128	09.91-12.94	AAH	6	ZM 063	ZSE 007	
S2 quattro	2.2	169	02.93-12.94	ABY	5	ZM 063	ZS 043	ZLE 233

**80 Avant (8C, B4)**

1.6 E	1.6	74	06.93-07.95	ADA	4		ZSE 005	
2.0	2.0	66	07.92-01.96	ABT	4		ZSE 001	
2.0	2.0	66	08.92-01.96	ABT	4		ZSE 005	
2.0 E	2.0	85	07.92-01.96	ABK	4		ZSE 001	
2.0 E	2.0	85	07.92-01.96	ABK	4		ZSE 002	
2.0 E	2.0	85	08.92-07.95	ABK	4		ZSE 005	
2.0 E 16V	2.0	103	02.93-01.96	ACE	4	ZM 031		
2.0 E 16V quattro	2.0	103	12.92-07.95	ACE	4	ZM 031		
2.3 E	2.3	98	07.92-01.96	NG	5		ZSE 005	
2.3 E	2.3	98	07.92-11.94	NG	5	ZM 031		
2.3 E quattro	2.3	98	09.91-11.94	NG	5	ZM 031	ZSE 005	
2.6	2.6	110	07.92-01.96	ABC	6	ZM 027	ZSE 007	
2.6	2.6	110	07.92-01.96	ABC	6	ZM 063	ZSE 007	
2.6 quattro	2.6	110	07.92-07.95	ABC	6	ZM 027	ZSE 007	
2.6 quattro	2.6	110	07.92-07.95	ABC	6	ZM 063	ZSE 007	
2.8	2.8	128	09.91-01.96	AAH	6	ZM 027	ZSE 007	
2.8	2.8	128	09.91-01.96	AAH	6	ZM 063	ZSE 007	
2.8 quattro	2.8	128	08.92-07.95	AAH	6	ZM 027	ZSE 007	
2.8 quattro	2.8	128	08.92-07.95	AAH	6	ZM 063	ZSE 007	
RS2 quattro	2.2	232	03.94-05.95	ADU	5	ZM 063	ZS 043	ZLE 233
S2 quattro	2.2	169	02.93-07.95	ABY	5	ZM 063		
S2 quattro	2.2	169	02.93-07.95	ABY	5		ZS 043	ZLE 233
S2 quattro	2.2	169	02.93-12.94	ABY	5	ZM 027		

**90 (81, 85, B2)**

2.0	2.0	85	10.84-07.85	JS/HP	5	ZM 002	ZS 124	
2.0 quattro	2.0	85	08.84-07.85	JS	5	ZM 002	ZS 124	
2.2	2.2	85	01.85-07.85	KX	5	ZM 002	ZS 124	
2.2	2.2	100	10.84-07.85	KV/HY	5	ZM 002	ZS 124	
2.2 E quattro	2.2	88	08.85-03.87	JT	5		ZS 124	
2.2 E quattro	2.2	100	11.84-07.85	KV	5	ZM 002	ZS 124	

**90 (89, 89Q, 8A, B3)**

2.0	2.0	85	07.88-09.91	PS	5	ZM 002	ZSE 005	
2.0 20 V	2.0	118	08.89-07.91	NM	5		ZSE 005	
2.0 20 V quattro	2.0	118	08.88-09.91	NM	5		ZSE 005	
2.2 E	2.2	100	04.87-07.91	KV	5	ZM 012		
2.2 E quattro	2.2	100	04.87-09.91	KV	5	ZM 012		
2.3 E	2.3	98	04.87-09.91	NG	5		ZSE 005	
2.3 E	2.3	100	04.87-07.91	NG	5	ZM 002	ZSE 005	
2.3 E 20V	2.3	123	04.90-07.91	7A	5		ZSE 005	
2.3 E 20V	2.3	125	08.88-07.91	7A	5		ZSE 005	
2.3 E 20V quattro	2.3	123	04.90-09.91	7A	5		ZSE 005	
2.3 E 20V quattro	2.3	125	06.88-09.91	7A	5		ZSE 005	
2.3 E quattro	2.3	100	04.87-07.91	NG	5	ZM 002	ZSE 005	
2.3 E quattro	2.3	98	04.87-09.91	NG	5	ZM 002	ZSE 005	



kW



## AUDI

## 100 (44, 44Q, C3)

1.8	1.8	55	08.84-07.85	DR	4		ZS 124	
1.8	1.8	55	08.82-09.86	RS/DR	4	ZM 002		
1.8	1.8	55	10.86-12.87	RS/DR	4	ZM 012		
1.8	1.8	65	10.86-07.88	SH	4	ZM 012		
1.8	1.8	65	02.86-09.86	SH	4	ZM 002		
1.8	1.8	66	08.84-07.85	JW/DS	4		ZS 124	
1.8	1.8	66	10.86-07.88	JW/NP/DS	4	ZM 012		
1.8	1.8	66	08.83-09.86	JW/NP/DS	4	ZM 002		
1.8 KAT	1.8	66	03.85-11.90	PH/4B	4	ZM 012		
1.8 quattro	1.8	65	10.86-07.88	SH	4	ZM 012		
1.8 quattro	1.8	65	08.86-09.86	SH	4	ZM 002		
1.8 quattro	1.8	66	10.86-07.88	JW/NP	4	ZM 012		
1.8 quattro	1.8	66	10.84-09.86	JW/NP	4	ZM 002		
1.8 quattro KAT	1.8	66	08.85-07.88	PH/4B	4	ZM 012		
1.9	1.9	74	08.82-07.84	WH	5	ZM 002		
2.0	2.0	83	08.86-09.86	SL	5	ZM 002		
2.0	2.0	83	10.86-11.87	SL	5	ZM 012		
2.0	2.0	85	08.84-09.86	KP	5	ZM 002		
2.0	2.0	85	10.86-12.87	KP	5	ZM 012		
2.0	2.0	85	08.84-12.87	KP	5		ZS 124	
2.0 KAT	2.0	85	01.88-11.90	RT	5			
2.0 KAT	2.0	85	01.88-11.90	RT	5	ZM 012	ZSE 005	
				Fgst.Nr.44-K-000001→				
2.1	2.1	100	08.82-07.84	WC	5	ZM 002		
2.2	2.2	101	08.84-07.85	KU	5		ZS 124	
2.2	2.2	101	08.84-09.86	KU	5	ZM 002		
2.2	2.2	101	10.86-12.88	KU	5	ZM 012		
2.2	2.2	85	10.84-09.86	KZ	5			
2.2 E quattro	2.2	88	08.85-07.86	PX	5	ZM 002		
2.2 E Turbo quattro	2.2	121	08.86-11.90	MC	5		ZSE 005	
2.2 KAT	2.2	101	06.89-11.90	KU/HX	5	ZM 012	ZS 124	
2.2 quattro	2.2	101	08.84-07.85	KU	5		ZS 124	
2.2 quattro	2.2	101	08.84-09.86	KU	5	ZM 002		
2.2 quattro	2.2	101	10.86-12.88	KU	5	ZM 012		
2.2 quattro KAT	2.2	101	06.89-11.90	KU/HX	5	ZM 012	ZS 124	
2.2 Turbo	2.2	121	08.86-11.90	MC	5		ZSE 005	
2.3 E	2.3	100	10.86-11.90	NF	5		ZSE 005	
2.3 E quattro	2.3	100	08.86-11.90	NF	5		ZSE 036	
<b>100 (4A, C4)</b>								
2.0	2.0	74	12.90-06.94	AAE	4		ZSE 001 <sup>202</sup>	
2.0	2.0	74	12.90-06.94	AAE	4		ZSE 036 <sup>202</sup>	
2.0 E	2.0	85	12.90-06.94	ABK/AAD	4		ZSE 036	
2.0 E 16V	2.0	103	01.92-06.94	ACE	4	ZM 031	ZSE 036	
2.0 E 16V quattro	2.0	103	07.92-06.94	ACE	4		ZSE 036	
2.3 E	2.3	98	12.90-06.94	AAR	5	ZM 031	ZSE 005 <sup>202</sup>	
2.3 E	2.3	98	12.90-06.94	AAR	5	ZM 031	ZSE 036 <sup>202</sup>	
2.3 E quattro	2.3	98	12.90-06.94	AAR	5	ZM 031	ZSE 036	
2.6	2.6	110	03.92-06.94	ABC	6	ZM 027	ZSE 007	
2.6	2.6	110	03.92-06.94	ABC	6	ZM 063	ZSE 007	
2.6 quattro	2.6	110	04.92-06.94	ABC	6	ZM 027	ZSE 007	
2.6 quattro	2.6	110	04.92-06.94	ABC	6	ZM 063	ZSE 007	
2.8 E	2.8	128	12.90-06.94	AAH	6	ZM 027	ZSE 007	
2.8 E	2.8	128	12.90-06.94	AAH	6	ZM 063	ZSE 007	
2.8 E quattro	2.8	128	12.90-06.94	AAH	6	ZM 027	ZSE 007	
2.8 E quattro	2.8	128	12.90-06.94	AAH	6	ZM 063	ZSE 007	
S4 Turbo quattro	2.2	169	08.91-06.94	AAN	5	ZM 063	ZS 043	ZLE 233
S4 V8 quattro	4.2	206	10.92-06.94	ABH	8		ZSE 036	
S4 V8 quattro	4.2	213	03.94-06.94	AEC	8		ZS 012	
<b>100 Avant (44, 44Q, C3)</b>								
1.8	1.8	55	08.82-07.85	RS/DR	4		ZS 124	
1.8	1.8	55	08.82-09.86	RS/DR	4	ZM 002		



kW

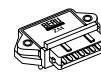

## AUDI

## 100 Avant (44, 44Q, C3)

1.8	1.8	55	10.86–12.87	RS/DR	4	ZM 012		
1.8	1.8	65	10.86–07.90	SH	4	ZM 012		
1.8	1.8	65	02.86–09.86	SH	4	ZM 002		
1.8	1.8	66	08.83–07.85	JW	4		ZS 124	
1.8	1.8	66	10.86–07.89	JW /NP/DS	4	ZM 012		
1.8	1.8	66	08.83–09.86	JW /NP/DS	4	ZM 002		
1.8 KAT	1.8	66	03.85–11.90	PH/4B	4	ZM 012	ZSE 001	
1.8 quattro	1.8	65	10.86–07.90	SH	4	ZM 012		
1.8 quattro	1.8	65	08.86–09.86	SH	4	ZM 002		
1.8 quattro	1.8	66	10.86–07.88	JW /NP	4	ZM 012		
1.8 quattro	1.8	66	10.84–09.86	JW /NP	4	ZM 002		
1.8 quattro KAT	1.8	66	08.85–10.90	PH/4B	4	ZM 012		
1.9	1.9	74	02.83–07.84	WH	5	ZM 002		
2.0	2.0	83	09.86–09.86	SL	5	ZM 002		
2.0	2.0	83	10.86–11.87	SL	5	ZM 012		
2.0 E	2.0	85	01.85–09.86	KP	5	ZM 002		
2.0 E	2.0	85	10.86–12.87	KP	5	ZM 012		
2.0 E	2.0	85	01.85–12.87	KP	5		ZS 124	
2.0 E KAT	2.0	85	01.88–11.90	RT	5	ZM 012	ZSE 005	
				Fgst.Nr.44-K-000001→				
2.1	2.1	100	08.82–07.84	WC	5	ZM 002		
2.2	2.2	85	10.84–07.85	KZ	5		ZS 124	
2.2	2.2	85	10.84–09.86	KZ	5	ZM 002 <sup>283</sup>		
2.2	2.2	101	08.84–07.85	KU	5		ZS 124	
2.2	2.2	101	08.84–09.86	KU	5	ZM 002		
2.2	2.2	101	10.86–12.88	KU	5	ZM 012		
2.2 E quattro	2.2	88	08.85–07.86	PX	5	ZM 002		
2.2 KAT	2.2	101	06.89–11.90	KU/HX	5	ZM 012	ZS 124	
2.2 quattro	2.2	101	08.84–09.86	KU	5	ZM 002	ZS 124	
2.2 quattro	2.2	101	10.86–12.88	KU	5	ZM 012	ZS 124	
2.2 quattro KAT	2.2	101	06.89–11.90	KU/HX	5	ZM 012	ZS 124	
2.2 Turbo	2.2	121	08.86–11.90	MC	5		ZSE 005	
2.2 Turbo quattro	2.2	121	08.86–11.90	MC	5		ZSE 005	
				Fgst.Nr.F44-J-250001→				
2.3	2.3	100	08.86–11.90	NF	5		ZSE 005	
2.3 E quattro	2.3	100	08.86–11.90	NF	5		ZSE 036	

## 100 Avant (4A, C4)

2.0 E	2.0	74	09.91–06.94	AAE	4		ZSE 001 <sup>202</sup>	
2.0 E	2.0	74	09.91–06.94	AAE	4		ZSE 036 <sup>202</sup>	
2.0 E	2.0	85	09.91–06.94	ABK/AAD	4		ZSE 036	
2.0 E 16V	2.0	103	07.92–06.94	ACE	4	ZM 031	ZSE 036	
2.0 E 16V quattro	2.0	103	07.92–06.94	ACE	4	ZM 031	ZSE 036	
2.3 E	2.3	98	09.91–06.94	AAR	5	ZM 031	ZSE 036	
2.3 E quattro	2.3	98	09.91–06.94	AAR	5	ZM 031	ZSE 036	
2.6	2.6	110	03.92–06.94	ABC	6	ZM 027	ZSE 007	
2.6	2.6	110	03.92–06.94	ABC	6	ZM 063	ZSE 007	
2.6 quattro	2.6	110	07.92–06.94	ABC	6	ZM 027	ZSE 007	
2.6 quattro	2.6	110	07.92–06.94	ABC	6	ZM 063	ZSE 007	
2.8 E	2.8	128	09.91–06.94	AAH	6	ZM 027	ZSE 007	
2.8 E	2.8	128	09.91–06.94	AAH	6	ZM 063	ZSE 007	
2.8 E quattro	2.8	128	09.91–06.94	AAH	6	ZM 027	ZSE 007	
2.8 E quattro	2.8	128	09.91–06.94	AAH	6	ZM 063	ZSE 007	
S4 Turbo quattro	2.2	169	09.91–06.94	AAN	5		ZS 043	ZLE 233
S4 V8 quattro	4.2	206	10.92–06.94	ABH	8		ZSE 036	
S4 V8 quattro	4.2	213	03.94–06.94	AEC	8		ZS 012	

## 200 (44, 44Q)

2.1 5 E	2.1	100	08.83–07.84	WC	5	ZM 002	ZS 280	
2.2	2.2	101	08.84–07.85	KU	5	ZM 002	ZS 280	
2.2 20V Turbo quattro	2.2	162	03.89–12.90	3B	5	ZM 012	ZSE 005	
2.2 20V Turbo quattro	2.2	162	03.89–12.90	3B	5	ZM 030	ZSE 005	
2.2 Turbo	2.2	121	08.85–09.91	MC	5		ZSE 005	



kW



AUDI								
<b>200 (44, 44Q)</b>								
2.2 Turbo	2.2	140	02.88–12.90	2B	5	ZM 030	ZSE 005	
2.2 Turbo	2.2	147	02.88–12.90	1B	5	ZM 030	ZSE 005	
2.2 Turbo quattro	2.2	121	01.85–12.91	MC	5		ZSE 036	
				Fgst.Nr.44-K-000001→				
2.2 Turbo quattro	2.2	147	02.88–11.90	1B	5	ZM 030	ZSE 005	
<b>200 Avant (44, 44Q)</b>								
2.2 20V Turbo quattro	2.2	162	07.89–12.90	3B	5	ZM 012	ZSE 005	
2.2 20V Turbo quattro	2.2	162	07.89–12.90	3B	5	ZM 030	ZSE 005	
2.2 Turbo	2.2	121	08.85–09.91	MC	5		ZSE 005	
2.2 Turbo quattro	2.2	121	09.83–12.90	MC	5		ZSE 036	
				Fgst.Nr.44-K-000001→				
2.2 Turbo quattro	2.2	147	02.88–12.91	1B	5	ZM 030	ZSE 005	
<b>AUSTIN</b>								
<b>ALLEGRO Stufenheck</b>								
1.3	1.3	46	12.79–12.84	12 H	4		ZS 106	
<b>MINI MK I</b>								
1000 Mayfair	1.0	31	08.82–08.88	99 HC20P/99 HA53P/99 H997P	4		ZS 106	
<b>BMW</b>								
<b>1 (E81)</b>								
116 i	1.6	85	03.07–06.09	N45 B16 A	4		ZS 324	
116 i	1.6	90	03.07–06.09	N45 B16 A	4		ZS 324 <sup>202</sup>	
116 i	1.6	90	03.07–06.09	N45 B16 A	4		ZSE 144 <sup>202</sup>	
116 i	2.0	90	03.09–12.11	N43 B20 A	4		ZSE 144	
118 i	2.0	95	09.06–06.09	N46 B20 B	4		ZS 324	
118 i	2.0	105	05.07–12.11	N46 B20 B/N43 B20 A	4		ZSE 144	
120 i	2.0	120	05.07–12.11	N46 B20 B/N43 B20 A/N46 B20 C	4		ZSE 144	
120 i	2.0	125	05.07–12.11	N46 B20 B/N43 B20 A/N46 B20 C	4		ZSE 144	
130 i	3.0	190	09.09–12.11	N52 B30 A	6		ZSE 143	
130 i	3.0	195	11.07–08.09	N52 B30 A	6		ZSE 143	
130 i	3.0	195	09.06–09.12	N52 B30 A/N52 B30 BF/N52 B30 B	6		ZSE 145	
<b>1 (E87)</b>								
116 i	1.6	85	11.03–06.09	N45 B16 A	4		ZS 324	
118 i	2.0	95	07.04–06.09	N46 B20 B	4		ZS 324	
120 i	2.0	110	11.03–06.09	N46 B20 B	4		ZS 324	
<b>1 Cabriolet (E88)</b>								
118 i	2.0	105	03.08–02.12	N43 B20 A	4		ZSE 144	
120 i	2.0	120	03.08–02.12	N43 B20 A	4		ZSE 144	
120 i	2.0	125	03.08–02.12	N43 B20 A	4		ZSE 144	
125 i	3.0	160	03.08–	N52 B30 A	6		ZSE 143	
135 i	3.0	225	03.08–02.10	N54 B30 A	6		ZSE 143	
<b>1 Coupe (E82)</b>								
120 i	2.0	125	09.09–02.12	N46 B20 B/N43 B20 A	4		ZSE 144	
125 i	3.0	160	03.08–	N53 B30 A	6		ZSE 143	
135 i	3.0	225	10.07–02.10	N54 B30 A	6		ZSE 143	
M	3.0	250	04.11–06.12	N54 B30 A	6		ZSE 143	
<b>3 (E30)</b>								
315	1.6	55	09.82–12.91	M10 B16	4	ZM 001		
316	1.8	66	09.82–12.87	M10 B18	4	ZM 001		
316 i	1.6	73	09.88–06.91	M40 B16	4		ZS 121	
318 i	1.8	75	01.85–08.88	M10 B18	4	ZM 038		
318 i	1.8	77	09.82–08.87	M10 B18	4	ZM 038		
318 i	1.8	83	09.87–06.91	M40 B18	4	ZM 038	ZS 122	
318 i	1.8	85	09.87–06.91	M40 B18	4		ZS 122	
318 i	1.8	85	09.87–11.90	M40 B18	4	ZM 038		
320 i	2.0	92	09.84–12.85	M20 B20	6	ZM 038		
320 i	2.0	95	04.89–06.91	M20 B20	6		ZS 122	
320 i	2.0	95	12.86–11.90	M20 B20	6	ZM 038		
320 is	2.0	141	05.88–12.90	S14 204 EA	4		ZS 122	
323 i	2.3	110	09.83–08.86	M20 B23	6	ZM 001		





kW

**BMW****3 (E30)**

325 e 2.7	2.7	90	01.85–12.88	M20 B27	6	ZS 122	
325 e 2.7	2.7	95	01.85–08.87	M20 B27	6	ZS 122	
325 i	2.5	125	12.86–06.91	M20 B25	6	ZS 122	
325 i	2.5	126	09.85–11.89	M20 B25	6	ZS 122	
325 i X	2.5	126	03.86–12.87	M20 B25	6	ZS 122	
M3 2.3	2.3	143	07.86–06.91	S14 B23	4	ZS 122	
M3 2.3	2.3	147	02.87–05.89	S14 B23	4	ZS 122	
M3 2.3	2.3	158	06.89–06.91	S14 B23	4	ZS 122	
M3 EVO I 2.3	2.3	162	10.88–10.90	S14 B23 (EVO I)	4	ZS 122	
M3 EVO II 2.5	2.5	175	01.90–01.92	S14 B25 (EVO II)	4	ZS 122	

**3 (E36)**

316 i	1.6	73	09.90–09.93	M40 B16	4	ZS 122	
316 i	1.6	75	07.93–02.98	M43 B16	4	ZS 307	
316 i	1.6	75	09.90–09.93	M43 B16	4	ZS 307	
318 i	1.8	83	12.90–10.93	M40 B18	4	ZS 122	
318 i	1.8	85	10.93–02.98	M43 B18	4	ZS 307	
318 is	1.8	103	03.93–02.98	M42 B18	4	ZS 307	
318 is	1.8	103	03.93–09.93	M42 B18	4	ZS 014	ZLE 232
318 is	1.9	103	09.95–02.98	M44 B19	4	ZS 307	
320 i	2.0	110	09.94–02.98	M52B (20 6 S3) Vanos	6	ZS 302	
320 i	2.0	110	09.90–12.95	M50B (20 6 S1) , M50B (20 6 S2) Vanos	6	ZS 014	ZLE 232
323 i 2.5	2.5	125	03.95–02.98	M52 B25 (Vanos)	6	ZS 302	
325 i	2.5	141	09.90–09.95	M 50 B 25	6	ZS 014	ZLE 232
328 i	2.8	142	01.95–02.98	M52 B28/M52 B28 TU	6	ZS 302	
M3 3.2	3.2	236	09.95–02.98	S50 B32	6	ZS 302	

**3 (E46)**

316 i	1.6	77	04.00–02.05	M43 B16 (164E3)/M43 B16	4	ZS 307	
316 i	1.6	85	06.02–02.05	N45 B16 A , N45 B16	4	ZS 324	
316 i	1.8	85	03.03–02.05	N42 B18 , N46 B18 A , N46 B18	4	ZS 324	
316 i	1.9	77	09.98–02.05	M43 B19 (194E1)	4	ZS 307	
318 i	1.9	87	02.98–09.01	M43 B19/M43 B19 TU	4	ZS 307	
318 i	2.0	105	03.03–02.05	N42 B20 , N46 B20 A , N46 B20	4	ZS 324	
320 i	2.0	110	03.98–09.00	M52 B(20 6 S3) Vanos/M52 B20	6	ZS 302	
320 i	2.2	125	09.00–09.02	M54 226 S1/M54 B22	6	ZS 302	
320 i	2.2	125	10.02–02.05	M54 B22 , M54 226 S1	6	ZS 324	
323 i	2.5	125	03.98–09.00	M52 B25 TU/M52 B25 (Vanos)	6	ZS 302	
325 i	2.5	141	09.00–09.02	M54 256 S5/M54 B25	6	ZS 302	
325 i	2.5	141	10.02–02.05	M54 256 S5/M54 B25	6	ZS 324	
325 xi	2.5	141	09.00–09.02	M54 256 S5	6	ZS 302	
325 xi	2.5	141	10.02–02.05	M54 256 S5	6	ZS 324	
328 i	2.8	142	02.98–06.00	M52 B28	6	ZS 302	
330 i	3.0	170	06.00–09.02	M54 B30 /M54 306 S3	6	ZS 302	
330 i	3.0	170	10.02–02.05	M54 B30 /M54 306 S3	6	ZS 324	
330 xi	3.0	170	06.00–09.02	M54 306 S3	6	ZS 302	
330 xi	3.0	170	10.02–02.05	M54 306 S3	6	ZS 324	

**3 (E90)**

316 i	1.6	85	02.06–06.09	N45 B16/N45 B16 TU2/N45 B16 A	4	ZS 324	
316 i	1.6	90	09.07–12.11	N43 B16 A	4	ZSE 144	
318 i	2.0	95	09.05–03.07	N46 B20 B/N46 B20	4	ZS 324	
318 i	2.0	105	09.07–12.11	N43 B20 A	4	ZSE 144	
320 i	2.0	110	01.05–03.07	N46 B20 A/N46 B20/N46 B20 C	4	ZS 324	
320 i	2.0	125	09.07–12.11	N43 B20 A	4	ZSE 144	
320 si	2.0	127	05.06–06.09	N45 B20 A	4	ZS 324	
323 i	2.5	130	04.06–04.06	N52 B25 A/N52N B25 A	6	ZSE 145	
325 i	2.5	160	01.05–04.06	N52 B25/N52 B25 A	6	ZSE 145	
325 i	2.5	160	11.07–12.11	N52 B25/N52 B25 A	6	ZSE 143	
325 i	3.0	160	09.07–12.11	N53 B30/N53 B30 A	6	ZSE 144	
325 i xDrive	3.0	160	09.08–12.11	N53 B30 A	6	ZSE 144	
325 xi	2.5	160	09.05–04.06	N52 B25 A	6	ZSE 145	
325 xi	2.5	160	11.07–12.11	N52 B25 A	6	ZSE 143	
325 xi	3.0	160	09.07–08.08	N53 B30 A	6	ZSE 144	



kW

**BMW****3 (E90)**

330 i	3.0	190	01.05–04.06	N52 B30 A/N52 B30	6		<b>ZSE 145</b>	
330 i	3.0	190	11.07–12.11	N52 B30 A/N52 B30	6		<b>ZSE 143</b>	
330 i	3.0	200	09.07–12.11	N53 B30 A	6		<b>ZSE 143</b> <sup>202</sup>	
330 i	3.0	200	09.07–12.11	N53 B30 A	6		<b>ZSE 144</b> <sup>202</sup>	
330 i xDrive	3.0	200	09.08–12.11	N53 B30 A	6		<b>ZSE 144</b>	
330 xi	3.0	190	09.05–04.06	N52 B30 A	6		<b>ZSE 145</b>	
330 xi	3.0	200	09.07–08.08	N53 B30 A	6		<b>ZSE 144</b>	
335 i	3.0	225	09.06–02.10	N54 B30 A	6		<b>ZSE 143</b>	
335 i xDrive	3.0	225	09.08–02.10	N54 B30 A	6		<b>ZSE 143</b>	
335 xi	3.0	225	09.07–08.08	N54 B30 A	6		<b>ZSE 143</b>	

**3 Cabriolet (E30)**

318 i	1.8	83	09.90–10.93	M40 B18	4	<b>ZM 038</b>	<b>ZS 122</b>	
320 i	2.0	95	04.86–10.93	M20 B20	6		<b>ZS 122</b>	
320 i	2.0	95	04.86–11.89	M20 B20	6	<b>ZM 038</b>		
325 i	2.5	125	09.87–10.93	M20 B25	6		<b>ZS 122</b>	
325 i	2.5	126	12.85–12.87	M20 B25	6		<b>ZS 122</b>	
M3 2.3	2.3	143	06.88–06.91	S14 B23	4		<b>ZS 122</b>	

**3 Cabriolet (E36)**

318 i	1.8	85	01.94–04.99	M43 B18	4		<b>ZS 307</b>	
320 i	2.0	110	12.93–12.95	M 50 B	6		<b>ZS 014</b>	<b>ZLE 232</b>
320 i	2.0	110	09.94–12.95	M50B (20 6 S2) Vanos, M52B (20 6 S3) Vanos	6		<b>ZS 302</b>	
323 i	2.5	125	06.95–04.99	M52 B25 (Vanos)	6		<b>ZS 302</b>	
325 i	2.5	141	03.93–03.95	M50 B25/M50 B25 TU	6		<b>ZS 014</b>	<b>ZLE 232</b>
328 i	2.8	142	03.95–04.99	M52 B28/M52 B28 TU	6		<b>ZS 302</b>	
M3 3.2	3.2	236	10.95–04.99	S50 B32	6		<b>ZS 302</b>	

**3 Cabriolet (E46)**

318 Ci	2.0	105	03.03–06.09	N42 B20 , N46 B20	4		<b>ZS 324</b>	
318 Ci	2.0	110	02.05–06.09	N46 B20 B	4		<b>ZS 324</b>	
320 Ci	2.2	125	09.00–09.02	M54 226 S1/M54 B22	6		<b>ZS 302</b>	
320 Ci	2.2	125	10.02–06.09	M54 226 S1/M54 B22	6		<b>ZS 324</b>	
323 Ci	2.5	125	04.00–09.00	M52 B25 (Vanos)	6		<b>ZS 302</b>	
325 Ci	2.5	141	09.00–09.02	M54 256 S5	6		<b>ZS 302</b>	
325 Ci	2.5	141	10.02–06.09	M54 256 S5	6		<b>ZS 324</b>	
330 Ci	3.0	170	06.00–09.02	M54 306 S3	6		<b>ZS 302</b>	
330 Ci	3.0	170	10.02–06.09	M54 306 S3	6		<b>ZS 324</b>	
M3 3.2	3.2	252	04.01–06.09	S54 326 S4/S54 B32	6		<b>ZS 324</b>	

**3 Cabriolet (E93)**

318 i	2.0	105	03.10–02.12	N43 B20 A	4		<b>ZSE 144</b>	
320 i	2.0	110	03.07–08.07	N46N B20 B , N46 B20	4		<b>ZS 324</b>	
320 i	2.0	125	03.07–02.12	N43 B20 A	4		<b>ZSE 144</b>	
325 i	2.5	160	11.07–	N52 B25/M52 B25 A	6		<b>ZSE 143</b>	
325 i	3.0	160	03.07–02.12	N53 B30/N53 B30 A	6		<b>ZSE 144</b>	
330 i	3.0	190	11.07–01.13	N52N B30 B	6		<b>ZSE 143</b>	
330 i	3.0	200	03.07–02.12	N53 B30/N53 B30 A	6		<b>ZSE 143</b> <sup>202</sup>	
330 i	3.0	200	03.07–02.12	N53 B30/N53 B30 A	6		<b>ZSE 144</b> <sup>202</sup>	
335 i	3.0	225	03.07–02.10	N54 B30 B	6		<b>ZSE 143</b>	

**3 Compact (E36)**

316 g	1.6	75	12.95–08.00	M43 B16	4		<b>ZS 307</b>	
316 i	1.6	75	03.94–08.00	M43 B16	4		<b>ZS 307</b>	
316 i	1.9	77	12.98–08.00	M43 B19 (194E1)	4		<b>ZS 307</b>	
318 ti	1.8	103	11.94–08.95	M42 B18	4		<b>ZS 307</b>	
318 ti	1.9	103	07.95–08.00	M44 B19	4		<b>ZS 307</b>	
323 ti	2.5	125	08.97–08.00	M52 B25 (Vanos)	6		<b>ZS 302</b>	

**3 Compact (E46)**

316 ti	1.6	85	06.02–02.05	N40 B16 A , N45 B16 A	4		<b>ZS 324</b>	
316 ti	1.8	85	03.03–02.05	N42 B18 , N46 B18 A	4		<b>ZS 324</b>	
318 ti	2.0	105	03.03–02.05	N42 B20 , N46 B20 A	4		<b>ZS 324</b>	
325 ti	2.5	141	10.02–02.05	M54 256 S5/M54 B25	6		<b>ZS 324</b>	
325 ti	2.5	141	06.01–09.02	M54 256 S5/M54 B25	6		<b>ZS 302</b>	

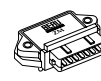

kW

**BMW****3 Coupe (E36)**

316 i	1.6	75	09.93-04.99	M43 B16	4		<b>ZS 307</b>	
318 is	1.8	103	03.92-09.93	M42 B18	4		<b>ZS 014</b>	<b>ZLE 232</b>
318 is	1.8	103	03.92-10.95	M42 B18	4		<b>ZS 307</b>	
318 is	1.9	103	09.95-04.99	M44 B19	4		<b>ZS 307</b>	
320 i	2.0	110	09.94-04.99	M52B (20 6 S3) Vanos	6		<b>ZS 302</b>	
320 i	2.0	110	03.92-12.95	M 50 B	6		<b>ZS 014</b>	<b>ZLE 232</b>
323 i	2.5	125	03.95-04.99	M52 B25 (Vanos)	6		<b>ZS 302</b>	
325 i	2.5	141	03.92-12.95	M50 B25/M50 B25 TU/M50 B25 (Vanos)	6		<b>ZS 014</b>	<b>ZLE 232</b>
328 i	2.8	142	01.95-04.99	M52 B28/M52 B28 TU	6		<b>ZS 302</b>	
M3 3.2	3.2	236	10.95-04.99	S50 B32	6		<b>ZS 302</b>	

**3 Coupe (E46)**

316 Ci	1.6	77	04.00-	M43 B16 (164E3)	4		<b>ZS 307</b>	
316 Ci	1.6	85	06.02-06.09	N45 B16 A	4		<b>ZS 324</b>	
318 Ci	1.9	87	11.99-09.01	M43 B19	4		<b>ZS 307</b>	
318 Ci	2.0	105	03.03-06.09	N42 B20 , N46 B20	4		<b>ZS 324</b>	
320 Ci	2.0	110	08.99-09.00	M52 B(20 6 S4)/M52 B20	6		<b>ZS 302</b>	
320 Ci	2.2	125	09.00-09.02	M54 226 S1/M54 B22	6		<b>ZS 302</b>	
320 Ci	2.2	125	10.02-06.09	M54 226 S1/M54 B22	6		<b>ZS 324</b>	
323 Ci	2.5	125	04.99-09.00	M52 B25 (Vanos)	6		<b>ZS 302</b>	
325 Ci	2.5	141	09.00-09.02	M54 256 S5	6		<b>ZS 302</b>	
325 Ci	2.5	141	10.02-06.09	M54 256 S5	6		<b>ZS 324</b>	
328 Ci	2.8	142	04.99-06.00	M52 B28	6		<b>ZS 302</b>	
330 Ci	3.0	170	06.00-09.02	M54 306 S3	6		<b>ZS 302</b>	
330 Ci	3.0	170	10.02-06.09	M54 306 S3	6		<b>ZS 324</b>	
330 xi	3.0	170	06.00-09.02	M54 306 S3	6		<b>ZS 302</b>	
M3 3.2	3.2	252	06.00-06.09	S54 326 S4/S54 B32	6		<b>ZS 324</b>	
M3 CSL	3.2	265	06.03-06.09	S54N 326 S4/S54 B32	6		<b>ZS 324</b>	

**3 Coupe (E92)**

318 i	2.0	105	03.10-02.12	N43 B20 A	4		<b>ZSE 144</b>	
320 i	2.0	110	11.06-06.07	N46 B20 A , N46N B20 B	4		<b>ZS 324</b>	
320 i	2.0	125	03.07-02.12	N43 B20 A	4		<b>ZSE 144</b>	
325 i	2.5	160	11.07-	N52 B25	6		<b>ZSE 143</b>	
325 i	3.0	160	09.07-02.12	N53 B30/N53 B30 A	6		<b>ZSE 144</b>	
325 i xDrive	3.0	160	09.08-02.12	N53 B30 A	6		<b>ZSE 144</b>	
325 xi	2.5	160	11.07-08.08	N52 B25 A	6		<b>ZSE 143</b>	
325 xi	3.0	160	09.07-08.08	N53 B30 A	6		<b>ZSE 144</b>	
330 i	3.0	190	11.07-08.12	N52 B30 A	6		<b>ZSE 143</b>	
330 i	3.0	200	09.07-02.12	N53 B30/N53 B30 A	6		<b>ZSE 143<sup>202</sup></b>	
330 i	3.0	200	09.07-02.12	N53 B30/N53 B30 A	6		<b>ZSE 144<sup>202</sup></b>	
330 i xDrive	3.0	200	09.08-02.12	N53 B30 A	6		<b>ZSE 144</b>	
335 i	3.0	225	09.06-02.10	N54 B30 A	6		<b>ZSE 143</b>	
335 i xDrive	3.0	225	09.08-02.10	N54 B30 A	6		<b>ZSE 143</b>	
335 xi	3.0	225	09.07-08.08	N54 B30 A	6		<b>ZSE 143</b>	

**3 Touring (E30)**

316 i	1.6	75	09.91-06.94	M40 B16	4		<b>ZS 122</b>	
318 i	1.8	83	04.89-06.94	M40 B18	4	<b>ZM 038</b>	<b>ZS 122</b>	
318 i	1.8	85	04.89-06.91	M40 B18	4		<b>ZS 122</b>	
318 i	1.8	85	09.87-11.90	M40 B18	4	<b>ZM 038</b>		
320 i	2.0	95	01.88-11.89	M20 B20	6	<b>ZM 038</b>		
320 i	2.0	95	01.88-12.91	M20 B20	6		<b>ZS 122</b>	
325 i	2.5	125	07.87-03.93	M20 B25	6		<b>ZS 122</b>	
325 i X	2.5	125	06.88-10.93	M20 B25	6		<b>ZS 122</b>	

**3 Touring (E36)**

316 i	1.6	75	01.96-10.99	M43 B16	4		<b>ZS 307</b>	
318 i	1.8	85	07.95-10.99	M43 B18	4		<b>ZS 307</b>	
320 i	2.0	110	01.95-10.99	M52 B(20 6 S3) Vanos/M50 B20/M52 B20/ M50 B20 TU	6		<b>ZS 302</b>	
323 i	2.5	125	09.95-10.99	M52 B25 (Vanos)	6		<b>ZS 302</b>	
328 i	2.8	142	01.95-10.99	M52 B28/M52 B28 TU	6		<b>ZS 302</b>	



kW

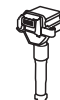
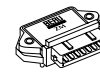

BMW							
<b>3 Touring (E46)</b>							
316 i	1.8	85	03.03–02.05	N42 B18 , N46 B18 A , N46 B18	4		ZS 324
318 i	1.9	87	10.99–09.01	M43 B19/M43 B19 TU	4		ZS 307
318 i	2.0	105	09.01–02.05	N46 B20 A , N46 B20	4		ZS 324
320 i	2.0	110	10.99–09.00	M52 B(20 6 S3) Vanos/M52 B20	6		ZS 302
320 i	2.2	125	09.00–09.02	M54 226 S1/M54 B22	6		ZS 302
320 i	2.2	125	10.02–02.05	M54 226 S1/M54 B22	6		ZS 324
325 i	2.5	141	10.02–02.05	M54 256 S5/M54 B25	6		ZS 324
325 i	2.5	141	09.00–09.02	M54 256 S5/M54 B25	6		ZS 302
325 xi	2.5	141	09.00–09.02	M54 256 S5	6		ZS 302
325 xi	2.5	141	10.02–02.05	M54 256 S5	6		ZS 324
328 i	2.8	142	10.99–06.00	M52 B28	6		ZS 302
330 i	3.0	170	06.00–09.02	M54 B30 /M54 306 S3	6		ZS 302
330 i	3.0	170	10.02–02.05	M54 B30 /M54 306 S3	6		ZS 324
330 xi	3.0	170	06.00–09.02	M54 306 S3	6		ZS 302
330 xi	3.0	170	10.02–02.05	M54 306 S3	6		ZS 324
<b>3 Touring (E91)</b>							
316 i	1.6	90	09.08–02.12	N43 B16 A	4		ZSE 144
318 i	2.0	95	01.06–06.09	N46 B20 B , N46 B20	4		ZS 324
318 i	2.0	100	09.07–02.12	N46 B20 B	4		ZSE 144
318 i	2.0	105	09.07–02.12	N43 B20 A	4		ZSE 144
320 i	2.0	110	09.05–06.09	N46 B20 A , N46 B20 C , N46 B20	4		ZS 324
320 i	2.0	125	09.07–02.12	N43 B20 A	4		ZSE 144
325 i	2.5	160	09.05–04.06	N52 B25/N52 B25 A	6		ZSE 145
325 i	2.5	160	11.07–	N52 B25/N52 B25 A	6		ZSE 143
325 i	3.0	160	09.07–02.12	N53 B30/N53 B30 A	6		ZSE 144
325 i xDrive	3.0	160	09.08–02.12	N53 B30 A	6		ZSE 144
325 xi	3.0	160	09.07–08.08	N53 B30 A	6		ZSE 144
330 i	3.0	190	09.05–04.06	N52 B30 A/N52 B30	6		ZSE 145
330 i	3.0	190	11.07–	N52 B30 A/N52 B30	6		ZSE 143
330 i	3.0	200	09.07–02.12	N53 B30	6		ZSE 144
330 i xDrive	3.0	200	09.08–02.12	N53 B30 A	6		ZSE 144
330 xi	3.0	190	09.05–04.06	N52 B30 A	6		ZSE 145
330 xi	3.0	200	09.07–08.08	N53 B30 A	6		ZSE 144
335 i	3.0	225	09.06–02.10	N54 B30 A	6		ZSE 143
335 i xDrive	3.0	225	09.08–02.10	N54 B30 A	6		ZSE 143
335 xi	3.0	225	09.07–08.08	N54 B30 A	6		ZSE 143
<b>5 (E28)</b>							
518	1.8	66	01.84–08.84	M10 B18	4	ZM 038	
518 i	1.8	77	09.83–08.84	M10 B18	4	ZM 001	
518 i	1.8	77	09.84–12.87	M10 B18	4	ZM 038	
520 i	2.0	92	06.81–08.84	M20 B20	6	ZM 001	
520 i	2.0	92	09.84–12.87	M20 B20	6	ZM 038	
520 i	2.0	95	12.86–12.87	M20 B20	6	ZM 038	ZS 122
525 e	2.7	90	09.81–12.87	M20 B27	6		ZS 122
525 e	2.7	92	05.83–12.87	M20 B27	6		ZS 122
525 e	2.7	95	12.84–12.87	M20 B27	6		ZS 122
525 i	2.5	110	06.81–12.87	M20 B25E	6	ZM 001	
535 i, M 535 i	3.4	136	01.85–12.87	M30 B35	6		ZS 122
535 i, M 535 i	3.4	141	01.85–12.87	M30 B35 (Motronic)	6		ZS 122
535 i, M 535 i	3.4	160	01.85–12.87	M30 B35	6		ZS 122
M 3.5	3.5	211	08.85–12.87	S38 B35	6		ZS 122
<b>5 (E34)</b>							
518 i	1.8	83	08.89–09.95	M40 B18	4		ZS 122
518 i	1.8	85	08.89–09.95	M43 B18	4		ZS 307
520 i	2.0	95	01.88–08.91	M20 B20	6		ZS 122
520 i 24V	2.0	110	09.89–09.95	M50 B(20 6 S2) Vanos/M50 B20/ M50 B(20 6 S1)/M50 B20 TU	6		ZS 014 ZLE 232
525 i	2.5	125	01.88–08.91	M20 B25	6		ZS 122
525 i 24V	2.5	141	09.89–09.95	M50 B25/M52 B25 (Vanos)/M50 B25 TU	6		ZS 014 ZLE 232
525 iX 24V	2.5	141	10.91–09.95	M52 B25 (Vanos)	6		ZS 014 ZLE 232
530 i	3.0	138	01.88–08.91	M30 B30	6		ZS 122

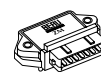

kW

**BMW****5 (E34)**

530 i V8	3.0	160	09.92–09.95	M60 B30	8	ZS 014	ZLE 232
535 i	3.4	155	01.88–09.95	M30 B35	6	ZS 122	
540 i V8	4.0	210	09.92–09.95	M60 B40	8	ZS 014	ZLE 232
M 3.8	3.8	250	03.92–09.95	S38 B38	6	ZS 014	ZLE 232

**5 (E39)**

520 i	2.0	110	01.96–09.00	M52 B(20 6 S3) Vanos/ M52 B(20 6 S4)/M52 B20	6	ZS 302	
520 i	2.2	125	09.00–09.02	M54 B22	6	ZS 302	
520 i	2.2	125	10.02–06.03	M54 B22	6	ZS 324	
523 i	2.5	125	11.95–09.00	M52 B25 TU/M52 B25 (Vanos)	6	ZS 302	
525 i	2.5	141	09.00–09.02	M54 256 S5/M54 B25	6	ZS 302	
528 i	2.8	142	11.95–09.00	M52 B28/M52 B28 TU	6	ZS 302	
530 i	3.0	170	09.00–09.02	M54 B30 /M54 306 S3	6	ZS 302	
530 i	3.0	170	10.02–06.03	M54 B30 /M54 306 S3	6	ZS 324	
535 i	3.5	173	04.96–03.99	M62 B(35 8 S1)/M62 B35	8	ZS 302	
535 i	3.5	180	04.99–06.03	M62 B(35 8 S2)/M62 B35 TU	8	ZS 302	
540 i	4.4	210	04.96–06.03	M62 B44/M62 B44 TU/M62 448 S2	8	ZS 302	
M 4.9	4.9	294	10.98–06.03	S38 B49	8	ZS 302	

**5 (E60)**

520 i	2.2	125	07.03–06.09	M54 B22 , M54 226 S1	6	ZS 324	
520 i	2.0	125	09.07–03.10	N43 B20 A	4	ZSE 144	
523 i	2.5	130	07.05–04.06	N52 B25/N52 B25 A	6	ZSE 145	
523 i	2.5	130	11.07–03.10	N52 B25/N52 B25 A	6	ZSE 143	
523 i	2.5	140	01.07–03.10	N52 B25 A	6	ZSE 143 <sup>202</sup>	
523 i	2.5	140	01.07–03.10	N52 B25 A	6	ZSE 144 <sup>202</sup>	
525 i	2.5	141	09.03–06.09	M54 256 S5 , M54 B25	6	ZS 324	
525 i	2.5	160	07.05–04.06	N52 B25/N52 B25 A	6	ZSE 145	
525 i	2.5	160	11.07–03.10	N52 B25/N52 B25 A	6	ZSE 143	
525 i	3.0	160	01.07–03.10	N53 B30/N53 B30 A	6	ZSE 144	
525 i xDrive	3.0	160	09.08–03.10	N53 B30 A	6	ZSE 144	
525 xi	2.5	160	07.05–04.06	N52 B25 A	6	ZSE 145	
525 xi	3.0	160	01.07–08.08	N53 B30 A	6	ZSE 144	
530 i	3.0	170	07.03–06.09	M54 306 S3 , M54 B30	6	ZS 324	
530 i	3.0	190	07.05–04.06	N52 B30 A/N52 B30	6	ZSE 145	
530 i	3.0	190	11.07–03.10	N52 B30 A/N52 B30	6	ZSE 143	
530 i	3.0	200	01.07–03.10	N53 B30/N53 B30 A	6	ZSE 144	
530 i xDrive	3.0	200	09.08–03.10	N53 B30 A	6	ZSE 144	
530 xi	3.0	190	07.05–04.06	N52 B30 A	6	ZSE 145	
530 xi	3.0	190	11.07–08.08	N52 B30 A	6	ZSE 143	
530 xi	3.0	200	01.07–08.08	N53 B30 A	6	ZSE 144	
540 i	4.0	225	07.05–06.09	N62 B40 A	8	ZS 324	
545 i	4.4	245	09.03–06.09	N62 B44	8	ZS 324	
550 i	4.8	270	07.05–06.09	N62 B48 B	8	ZS 324	

**5 (F10)**

523 i	3.0	150	03.10–08.11	N53 B30 A	6	ZSE 144	
528 i	3.0	190	03.10–08.11	N53 B30 A	6	ZSE 143 <sup>202</sup>	
528 i	3.0	190	03.10–08.11	N53 B30 A	6	ZSE 144 <sup>202</sup>	
530 i	3.0	200	09.11–02.12	N53 B30 A	6	ZSE 144	
550 i	4.4	300	03.10–	N63 B44 A	8	ZSE 143	
550 i xDrive	4.4	300	09.10–	N63 B44 A	8	ZSE 143	

**5 GRAN TURISMO (F07)**

550 i	4.4	300	10.09–06.12	N63 B44 A	8	ZSE 143	
550 i xDrive	4.4	300	09.10–06.12	N63 B44 A	8	ZSE 143	

**5 Touring (E34)**

518 g	1.8	85	11.95–06.96	M43 B18	4	ZS 307	
518 i	1.8	83	03.93–09.94	M40 B18	4	ZS 122	
518 i	1.8	85	09.94–01.97	M43 B18	4	ZS 307	
520 i	2.0	110	11.91–12.96	M50 B(20 6 S2) Vanos/M50 B20/ M50 B(20 6 S1)/M50 B20 TU	6	ZS 014	ZLE 232
525 i	2.5	141	11.91–12.96	M50 B25/M50 B25 TU	6	ZS 014	ZLE 232
525 ix	2.5	141	02.92–12.96	M50 B25/M52 B25 (Vanos)	6	ZS 014	ZLE 232



kW

**BMW****5 Touring (E34)**

530 i V8	3.0	160	09.92–12.96	M60 B30	8		ZS 014	ZLE 232
540 i	4.0	210	09.93–12.96	M60 B40	8		ZS 014	ZLE 232

**5 Touring (E39)**

520 i	2.0	110	01.97–09.00	M52 B(20 6 S3) Vanos/M52 B(20 6 S4)/M52 B20	6		ZS 302	
520 i	2.2	125	10.02–05.04	M54 B22	6		ZS 324	
520 i	2.2	125	09.00–09.02	M54 B22	6		ZS 302	
523 i	2.5	125	01.97–09.00	M52 B25 TU/M52 B25 (Vanos)	6		ZS 302	
525 i	2.5	141	09.00–09.02	M54 256 S5/M54 B25	6		ZS 302	
528 i	2.8	142	01.97–09.00	M52 B28/M52 B28 TU	6		ZS 302	
530 i	3.0	170	09.00–09.02	M54 B30 /M54 306 S3	6		ZS 302	
530 i	3.0	170	10.02–05.04	M54 B30 /M54 306 S3	6		ZS 324	
540 i	4.4	210	01.97–05.04	M62 B44/M62 B44 TU/M62 448 S2	8		ZS 302	

**5 Touring (E61)**

520 i	2.0	125	09.07–08.10	N43 B20 A	4		ZSE 144	
523 i	2.5	130	07.05–04.06	N52 B25/N52 B25 A	6		ZSE 145	
523 i	2.5	130	11.07–08.10	N52 B25/N52 B25 A	6		ZSE 143	
523 i	2.5	140	01.07–08.10	N52 B25 A	6		ZSE 144	
525 i	2.5	141	06.04–06.09	M54 256 S5/M54 B25	6		ZS 324	
525 i	2.5	160	07.05–04.06	N52 B25/N52 B25 A	6		ZSE 145	
525 i	2.5	160	11.07–08.10	N52 B25/N52 B25 A	6		ZSE 143	
525 i	3.0	160	01.07–08.10	N53 B30/N53 B30 A	6		ZSE 144	
525 i xDrive	3.0	160	09.08–08.10	N53 B30 A	6		ZSE 144	
525 xi	2.5	160	07.05–04.06	N52 B25 A	6		ZSE 145	
525 xi	3.0	160	01.07–08.08	N53 B30 A	6		ZSE 144	
530 i	3.0	190	07.05–04.06	N52 B30 A/N52 B30	6		ZSE 145	
530 i	3.0	190	11.07–08.10	N52 B30 A/N52 B30	6		ZSE 143	
530 i	3.0	200	01.07–08.10	N53 B30 A	6		ZSE 143 <sup>202</sup>	
530 i	3.0	200	01.07–08.10	N53 B30 A	6		ZSE 144 <sup>202</sup>	
530 i xDrive	3.0	200	09.08–08.10	N53 B30 A	6		ZSE 144	
530 xi	3.0	190	11.07–08.08	N52 B30 A	6		ZSE 143	
530 xi	3.0	200	01.07–08.08	N53 B30 A	6		ZSE 144	
545 i	4.4	245	06.04–06.09	N62 B44	8		ZS 324	
550 i	4.8	270	07.05–06.09	N62 B48 A/N62 B48 B	8		ZS 324	

**5 Touring (F11)**

523 i	3.0	150	09.10–08.11	N53 B30 A	6		ZSE 144	
528 i	3.0	190	09.10–08.11	N53 B30 A	6		ZSE 143	
528 i	3.0	190	09.10–08.11	N53 B30 A	6		ZSE 144	
530 i	3.0	200	09.11–02.12	N53 B30 A	6		ZSE 144	
550 i	4.4	300	03.11–	N63 B44 A	8		ZSE 143	

**6 (E24)**

628 CSi	2.8	135	05.82–08.87	M30 B28	6	ZM 001		
635 CSi	3.4	136	01.85–05.89	M30 B35 (Motronic,8:1,Kat.)	6		ZS 122	
635 CSi	3.4	141	04.85–09.90	M30 B35	6		ZS 122	
635 CSi	3.4	155	08.87–05.89	M30 B35	6		ZS 122	
635 CSi	3.5	160	06.78–08.88	M30 B35 (Motronic,9.3:1)/M30 B35 (Motronic,10:1)/M30 B35 (L-Jetronic,10:1)	6		ZS 400	
635 CSi	3.5	160	09.84–08.88	M30 B35 (Motronic,9.3:1)/M30 B35 (Motronic,10:1)/M30 B35 (L-Jetronic,10:1)	6		ZS 122	
M 635 CSi	3.5	191	10.86–10.88	S38 B35 (Kat)	6		ZS 122	
M 635 CSi	3.5	211	03.84–05.89	S38 B35	6		ZS 122	

**6 (E63)**

630 i	3.0	190	09.04–04.06	N52 B30 A/N52 B30	6		ZSE 145	
630 i	3.0	190	11.07–07.10	N52 B30 A/N52 B30	6		ZSE 143	
630 i	3.0	200	07.07–07.10	N53 B30	6		ZSE 144	
645 Ci	4.4	245	01.04–06.09	N62 B44/N62 B44 A	8		ZS 324	
650 i	4.8	270	07.05–06.09	N62 B48 B	8		ZS 324	

**6 Cabriolet (E64)**

630 i	3.0	190	09.04–04.06	N52 B30 A/N52 B30	6		ZSE 145	
630 i	3.0	190	11.07–07.10	N52 B30 A/N52 B30	6		ZSE 143	
630 i	3.0	200	07.07–07.10	N53 B30	6		ZSE 144	
645 Ci	4.4	245	04.04–06.09	N62 B44/N62 B44 A	8		ZS 324	

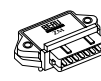

kW

**BMW****6 Cabriolet (E64)**

650 i	4.8	270	07.05–06.09	N62 B48 B	8		<b>ZS 324</b>	
-------	-----	-----	-------------	-----------	---	--	---------------	--

**6 Cabriolet (F12)**

650 i	4.4	300	03.11–06.12	N63 B44 A	8		<b>ZSE 143</b>	
-------	-----	-----	-------------	-----------	---	--	----------------	--

650 i xDrive	4.4	300	10.11–06.12	N63 B44 A	8		<b>ZSE 143</b>	
--------------	-----	-----	-------------	-----------	---	--	----------------	--

**6 Coupe (F13)**

650 i	4.4	300	10.11–06.12	N63 B44 A	8		<b>ZSE 143</b>	
-------	-----	-----	-------------	-----------	---	--	----------------	--

650 i xDrive	4.4	300	10.11–06.12	N63 B44 A	8		<b>ZSE 143</b>	
--------------	-----	-----	-------------	-----------	---	--	----------------	--

**7 (E23)**

728 i	2.8	135	06.81–08.86	M30 B28	6	<b>ZM 001</b>		
-------	-----	-----	-------------	---------	---	---------------	--	--

735 i	3.4	136	01.85–08.86	M30 B35 (Motronic,8:1,Kat.)	6		<b>ZS 122</b>	
-------	-----	-----	-------------	-----------------------------	---	--	---------------	--

735 i	3.4	141	04.85–08.86	M30 B35 (Motronic)	6		<b>ZS 122</b>	
-------	-----	-----	-------------	--------------------	---	--	---------------	--

735 i	3.5	160	09.79–08.86	M30 B35 (Motronic,9.3:1)/ M30 B35 (Motronic,10:1)	6		<b>ZS 122</b>	
-------	-----	-----	-------------	--	---	--	---------------	--

745 i	3.4	185	05.83–08.86	M30 B35	6		<b>ZS 122</b>	
-------	-----	-----	-------------	---------	---	--	---------------	--

**7 (E32)**

730 i,iL	3.0	138	12.86–09.94	M30 B30	6		<b>ZS 122</b>	
----------	-----	-----	-------------	---------	---	--	---------------	--

730 i,iL	3.0	145	12.86–09.94	M30 B30	6		<b>ZS 122</b>	
----------	-----	-----	-------------	---------	---	--	---------------	--

730 i,iL V8	3.0	160	04.92–09.94	M60 B30	8		<b>ZS 014</b>	<b>ZLE 232</b>
-------------	-----	-----	-------------	---------	---	--	---------------	----------------

735 i,iL	3.4	155	09.86–09.92	M30 B35	6		<b>ZS 122</b>	
----------	-----	-----	-------------	---------	---	--	---------------	--

735 i,iL	3.4	162	09.86–12.87	M30 B35 (Motronic,9.2:1)	6		<b>ZS 122</b>	
----------	-----	-----	-------------	--------------------------	---	--	---------------	--

740 i,iL V8	4.0	210	04.92–09.94	M60 B40	8		<b>ZS 014</b>	<b>ZLE 232</b>
-------------	-----	-----	-------------	---------	---	--	---------------	----------------

**7 (E38)**

728 i,iL	2.8	142	08.95–11.01	M52 B28/M52 B28 TU	6		<b>ZS 302</b>	
----------	-----	-----	-------------	--------------------	---	--	---------------	--

730 i,iL	3.0	155	10.94–12.96	M60 B30	8		<b>ZS 014</b>	<b>ZLE 232</b>
----------	-----	-----	-------------	---------	---	--	---------------	----------------

730 i,iL	3.0	160	10.94–12.96	M60 B30	8		<b>ZS 014</b>	<b>ZLE 232</b>
----------	-----	-----	-------------	---------	---	--	---------------	----------------

735 i,iL	3.5	173	01.96–11.01	M62 B(35 8 S1)/M62 B35	8		<b>ZS 302</b>	
----------	-----	-----	-------------	------------------------	---	--	---------------	--

740 i,iL	4.0	210	10.94–06.96	M60 B40	8		<b>ZS 014</b>	<b>ZLE 232</b>
----------	-----	-----	-------------	---------	---	--	---------------	----------------

740 i,iL	4.4	210	01.96–11.01	M62 B44/M62 B44 TU/M62 448 S2	8		<b>ZS 302</b>	
----------	-----	-----	-------------	-------------------------------	---	--	---------------	--

750 i,iL	5.4	240	12.94–11.01	M73 B54	12		<b>ZS 302</b>	
----------	-----	-----	-------------	---------	----	--	---------------	--

**7 (E65, E66)**

730 i,Li	3.0	170	03.03–06.09	M54 B30 /M54 306 S3	6		<b>ZS 324</b>	
----------	-----	-----	-------------	---------------------	---	--	---------------	--

730 i,Li	3.0	190	03.05–04.06	N52 B30 A/N52 B30	6		<b>ZSE 145</b>	
----------	-----	-----	-------------	-------------------	---	--	----------------	--

730 i,Li	3.0	190	11.07–10.08	N52 B30 A/N52 B30	6		<b>ZSE 143</b>	
----------	-----	-----	-------------	-------------------	---	--	----------------	--

735 i,Li	3.6	200	11.01–06.09	N62 B36	8		<b>ZS 324</b>	
----------	-----	-----	-------------	---------	---	--	---------------	--

740 i,Li	4.0	225	07.05–06.09	N62 B40 A	8		<b>ZS 324</b>	
----------	-----	-----	-------------	-----------	---	--	---------------	--

745 i,Li	4.4	245	11.01–06.09	N62 B44/N62 B44 A	8		<b>ZS 324</b>	
----------	-----	-----	-------------	-------------------	---	--	---------------	--

750 i,Li	4.8	270	07.05–06.09	N62 B48 B	8		<b>ZS 324</b>	
----------	-----	-----	-------------	-----------	---	--	---------------	--

760 i,Li	6.0	327	01.03–06.09	N73 B60	12		<b>ZS 324</b>	
----------	-----	-----	-------------	---------	----	--	---------------	--

**7 (F01, F02, F03, F04)**

730 i	3.0	190	05.09–	N52 B30 A/N52 B30 BF	6		<b>ZSE 143</b>	
-------	-----	-----	--------	----------------------	---	--	----------------	--

740 i	3.0	240	10.08–06.12	N54 B30 A	6		<b>ZSE 143</b>	
-------	-----	-----	-------------	-----------	---	--	----------------	--

750 i	4.4	300	10.08–06.12	N63 B44 A	8		<b>ZSE 143</b>	
-------	-----	-----	-------------	-----------	---	--	----------------	--

750 i xDrive	4.4	300	09.09–06.12	N63 B44 A	8		<b>ZSE 143</b>	
--------------	-----	-----	-------------	-----------	---	--	----------------	--

760 i	6.0	400	09.09–	N74 B60 A	12		<b>ZSE 143</b>	
-------	-----	-----	--------	-----------	----	--	----------------	--

ActiveHybrid	4.4	330	10.10–06.12	N63 B44 A	8		<b>ZSE 143</b>	
--------------	-----	-----	-------------	-----------	---	--	----------------	--

ActiveHybrid	4.4	342	10.10–06.12	N63 B44 A	8		<b>ZSE 143</b>	
--------------	-----	-----	-------------	-----------	---	--	----------------	--

**8 (E31)**

840 Ci	4.4	210	01.96–12.99	M62 B44/M62 B44 TU	8		<b>ZS 302</b>	
--------	-----	-----	-------------	--------------------	---	--	---------------	--

840 i	4.0	210	02.93–02.96	M60 B40	8		<b>ZS 014</b>	<b>ZLE 232</b>
-------	-----	-----	-------------	---------	---	--	---------------	----------------

850 Ci	5.4	240	09.94–12.99	M73 B54	12		<b>ZS 302</b>	
--------	-----	-----	-------------	---------	----	--	---------------	--

**X1 (E84)**

xDrive 25 i	3.0	160	01.10–	N52 B30 A	6		<b>ZSE 143</b>	
-------------	-----	-----	--------	-----------	---	--	----------------	--

xDrive 28 i	3.0	190	10.09–08.11	N52 B30 A	6		<b>ZSE 143</b>	
-------------	-----	-----	-------------	-----------	---	--	----------------	--

**X3 (E83)**

2.0 i	2.0	110	07.05–06.09	N46 B20 A , N46 B20	4		<b>ZS 324</b>	
-------	-----	-----	-------------	---------------------	---	--	---------------	--

2.5 i	2.5	141	01.04–06.09	M54 256 S5 , M54 B25	6		<b>ZS 324</b>	
-------	-----	-----	-------------	----------------------	---	--	---------------	--

2.5 si	2.5	160	11.07–08.08	N52 B25 A	6		<b>ZSE 143</b>	
--------	-----	-----	-------------	-----------	---	--	----------------	--

xDrive 25 i	2.5	160	09.08–08.10	N52 B25 A	6		<b>ZSE 143</b>	
-------------	-----	-----	-------------	-----------	---	--	----------------	--

3.0 i	3.0	170	01.04–06.09	M54 306 S3 , M54 B30	6		<b>ZS 324</b>	
-------	-----	-----	-------------	----------------------	---	--	---------------	--

3.0 si	3.0	200	11.07–08.08	N52 B30 A	6		<b>ZSE 143</b>	
--------	-----	-----	-------------	-----------	---	--	----------------	--

xDrive 30 i	3.0	200	09.08–08.10	N52 B30 A	6		<b>ZSE 143</b>	
-------------	-----	-----	-------------	-----------	---	--	----------------	--



kW



BMW							
<b>X3 (F25)</b>							
xDrive 28 i	3.0	190	04.11–03.12	N52 B30 A	6		<b>ZSE 143</b>
<b>X5 (E53)</b>							
3.0 i	3.0	163	05.00–10.02	M54 306 S3	6		<b>ZS 302</b>
3.0 i	3.0	170	10.02–06.09	M54 B30 /M54 306 S3	6		<b>ZS 324</b>
4.4 i	4.4	210	05.00–	M62 B44/M62 B44 TU	8		<b>ZS 302</b>
4.4 i	4.4	235	12.03–06.09	N62 B44 , N62 B44 A	8		<b>ZS 324</b>
4.6 is	4.6	255	02.02–	M67 468 S1/M62 B46	8		<b>ZS 302</b>
4.8 is	4.8	265	04.04–06.09	N62 B48 A	8		<b>ZS 324</b>
<b>X5 (E70)</b>							
3.0 si	3.0	200	11.07–09.08	N52 B30 A/N52 B30	6		<b>ZSE 143</b>
xDrive 30 i	3.0	200	09.08–03.10	N52 B30 A	6		<b>ZSE 143</b>
xDrive 50 i	4.4	300	06.10–	N63 B44 A	8		<b>ZSE 143</b>
M	4.4	408	09.09–	S63 B44 A	8		<b>ZSE 143</b>
4.8 i	4.8	261	02.07–09.08	N62 B48 B	8		<b>ZS 324</b>
<b>X6 (E71, E72)</b>							
35 i	3.0	225	05.08–03.10	N54 B30 A	6		<b>ZSE 143</b>
50 i	4.4	300	05.08–	N63 B44 A	8		<b>ZSE 143</b>
ActiveHybrid	4.4	357	10.10–10.11	N63 B44 A	8		<b>ZSE 143</b>
M	4.4	408	09.09–	S63 B44 A	8		<b>ZSE 143</b>
xDrive 35 i	3.0	225	09.08–03.10	N55 B30 A/N54 B30 A	6		<b>ZSE 143</b>
xDrive 35 i	3.0	225	09.08–	N54 B30 A	6		<b>ZSE 143</b>
xDrive 50 i	4.4	300	09.08–	N63 B44 A	8		<b>ZSE 143</b>
<b>Z1</b>							
2.5	2.5	125	06.88–06.91	M20 B25	6		<b>ZS 122</b>
<b>Z3 (E36)</b>							
1.8	1.8	85	10.95–10.98	M43 B18	4		<b>ZS 307</b>
1.9	1.9	87	07.98–01.03	M43 B19/M43 B19 TU/M43 194 E1	4		<b>ZS 307</b>
1.9	1.9	103	10.95–03.99	M44 B19	4		<b>ZS 307</b>
2.0	2.0	110	04.99–01.03	M52 B(20 6 S4)/M52 B20	6		<b>ZS 302</b>
2.2	2.2	125	08.00–09.02	M54 226 S1/M54 B22	6		<b>ZS 302</b>
2.8	2.8	141	04.97–06.00	M52 B28/M52 B28 TU	6		<b>ZS 302</b>
3.0	3.0	170	06.00–12.02	M54 B30 /M54 306 S3	6		<b>ZS 302</b>
M 3.2	3.2	236	03.97–12.00	S50 B32	6		<b>ZS 302</b>
M 3.2	3.2	239	06.01–01.03	S54 B32 (32 6 S4) , S54 B32	6		<b>ZS 324</b>
<b>Z3 Coupe (E36)</b>							
2.8	2.8	141	07.97–06.00	M52 B28	6		<b>ZS 302</b>
3.0	3.0	170	06.00–12.02	M54 306 S3	6		<b>ZS 302</b>
M	3.2	236	02.98–12.00	S50 B32	6		<b>ZS 302</b>
M	3.2	239	06.01–06.03	S54 326 S4 , S54 B32	6		<b>ZS 324</b>
<b>Z4 (E85)</b>							
2.0 i	2.0	110	04.05–06.09	N46 B20 A , N46 B20	4		<b>ZS 324</b>
2.2 i	2.2	125	10.03–06.09	M54 B22 , M54 226 S1	6		<b>ZS 324</b>
2.5 i	2.5	130	01.06–04.06	N52 B25 A	6		<b>ZSE 145</b>
2.5 i	2.5	130	11.07–02.09	N52 B25 A	6		<b>ZSE 143</b>
2.5 i	2.5	141	02.03–06.09	M54 256 S5 , M54 B25	6		<b>ZS 324</b>
2.5 si	2.5	160	01.06–04.06	N52 B25 A	6		<b>ZSE 145</b>
2.5 si	2.5	160	11.07–03.09	N52 B25 A	6		<b>ZSE 143</b>
3.0 i	3.0	170	02.03–06.09	M54 B30 /M54 306 S3	6		<b>ZS 324</b>
3.0 si	3.0	195	01.06–04.06	N52 B30 A/N52 B30	6		<b>ZSE 145</b>
3.0 si	3.0	195	11.07–08.08	N52 B30 A/N52 B30	6		<b>ZSE 143</b>
M	3.2	252	03.06–06.09	S54 326 S4 , S54 B32	6		<b>ZS 324</b>
<b>Z4 (E89)</b>							
sDrive 23 i	2.5	150	05.09–08.11	N52 B25 A	6		<b>ZSE 143</b>
sDrive 30 i	3.0	190	05.09–08.11	N52 B30 A	6		<b>ZSE 143</b>
sDrive 35 i	3.0	225	05.09–	N54 B30 A	6		<b>ZSE 143</b>
sDrive 35 is	3.0	250	09.10–	N54 B30 A	6		<b>ZSE 143</b>
<b>Z4 Coupe (E86)</b>							
3.0 si	3.0	195	03.06–04.06	N52 B30 A/N52 B30	6		<b>ZSE 145</b>
3.0 si	3.0	195	11.07–08.08	N52 B30 A/N52 B30	6		<b>ZSE 143</b>
M	3.2	252	03.06–06.09	S54 326 S4 , S54 B32	6		<b>ZS 324</b>





kW



**BMW**

**Z8 (E52)**

4.9	4.9	294	06.00–06.03	S62 B50/S38 B49	8		<b>ZS 302</b>
-----	-----	-----	-------------	-----------------	---	--	---------------

**BUICK**

**EXCELLE**

1.8	1.8	88	06.06–		4		<b>ZS 508</b>
-----	-----	----	--------	--	---	--	---------------

**CADILLAC**

**CTS**

3.2	3.2	160	09.02–08.04	LA3	6		<b>ZSE 152<sup>291</sup></b>
-----	-----	-----	-------------	-----	---	--	------------------------------

3.2	3.2	160	09.02–08.04	LA3	6		<b>ZSE 153<sup>292</sup></b>
-----	-----	-----	-------------	-----	---	--	------------------------------

**CHEVROLET**

**LACETTI**

1.8	1.8	89	08.05–	F18D3	4		<b>ZS 508</b>
-----	-----	----	--------	-------	---	--	---------------

1.8	1.8	90	03.05–	T18SED	4		<b>ZS 508</b>
-----	-----	----	--------	--------	---	--	---------------

**NEON II**

2.0 16V	2.0	98	08.99–12.06	420H	4		<b>ZS 379</b>
---------	-----	----	-------------	------	---	--	---------------

**NIVA**

1.7 4x4	1.7	59	09.02–		4		<b>ZS 395</b>
---------	-----	----	--------	--	---	--	---------------

**NUBIRA Kombi**

1.8	1.8	89	08.05–	F18D3	4		<b>ZS 508</b>
-----	-----	----	--------	-------	---	--	---------------

1.8	1.8	90	03.05–	T18SED	4		<b>ZS 508</b>
-----	-----	----	--------	--------	---	--	---------------

**NUBIRA Stufenheck**

1.8	1.8	89	01.06–	F18D3	4		<b>ZS 508</b>
-----	-----	----	--------	-------	---	--	---------------

1.8	1.8	90	03.05–	T18SED	4		<b>ZS 508</b>
-----	-----	----	--------	--------	---	--	---------------

**OPTRA**

1.8	1.8	85	08.03–		4		<b>ZS 508</b>
-----	-----	----	--------	--	---	--	---------------

1.8	1.8	90	08.03–12.08	T18SED	4		<b>ZS 508</b>
-----	-----	----	-------------	--------	---	--	---------------

**TRAILBLAZER**

4.2 AWD	4.2	201	01.06–09.08	LL8	6		<b>ZSE 133</b>
---------	-----	-----	-------------	-----	---	--	----------------

4.2 AWD	4.2	217	01.06–09.08	LL8	6		<b>ZSE 133</b>
---------	-----	-----	-------------	-----	---	--	----------------

**CHRYSLER**

**300 C**

2.7	2.7	130	01.07–11.12	EES	6		<b>ZS 431</b>
-----	-----	-----	-------------	-----	---	--	---------------

2.7	2.7	142	09.04–11.12	2.7FX , EER	6		<b>ZS 431</b>
-----	-----	-----	-------------	-------------	---	--	---------------

3.5	3.5	183	09.04–11.12	3.5CSP	6		<b>ZS 432</b>
-----	-----	-----	-------------	--------	---	--	---------------

**300 C Touring**

2.7	2.7	130	01.07–12.10	EES	6		<b>ZS 431</b>
-----	-----	-----	-------------	-----	---	--	---------------

2.7	2.7	142	09.04–12.10	2.7FX , EER	6		<b>ZS 431</b>
-----	-----	-----	-------------	-------------	---	--	---------------

3.5	3.5	183	09.04–12.10	3.5CSP	6		<b>ZS 432</b>
-----	-----	-----	-------------	--------	---	--	---------------

3.5 AWD	3.5	183	09.04–12.10	3.5CSP	6		<b>ZS 432</b>
---------	-----	-----	-------------	--------	---	--	---------------

**300 M**

2.7 V6 24V	2.7	149	11.98–08.00	EER	6		<b>ZS 431</b>
------------	-----	-----	-------------	-----	---	--	---------------

2.7 V6 24V	2.7	150	08.00–09.04	EER	6		<b>ZS 431</b>
------------	-----	-----	-------------	-----	---	--	---------------

3.5 V6 24V	3.5	185	08.00–09.04	EGG	6		<b>ZS 432</b>
------------	-----	-----	-------------	-----	---	--	---------------

3.5 V6 24V	3.5	187	07.98–08.00	EGG	6		<b>ZS 432</b>
------------	-----	-----	-------------	-----	---	--	---------------

**CIRRUS**

2.0 LX	2.0	96	05.94–09.97	ECB	4		<b>ZS 379</b>
--------	-----	----	-------------	-----	---	--	---------------

2.0 LX	2.0	98	10.97–09.00	ECB	4		<b>ZS 379</b>
--------	-----	----	-------------	-----	---	--	---------------

**CONCORDE**

2.7 LX	2.7	149	10.97–09.03	EER	6		<b>ZS 431</b>
--------	-----	-----	-------------	-----	---	--	---------------

3.3 LX	3.3	120	10.92–09.97	EGB	6		<b>ZS 406</b>
--------	-----	-----	-------------	-----	---	--	---------------

3.5 LX	3.5	174	10.97–09.03	EWZ	6		<b>ZS 432</b>
--------	-----	-----	-------------	-----	---	--	---------------

3.5 LX Supercharged	3.5	186	10.97–09.03	EWZ	6		<b>ZS 432</b>
---------------------	-----	-----	-------------	-----	---	--	---------------

**NEON**

2.0 16V	2.0	98	05.94–08.99	420H	4		<b>ZS 379</b>
---------	-----	----	-------------	------	---	--	---------------

2.0 16V	2.0	107	06.94–08.99	ECC	4		<b>ZS 379</b>
---------	-----	-----	-------------	-----	---	--	---------------

2.0 16V	2.0	109	04.96–08.99	420T	4		<b>ZS 379</b>
---------	-----	-----	-------------	------	---	--	---------------



kW

**CHRYSLER**

<b>CHRYSLER</b>							
<b>NEON II</b>							
1.6	1.6	85	11.01–12.06	EJD	4		<b>ZS 392</b>
<b>NEW YORKER</b>							
3.5 i 24V	3.5	155	04.93–09.98	F01	6		<b>ZS 406</b>
<b>PACIFICA</b>							
3.5 AWD	3.5	186	08.03–09.08	EGN	6		<b>ZS 432</b>
<b>PT CRUISER</b>							
1.6	1.6	85	11.01–12.10	EJD	4		<b>ZS 392</b>
2.0	2.0	104	06.00–12.10	ECC	4		<b>ZS 380</b>
2.4	2.4	105	08.05–12.10	EDZ	4		<b>ZS 380</b>
2.4	2.4	110	06.00–12.10	EDZ	4		<b>ZS 380</b>
<b>PT CRUISER Cabriolet</b>							
2.4	2.4	105	03.04–03.08	EDZ	4		<b>ZS 380</b>
<b>SEBRING</b>							
2.0	2.0	104	04.01–06.07	ECC	4		<b>ZS 380</b>
2.7 V6 24V	2.7	149	04.01–06.07	EES	6		<b>ZS 431</b>
<b>SEBRING Cabriolet</b>							
2.7 V6 24V	2.7	149	04.01–	EES	6		<b>ZS 431</b>
<b>STRATUS</b>							
2.0 16V	2.0	98	12.95–	ECB	4		<b>ZS 379</b>
2.0 LE	2.0	96	12.95–04.01	C00	4		<b>ZS 380</b>
2.4 16V	2.4	112	12.95–	EDZ	4		<b>ZS 379</b>
<b>STRATUS Cabriolet</b>							
2.0 LE	2.0	96	06.96–04.01	420X	4		<b>ZS 380</b>
<b>VOYAGER I</b>							
3.3	3.3	112	10.89–09.90	EGA	6		<b>ZS 405</b>
<b>VOYAGER II</b>							
3.3 i	3.3	110	08.90–09.95	EGA	6		<b>ZS 405</b>
3.3 i	3.3	120	08.90–09.95	EGA	6		<b>ZS 405</b>
3.3 i AWD	3.3	110	08.90–09.95	EGA	6		<b>ZS 405</b>
3.3 i AWD	3.3	120	08.90–09.95	R00	6		<b>ZS 405</b>
<b>VOYAGER III</b>							
2.0 i	2.0	98	01.95–03.01	C00	4		<b>ZS 380</b>
2.4 i	2.4	111	01.95–03.01	B00	4		<b>ZS 380</b>
3.3 i	3.3	116	01.95–03.01	R00	6		<b>ZS 405</b>
<b>VOYAGER IV</b>							
2.4	2.4	108	02.00–12.08	EDZ	4		<b>ZS 380</b>
3.3	3.3	128	02.00–12.08	EGA	6		<b>ZS 405</b>
3.3 AWD	3.3	128	02.00–12.08	EGA	6		<b>ZS 405</b>

**CITROËN**

<b>CITROËN</b>							
<b>AX</b>							
10 E	1.0	30	12.86–12.88	C3A	4	<b>ZM 003</b>	<b>ZS 247</b>
10	1.0	32	09.86–06.92	C1A	4	<b>ZM 003</b>	<b>ZS 247</b>
10	1.0	33	07.86–12.90	CDY (TU9M)	4		<b>ZS 247</b>
10	1.0	33	07.86–12.98	CDY (TU9M)	4	<b>ZM 003</b> <sup>283,285</sup>	
10	1.0	33	01.92–12.98	CDY (TU9M)	4	<b>ZM 001</b>	<b>ZS 231</b>
10	1.0	33	01.91–12.98	CDY (TU9M)	4		<b>ZS 249</b>
10	1.0	37	01.93–12.98	CDZ (TU9M)	4		<b>ZS 231</b>
11	1.1	40	12.86–04.94	H1A/H1B	4	<b>ZM 003</b> <sup>283,285</sup>	<b>ZS 247</b>
11 4x4	1.1	40	06.91–07.92	H1A	4	<b>ZM 003</b> <sup>283,285</sup>	<b>ZS 247</b>
11 KAT	1.1	40	09.88–12.89	HAZ (TU1CP)	4	<b>ZM 003</b> <sup>283,285</sup>	<b>ZS 247</b>
11	1.1	44	09.86–12.90	HDZ (TU1M)/H1B	4	<b>ZM 003</b>	<b>ZS 247</b>
11	1.1	44	01.91–12.97	HDZ (TU1M)/H1B Mot.Nr.→5656	4		<b>ZS 249</b>
11	1.1	44	01.91–12.97	HDZ (TU1M)/H1B Mot.Nr.5657→	4		<b>ZS 231</b>
1.3 Sport	1.3	70	04.87–12.88	M4A	4	<b>ZM 003</b>	<b>ZS 247</b>
14	1.4	44	12.86–12.88	KAY (TU3CP)	4	<b>ZM 003</b>	<b>ZS 247</b>
14	1.4	49	06.88–12.89	K1F	4	<b>ZM 003</b>	
14	1.4	55	04.87–04.97	KDY (TU3FM)/KDZ (TU3M/Z)/ KDX (TU3M/Z)/KDY (TU3M)	4	<b>ZM 001</b>	<b>ZS 247</b>



kW

**CITROËN**

<b>AX</b>							
14	1.4	55	04.87–04.97	KDY (TU3FM)/KDZ (TU3M/Z)/ KDX (TU3M/Z)/KDY (TU3M)	4	ZM 003 <sup>283,285</sup>	ZS 247
14 4x4	1.4	55	08.91–12.96	KDY (TU3FM)/KDZ (TU3M/Z)/ KDX (TU3M/Z)/KDY (TU3M)	4		ZS 247
14	1.4	62	01.88–12.90	K2B/K2A	4		ZS 247
14	1.4	62	01.88–12.92	K2B/K2A	4	ZM 003	
1.4 GTi	1.4	66	01.92–12.96	KFY (TU3FJ2)	4		ZS 231
1.4 GTi	1.4	69	01.92–12.96	KFZ (TU3FJ2)	4	ZM 026	ZS 231
<b>BERLINGO</b>							
1.1 i	1.1	44	07.96–	HDZ (TU1M)/HFX (TU1JP)	4	ZM 026	ZS 341
1.1 i	1.1	44	01.01–	HDZ (TU1M)/HFX (TU1JP)	4	ZM 026	ZSE 047
1.4	1.4	55	03.09–03.10	KFW (TU3JP)	4		ZSE 047
1.4 i	1.4	55	07.96–	KFX (TU3JP)/KFW (TU3JP)	4	ZM 003	ZS 341
1.4 i	1.4	55	06.98–11.02	KFX (TU3JP)	4	ZM 003	ZS 381
1.6	1.6	66	04.08–	NFR (TU5JP4B)	4		ZSE 045
1.6	1.6	80	04.08–	NFU (TU5JP4)	4		ZSE 045
1.6 16V	1.6	80	10.00–	NFU (TU5JP4)	4		ZSE 045
1.8 i	1.8	66	05.97–	LFX (XU7JB)	4		ZS 341
<b>BX</b>							
14	1.4	55	01.89–02.93	KDZ (TU3M/Z)/KDY (TU3M)	4		ZS 247
14 E	1.4	45	10.82–06.88	150A	4	ZM 003	ZS 106
14 E	1.4	45	10.82–06.88	150A	4	ZM 003	ZS 115
14 E	1.4	49	09.85–02.93	150F	4	ZM 003	ZS 106
14 E	1.4	49	09.85–02.93	150F	4	ZM 003	ZS 115
14 E	1.4	52	04.83–07.89	150C/K1G	4	ZM 003	ZS 106
14 E	1.4	52	04.83–07.89	150C/K1G	4	ZM 003	ZS 115
14 E	1.4	53	04.83–02.93	150C	4	ZM 003	ZS 106
14 E	1.4	53	04.83–02.93	150C	4	ZM 003	ZS 115
16	1.6	53	04.88–02.93	B1E (XU51C)	4	ZM 003	ZS 257
16	1.6	58	09.87–02.93	B1A (XU51C/K)	4		ZS 341
16	1.6	64	07.85–02.93	171D	4	ZM 003	ZS 341
16	1.6	66	10.82–06.88	171B/171A/171C	4	ZM 003	ZS 341
16	1.6	68	10.82–12.92	XU52C	4		ZS 341
16	1.6	76	03.86–02.93	180Z	4		ZS 341
16 E	1.6	65	05.89–02.93	BDY (XU5M)/BDZ (XU5M)	4	ZM 003	ZS 257
16 E	1.6	65	05.89–02.93	BDY (XU5M)/BDZ (XU5M)	4	ZM 003	ZS 341
19	1.9	70	09.86–11.89	D2C (XU92C) Mot.Nr.4579→	4	ZM 003 <sup>283,285</sup>	ZS 257
19	1.9	75	07.86–05.89	159A	4	ZM 001	ZS 341
19 E	1.9	80	06.88–02.93	DDZ (XU9M)	4		
19 E	1.9	80	06.88–02.93	DDZ (XU9M)	4	ZM 003	ZS 341
19 E 4x4	1.9	80	04.90–02.93	D2F Org.Nr.4923→	4		ZS 257
19 E 4x4	1.9	80	04.89–02.93	D2F	4		ZS 341
19 GTi	1.9	88	06.88–02.93	DKZ (XU9JA)	4		ZS 257
19 GTi	1.9	90	07.86–02.93	D6A (XU9J2)	4	ZM 003	ZS 257
19 GTi	1.9	90	04.90–02.93	D6A (XU9J2)	4	ZM 026	ZS 257
19 GTi 16V	1.9	108	03.88–02.93	DFW (XU9J4)	4	ZM 003	
19 GTi 16V	1.9	108	03.88–02.93	DFW (XU9J4)	4		ZS 257
19 GTi 16V	1.9	116	09.87–12.88	D6C (XU9J4)	4	ZM 001	ZS 257
19 GTi 4x4	1.9	88	06.88–02.93	DKZ (XU9JA)	4		ZS 257
<b>BX Break</b>							
1.4	1.4	52	01.87–01.92	150C	4	ZM 003	ZS 106
1.4	1.4	52	01.87–01.92	150C	4	ZM 003	ZS 115
1.6	1.6	53	09.88–06.93	B1E (XU51C)	4	ZM 003	ZS 257
1.6	1.6	64	07.85–12.94	171D	4	ZM 003	ZS 341
1.6	1.6	65	05.89–12.94	BDY (XU5M)/BDZ (XU5M)	4	ZM 003 <sup>283,285</sup>	ZS 257
1.6	1.6	76	03.86–12.94	180Z	4	ZM 003	ZS 341
1.9	1.9	70	12.87–12.89	D2C (XU92C) Mot.Nr.4579→	4		ZS 257
1.9	1.9	75	07.86–12.94	D2A (XU92C)	4	ZM 003	ZS 341
1.9	1.9	80	06.88–12.94	DDZ (XU9M)	4		ZS 341



kW



## CITROËN

CITROËN							
<b>BX Break</b>							
19	1.9	88	06.88–12.94	DKZ (XU9JA)	4	ZM 003 <sup>283,285</sup>	ZS 257
19 4x4	1.9	80	10.90–05.91	DDZ (XU9M)	4		ZS 341
19 KAT	1.9	75	07.86–12.94	DFZ (XU9J1)	4	ZM 001	ZS 247
<b>C2</b>							
1.1	1.1	44	04.05–	HFX (TU1JP)	4		ZSE 045
1.1	1.1	44	09.03–	HFX (TU1JP)	4		ZSE 047
1.4	1.4	54	09.03–	KFV (TU3JP)	4		ZSE 047
1.4	1.4	54	04.05–	KFV (TU3JP)	4		ZSE 048
1.6	1.6	80	09.03–	NFU (TU5JP4)	4		ZSE 045
1.6	1.6	80	09.03–	NFU (TU5JP4)	4		ZSE 047
1.6 VTS	1.6	90	01.05–	NFS (TU5JP4S)	4		ZSE 045
<b>C3</b>							
1.1 i	1.1	44	02.02–	HFX (TU1JP)	4		ZSE 047
1.1 i	1.1	44	11.05–	HFX (TU1JP)	4		ZSE 045
1.4 i	1.4	54	02.02–	KFV (TU3JP)	4		ZSE 047
1.4 i	1.4	54	11.05–	KFV (TU3JP)	4		ZSE 048
1.4 i Bivalent	1.4	54	02.02–	KFV (TU3JP)	4		ZSE 047
1.6 16V	1.6	80	02.02–	NFU (TU5JP4)	4		ZSE 045
<b>C3 II</b>							
1.1	1.1	44	11.09–	HFX (TU1JP)	4		ZSE 048
1.4	1.4	54	11.09–	KFT (TU3A)	4		ZSE 048
1.4 VTi 95	1.4	70	11.09–	8FP (EP3)	4		ZSE 143
1.6 VTi 120	1.6	88	11.09–	5FS (EP6C)	4		ZSE 143
<b>C3 Picasso</b>							
1.4 VTi 95	1.4	70	02.09–	8FS (EP3)/8FP (EP3)	4		ZSE 143
1.6 VTi 120	1.6	88	02.09–	5FS (EP6C)/5FW (EP6)	4		ZSE 143
<b>C3 Pluriel</b>							
1.4	1.4	54	05.03–	KFV (TU3JP)	4		ZSE 047
1.4	1.4	54	09.05–	KFV (TU3JP)	4		ZSE 048
1.6	1.6	80	05.03–	NFU (TU5JP4)	4		ZSE 045
<b>C4</b>							
1.6 16V	1.6	80	11.04–	NFU (TU5JP4)	4		ZSE 045
2.0 16V	2.0	100	11.04–	RFN (EW10J4)	4		ZS 348
2.0 16V	2.0	103	11.04–	RFJ (EW10A)	4		ZS 352
<b>C4 (B7)</b>							
1.4 VTi 95	1.4	70	09.10–	8FP (EP3)	4		ZSE 143
1.6 VTi 120	1.6	88	09.10–	5FS (EP6C)	4		ZSE 143
1.6 VTi 120 LPG	1.6	88	09.11–	5FS (EP6C)	4		ZSE 143
<b>C4 (LC_)</b>							
1.6 VTi 120	1.6	88	07.08–09.10	5FW (EP6)	4		ZSE 143
<b>C4 Coupe (LA_)</b>							
1.6 VTi 120	1.6	88	07.08–07.10	5FW (EP6)	4		ZSE 143
<b>C4 Grand Picasso (UA_)</b>							
1.6 VTi 120	1.6	88	07.08–	5FW (EP6)	4		ZSE 143
<b>C4 Picasso (UD_)</b>							
1.6 VTi 120	1.6	88	07.08–	5FW (EP6)	4		ZSE 143
<b>C5 (DC_)</b>							
1.8 16V	1.7	85	03.01–08.04	6FZ (EW7J4)	4		ZS 348
2.0 16V	2.0	100	03.01–08.04	RFN (EW10J4)	4		ZS 348
3.0 V6	2.9	152	03.01–08.04	XFX (ES9J4S)	6		ZS 347
<b>C5 (RC_)</b>							
1.8 16V	1.7	85	09.04–	6FZ (EW7J4)	4		ZS 348
2.0 16V	2.0	103	09.04–	RFJ (EW10A)	4		ZS 352
3.0 V6	2.9	152	09.04–	XFV (ES9A)/XFX (ES9J4S)	6		ZS 347
<b>C5 (RD_)</b>							
2.0 16V	2.0	103	02.08–	RFJ (EW10A)	4		ZS 352
<b>C5 Break (DE_)</b>							
1.8 16V	1.7	85	06.01–08.04	6FZ (EW7J4)	4		ZS 348
2.0 16V	2.0	100	06.01–08.04	RFN (EW10J4)	4		ZS 348
3.0 V6	2.9	152	06.01–08.04	XFX (ES9J4S)	6		ZS 347



kW

**CITROËN****C5 Break (RE\_)**

1.8 16V	1.7	85	09.04–	6FZ (EW7J4)	4		<b>ZS 348</b>
2.0 16V	2.0	103	09.04–	RFJ (EW10A)	4		<b>ZS 352</b>
3.0 V6	2.9	152	09.04–	XFV (ES9A)	6		<b>ZS 347</b>

**C5 Break (TD\_)**

2.0 16V	2.0	103	02.08–	RFJ (EW10A)	4		<b>ZS 352</b>
2.0 16V BioFlex	2.0	103	02.08–	RFJ (EW10A)	4		<b>ZS 352</b>

**C6**

3.0 V6	2.9	155	12.05–	XFV (ES9A)/XFX (ES9J4S)	6		<b>ZS 347</b>
--------	-----	-----	--------	-------------------------	---	--	---------------

**C8**

2.0	2.0	100	07.02–	RFN (EW10J4)	4		<b>ZS 348</b>
2.2	2.2	116	07.02–	3FZ (EW12J4)	4		<b>ZS 351</b>
3.0 V6	2.9	150	07.02–	XFX (ES9J4S)	6		<b>ZS 347</b>

**CX I**

2000	2.0	78	06.79–08.85	829 A5	4		<b>ZS 106</b>
------	-----	----	-------------	--------	---	--	---------------

**CX I**

2000	2.0	78	06.79–08.85	829 A5	4		<b>ZS 115</b>
------	-----	----	-------------	--------	---	--	---------------

**CX II**

20 RE	2.0	78	08.85–12.92	829 A5	4	<b>ZM 001</b>	
22 TRS	2.2	83	07.85–12.92	J6T A500	4		<b>ZS 106</b>
22 TRS	2.2	83	07.85–12.92	J6T A500	4		<b>ZS 115</b>
25 Tri	2.5	100	08.85–12.92	M25-659	4	<b>ZM 001</b>	

**DS3**

1.4 VTi 95	1.4	70	04.10–	8FP (EP3)	4		<b>ZSE 143</b>
1.6 VTi 120	1.6	88	04.10–	5FS (EP6C)	4		<b>ZSE 143</b>

**DS4**

1.6 VTi 120	1.6	88	04.11–	5FS (EP6C)	4		<b>ZSE 143</b>
-------------	-----	----	--------	------------	---	--	----------------

**EVASION**

1.8	1.8	73	05.97–07.02	LFZ (XU7JP)	4		<b>ZS 341</b>
2.0	2.0	89	06.94–07.02	RFU (XU10J2/C)	4		<b>ZS 341</b>
2.0 16V	2.0	100	05.00–07.02	RFN (EW10J4)	4		<b>ZS 348</b>
2.0 16V	2.0	97	10.98–04.00	RFV (XU10J4R)	4		<b>ZS 349</b>
2.0 Turbo C.T.	2.0	108	06.94–07.02	RGX (XU10J2TE)	4	<b>ZM 026</b>	<b>ZS 341</b>

**GS**

A 1.3	1.3	48	09.79–07.86	G13/625/G13/646	4	<b>ZM 001</b>	<b>ZS 115</b>
-------	-----	----	-------------	-----------------	---	---------------	---------------

**JUMPY**

1.6	1.6	58	10.95–	220 A2.000/1580 SPI	4		<b>ZS 234</b>
2.0	2.0	100	09.00–12.06	RFN (EW10J4)	4		<b>ZS 348</b>
2.0 i 16V	2.0	102	01.04–		4		<b>ZS 348</b>
2.0 i	2.0	103	01.07–	RFH (EW10A)	4		<b>ZS 352</b>

**LNA**

1.1	1.1	37	07.82–04.85	109/5E	4	<b>ZM 001</b>	<b>ZS 106</b>
1.1	1.1	37	07.82–04.85	109/5E	4	<b>ZM 001</b>	<b>ZS 115</b>

**NEMO**

1.4	1.4	54	04.09–	KFT (TU3A)/KFW (TU3A)	4		<b>ZSE 048</b>
-----	-----	----	--------	-----------------------	---	--	----------------

**SAXO**

1.0 X	1.0	33	05.96–11.98	CDZ (TU9M)	4		<b>ZS 341</b>
1.0 X	1.0	37	05.98–06.03	CDZ (TU9M)	4		<b>ZS 341</b>
1.1 X,SX	1.1	40	05.96–05.97	HDZ (TU1M)	4		<b>ZS 341</b>
1.1 X,SX	1.1	40	06.97–05.00	HDZ (TU1M)	4		<b>ZS 381</b>
1.1 X,SX	1.1	40	06.00–12.02	HDZ (TU1M)	4		<b>ZSE 047</b>
1.1 X,SX	1.1	44	05.96–09.03	HDZ (TU1M)	4		<b>ZS 341</b>
1.1 X,SX	1.1	44	09.00–09.03	HDZ (TU1M)/HFX (TU1JP)	4		<b>ZSE 047</b>
1.4 VTS	1.4	55	05.96–06.03	KFX (TU3JP)	4		<b>ZS 341</b>
1.4 VTS	1.4	55	02.98–06.03	KFX (TU3JP)/KFW (TU3JP)	4		<b>ZS 381</b>
1.4 VTS	1.4	55	05.96–06.03	KFX (TU3JP)/KFW (TU3JP)	4		<b>ZSE 047</b>
1.6	1.6	66	02.96–06.03	NFZ (TU5JP) Automatik	4		<b>ZS 341</b>
1.6	1.6	66	06.98–06.03	NFZ (TU5JP)	4		<b>ZS 381</b>
1.6	1.6	74	02.01–04.04	NFT	4		<b>ZSE 047</b>
1.6	1.6	88	02.96–04.04	NFX (TU5JP4)	4		<b>ZS 241</b>
1.6	1.6	88	02.96–04.04	NFX (TU5JP4)	4		<b>ZSE 046</b>



kW



## CITROËN

CITROËN							
<b>SAXO</b>							
1.6 VTL,VTR	1.6	65	05.96–06.03	NFZ (TU5JP)	4		<b>ZS 341</b>
1.6 VTL,VTR	1.6	65	06.98–06.03	NFZ (TU5JP)	4		<b>ZS 381</b>
1.6 VTS	1.6	72	09.00–09.03	NFT	4		<b>ZSE 047</b>
1.6 VTS	1.6	87	06.96–09.03	NFX (TU5JP4)	4		<b>ZS 241</b>
1.6 VTS	1.6	87	06.96–09.03	NFX (TU5JP4)	4		<b>ZSE 046</b>
<b>VISA</b>							
11 E	1.1	35	09.78–06.88	109K	4	<b>ZM 001</b>	
11 E	1.1	37	07.82–03.91	109/5F	4	<b>ZM 001</b>	
11 E	1.1	42	09.78–03.91	109/5	4		<b>ZS 106</b>
14	1.4	44	07.84–03.91	150D (XY7)	4	<b>ZM 001</b>	<b>ZS 106</b>
14	1.4	44	07.84–03.91	150D (XY7)	4	<b>ZM 001</b>	<b>ZS 115</b>
14 GT	1.4	58	03.82–03.91	150B (XY8)	4	<b>ZM 001</b>	<b>ZS 106</b>
14 GT	1.4	58	03.82–03.91	150B (XY8)	4	<b>ZM 001</b>	<b>ZS 115</b>
16 GTI	1.6	76	01.85–06.86	180A (XU5J)	4	<b>ZM 001</b>	<b>ZS 106</b>
16 GTI	1.6	76	01.85–06.86	180A (XU5J)	4	<b>ZM 001</b>	<b>ZS 115</b>
16 GTI	1.6	83	06.86–03.91	B6D	4	<b>ZM 001</b>	
<b>XANTIA (X1)</b>							
1.6 i	1.6	65	03.93–01.98	BFZ (XU5JP)	4		<b>ZS 341</b>
1.8 i	1.8	74	03.93–01.98	LFZ (XU7JP)	4		<b>ZS 341</b>
1.8 i 16V	1.8	81	06.95–01.98	LFY (XU7JP4) Org.Nr.→07608	4		<b>ZS 256</b>
1.8 i 16V	1.8	81	06.95–01.98	LFY (XU7JP4) Org.Nr.07609→	4		<b>ZS 349</b>
2.0 i	2.0	89	03.93–01.98	RFX (XU10J2C)	4		<b>ZS 341</b>
2.0 i 16V	2.0	97	06.95–01.98	RFV (XU10J4R) Org.Nr.→07608	4		<b>ZS 256</b>
2.0 i 16V	2.0	97	06.95–01.98	RFV (XU10J4R)	4		<b>ZS 341</b>
2.0 i 16V	2.0	97	08.97–12.97	RFV (XU10J4R)	4		<b>ZS 349</b>
2.0 i 16V	2.0	110	06.94–01.98	RFT (XU10J4/Z)	4	<b>ZM 026</b>	
2.0 i 16V	2.0	110	06.94–01.98	XU10J4TEZ	4		<b>ZS 323</b>
2.0 i 16V	2.0	110	06.94–01.98	RFT (XU10J4/Z)	4		<b>ZS 341</b>
2.0 i 16V	2.0	112	03.93–01.98	XU10J4TEZ	4		<b>ZS 323</b>
2.0 i 16V	2.0	112	03.93–01.98	RFY (XU10J4/Z)	4	<b>ZM 026</b>	<b>ZS 341</b>
2.0 Turbo	2.0	108	06.95–01.98	RGX (XU10J2TE)	4		<b>ZS 341</b>
3.0 i 24V	2.9	140	01.97–12.97	ES9J4/K	6		<b>ZS 343</b>
<b>XANTIA (X2)</b>							
1.8 i	1.8	66	01.98–04.03	LFX (XU7JB)	4		<b>ZS 341</b>
1.8 i 16V	1.8	81	01.98–04.03	LFY (XU7JP4)	4		<b>ZS 349</b>
2.0 i	2.0	89	01.98–04.03	RFX (XU10J2C)	4		<b>ZS 341</b>
2.0 i 16V	2.0	97	01.98–04.03	RFV (XU10J4R)	4		<b>ZS 349</b>
2.0 Turbo	2.0	108	01.98–04.03	RGX (XU10J2TE)	4		<b>ZS 341</b>
3.0 V6	2.9	140	01.98–04.03	XFZ (ES9J4)	6		<b>ZS 343</b>
<b>XANTIA Break (X1)</b>							
1.8 i	1.8	66	04.97–01.98	LFX (XU7JB)	4		<b>ZS 341</b>
1.8 i	1.8	74	06.95–01.98	LFZ (XU7JP)	4		<b>ZS 341</b>
1.8 i 16V	1.8	81	06.95–01.98	LFY (XU7JP4)	4		<b>ZS 256</b>
1.8 i 16V	1.8	81	06.95–01.98	LFY (XU7JP4) Org.Nr.07609→	4		<b>ZS 349</b>
2.0 i	2.0	89	06.95–01.98	RFX (XU10J2C)	4		<b>ZS 341</b>
2.0 i 16V	2.0	97	06.95–01.98	RFV (XU10J4R) Org.Nr.→7608	4	<b>ZM 026</b>	<b>ZS 256</b>
2.0 i 16V	2.0	97	08.97–01.98	RFV (XU10J4R)	4	<b>ZM 026</b>	<b>ZS 349</b>
2.0 Turbo	2.0	108	06.95–01.98	RGX (XU10J2TE)	4		<b>ZS 341</b>
<b>XANTIA Break (X2)</b>							
1.8 i	1.8	66	01.98–04.03	LFX (XU7JB)	4		<b>ZS 341</b>
1.8 i 16V	1.8	81	01.98–04.03	LFY (XU7JP4)	4		<b>ZS 349</b>
2.0 i	2.0	89	01.98–04.03	RFX (XU10J2C)	4	<b>ZM 026</b>	<b>ZS 341</b>
2.0 i	2.0	89	01.98–05.02	RFX (XU10J2C)	4	<b>ZM 026</b>	<b>ZS 349</b>
2.0 i 16V	2.0	97	01.98–04.03	RFV (XU10J4R)	4		<b>ZS 349</b>
2.0 Turbo	2.0	108	01.98–04.03	RGX (XU10J2TE)	4		<b>ZS 341</b>
3.0 V6	2.9	140	01.98–05.02	ES9J4/L3	6		<b>ZS 343</b>

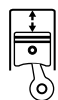

kW

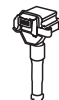

## CITROËN

## XM (Y3)

2.0 i	2.0	89	05.89–06.94	RFZ (XU10J2)	4	ZM 003	ZS 341
2.0 i	2.0	89	10.90–06.94	RFZ (XU10J2)	4	ZM 026	ZS 341
2.0 i Turbo	2.0	104	09.92–06.94	RGY (XU10J2TE/Z)	4		ZS 341
3.0 V6	3.0	123	05.89–06.94	UFZ (ZPJZ)/SFZ (ZPJZ)	6	ZM 015	
3.0 V6 24V	3.0	147	07.90–06.94	UKZ (ZPJ4Z)/SKZ (ZPJ4Z)	6	ZM 015	

## XM (Y4)

2.0 i 16V	2.0	97	05.94–10.00	RFV (XU10J4R)	4		ZS 256
2.0 i 16V	2.0	97	05.94–10.00	RFV (XU10J4R)	4		ZS 341
2.0 i 16V	2.0	97	09.97–10.00	RFV (XU10J4R)	4		ZS 349
2.0 Turbo	2.0	108	05.94–10.00	RGX (XU10J2TE)	4		
2.0 Turbo	2.0	108	05.94–10.00	RGX (XU10J2TE)	4	ZM 026	ZS 341
3.0 V6	2.9	140	04.97–07.97	ES9J4/L3	6		ZS 343

## XM Break (Y3)

2.0 i	2.0	79	11.91–04.94	XU102C	4		ZS 258
2.0 i	2.0	79	11.91–04.94	RDZ (XU10MZ)	4		ZS 341
2.0 i	2.0	89	11.91–04.94	RFZ (XU10J2)	4	ZM 026	ZS 341
2.0 Turbo	2.0	104	09.92–04.94	RGY (XU10J2TE/Z)	4	ZM 026	ZS 341
3.0 V6	3.0	123	11.91–04.94	UFZ (ZPJZ)/SFZ (ZPJZ)	6	ZM 015	

## XM Break (Y4)

2.0 i 16V	2.0	97	05.94–10.00	RFV (XU10J4R)	4		ZS 256
2.0 i 16V	2.0	97	05.94–10.00	RFV (XU10J4R)	4		ZS 341
2.0 i 16V	2.0	97	09.97–10.00	RFV (XU10J4R)	4		ZS 349
2.0 Turbo	2.0	108	05.94–10.00	RGX (XU10J2TE)/RGY (XU10J2TE/Z)	4		ZS 341
3.0 V6	2.9	140	04.97–07.97	ES9J4/L3 Automatik	6		ZS 343

## XSARA

1.4 i	1.4	55	04.97–03.05	KFX (TU3JP)/KFW (TU3JP)	4		ZS 341
1.4 i	1.4	55	04.97–03.05	KFX (TU3JP)	4		ZS 381
1.4 i	1.4	55	04.97–03.05	KFX (TU3JP)/KFW (TU3JP)	4		ZSE 047
1.6 16V	1.6	80	09.00–03.05	NFU (TU5JP4)	4		ZSE 045
1.6 i	1.6	65	04.97–09.00	NFZ (TU5JP)	4		ZS 341
1.6 i	1.6	65	04.97–09.00	NFZ (TU5JP)	4		ZS 381
1.8 i	1.8	66	04.97–09.00	LFX (XU7JB)	4		ZS 341
1.8 i 16V	1.8	81	04.97–09.00	LFY (XU7JP4)	4		ZS 349
1.8 i Aut.	1.8	74	04.97–09.00	LFZ (XU7JP)	4		ZS 341
2.0 16V	2.0	100	09.00–03.05	RFN (EW10J4)	4		ZS 348
2.0 16V	2.0	97	07.98–09.00	RFV (XU10J4R)	4		ZS 349

## XSARA Break

1.4 i	1.4	55	10.97–08.05	KFX (TU3JP)/KFW (TU3JP)	4		ZS 341
1.4 i	1.4	55	10.97–08.05	KFX (TU3JP)	4		ZS 381
1.4 i	1.4	55	10.97–08.05	KFX (TU3JP)/KFW (TU3JP)	4		ZSE 047
1.6 16V	1.6	80	09.00–08.05	NFU (TU5JP4)	4		ZSE 045
1.6 i	1.6	65	10.97–09.00	NFZ (TU5JP)	4		ZS 341
1.6 i	1.6	65	10.97–09.00	NFZ (TU5JP)	4		ZS 381
1.8 i	1.8	66	10.97–09.00	LFX (XU7JB)	4		ZS 341
1.8 i 16V	1.8	81	03.98–09.00	LFY (XU7JP4)	4		ZS 349
1.8 i Aut.	1.8	74	10.97–09.00	LFZ (XU7JP)	4		ZS 341
2.0 16V	2.0	97	07.98–09.00	RFV (XU10J4R)	4		ZS 349
2.0 16V	2.0	100	09.00–08.05	RFN (EW10J4)	4		ZS 348

## XSARA Coupe

1.4 i	1.4	55	03.98–03.05	KFX (TU3JP)/KFW (TU3JP)	4		ZS 341
1.4 i	1.4	55	03.98–03.05	KFX (TU3JP)	4		ZS 381
1.4 i	1.4	55	03.98–03.05	KFX (TU3JP)/KFW (TU3JP)	4		ZSE 047
1.6 i	1.6	65	02.98–06.98	NFZ (TU5JP)	4		ZS 232
1.6 16V	1.6	80	09.00–03.05	NFU (TU5JP4)	4		ZSE 045
1.8 i	1.8	66	02.98–09.00	LFX (XU7JB)	4		ZS 341
1.8 i	1.8	74	02.98–09.00	LFZ (XU7JP)	4		ZS 232
1.8 i 16V	1.8	81	02.98–09.00	LFY (XU7JP4)	4		ZS 349
2.0 16V	2.0	100	09.00–03.05	RFN (EW10J4)	4		ZS 348
2.0 i 16V	2.0	120	02.98–03.05	RFS (XU10J4RS)	4		ZS 346



kW



## CITROËN

## XSARA PICASSO

1.6	1.6	65	12.99–	NFZ (TU5JP)	4		ZS 381
1.6	1.6	70	12.99–	NFV (TU5JP)	4		ZS 381
1.6	1.6	70	12.99–	NFV (TU5JP)	4		ZSE 047
1.6 16V	1.6	80	09.05–	NFU (TU5JP4)	4		ZSE 045
1.8 16V	1.7	85	02.00–	6FZ (EW7J4)	4		ZS 348
2.0 16V	2.0	100	01.03–	RFN (EW10J4)	4		ZS 348
<b>ZX</b>							
1,1	1.1	40	03.91–08.93	H1A/H1B	4	ZM 003	ZS 249
1.1	1.1	44	03.91–06.97	HDZ (TU1M)	4	ZM 003 <sup>283,285</sup>	ZS 249
1.4	1.4	55	03.91–06.97	KDZ (TU3M/Z)	4	ZM 003 <sup>283,285</sup>	ZS 249
1.4 i	1.4	55	03.91–06.97	KDZ (TU3M/Z)/KFX (TU3JP)/KDX (TU3M/Z) Org.Nr.5783→	4	ZM 003	ZS 231
1.4 i	1.4	55	03.91–06.97	KDZ (TU3M/Z)/KFX (TU3JP)/KDX (TU3M/Z)	4	ZM 003 <sup>283,285</sup>	ZS 249
1.6 i	1.6	65	03.91–06.97	BFZ (XU5JP)/BDY (XU5M)	4		ZS 341
1.8	1.8	82	04.96–10.97	LFY (XU7JP4)	4		ZS 256
1.8	1.8	82	04.96–10.97	LFY (XU7JP4) Org.Nr.07609→	4		ZS 349
1.8 i	1.8	74	07.92–06.97	LFZ (XU7JP)	4		ZS 341
1.8 i 16V	1.8	81	01.96–06.97	LFY (XU7JP4)	4		ZS 256
1.8 i 16V	1.8	81	01.96–06.97	LFY (XU7JP4) Org.Nr.07609→	4		ZS 349
1.9 i	1.9	88	03.91–06.97	D6E	4	ZM 026	
1.9 i	1.9	88	03.91–06.97	DKZ (XU9JA)	4	ZM 001	ZS 341
2.0 i	2.0	89	07.92–06.97	RFX (XU10J2C)	4		ZS 341
2.0 i 16V	2.0	110	06.94–06.97	XU10J4TEZ	4		ZS 323
2.0 i 16V	2.0	110	06.94–06.97	RFT (XU10J4/Z)	4	ZM 026	ZS 341
2.0 i 16V	2.0	110	07.95–06.97	RFT (XU10J4/Z)	4	ZM 026	ZS 346
2.0 i 16V	2.0	112	07.92–10.94	XU10J4TEZ	4		ZS 323
2.0 i 16V	2.0	112	07.92–10.94	RFT (XU10J4/Z)/RFY (XU10J4/Z)	4	ZM 026	ZS 341
2.0 i 16V	2.0	120	05.96–06.97	XU10J4TEZ	4		ZS 323
2.0 i 16V	2.0	120	05.96–06.97	RFS (XU10J4RS)	4		ZS 341
2.0 i 16V	2.0	120	05.96–06.97	RFS (XU10J4RS)	4		ZS 346
<b>ZX Break</b>							
1.4 i	1.4	55	10.93–10.97	KFX (TU3JP)/KDX (TU3M/Z)/KDY (TU3M) Org.Nr.5783→	4	ZM 003	ZS 231
1.4 i	1.4	55	10.93–10.97	KFX (TU3JP)/KDX (TU3M/Z)/KDY (TU3M)	4	ZM 003 <sup>283,285</sup>	ZS 249
1.6 i	1.6	65	10.93–10.97	BFZ (XU5JP)/BDY (XU5M)	4		ZS 341
1.8 i	1.8	74	10.93–10.97	LFZ (XU7JP)	4		ZS 341
1.8 i 16V	1.8	81	01.96–02.98	LFY (XU7JP4)	4		ZS 256
1.8 i 16V	1.8	81	01.96–02.98	LFY (XU7JP4) Org.Nr.07609→	4		ZS 349



## C15

1.1	1.1	35	10.84–07.88	109K/E1A	4	ZM 001	
1.1	1.1	35	10.84–12.96	E1A	4		ZS 257
1.1 i	1.1	44	07.88–12.96	HDZ (TU1M)	4		ZS 247
1.4	1.4	49	07.87–12.96	K1H (TU3A)	4	ZM 003	ZS 247
1.4 E	1.4	44	05.87–12.96	150D (XY7)	4	ZM 001	
1.4 i	1.4	55	05.91–12.96	KDY (TU3FM)/KDY (TU3M)	4	ZM 003	ZS 247
<b>C25</b>							
1.8 E	1.8	51	07.87–02.94	169 (XM7T)	4	ZM 001	
2.0	2.0	62	02.91–02.94	170C (XN1T)	4	ZM 001	
2.0 E	2.0	58	09.81–02.94	170B (XN1T)/170A (XN1T)	4	ZM 001	
<b>JUMPER</b>							
2.0	2.0	80	02.94–04.02	RFW (XU10J2U)	4		ZS 341
2.0 4x4	2.0	80	08.96–04.02	RFW (XU10J2U)	4		ZS 341
2.0	2.0	81	04.02–	XU10J2	4		ZS 341
2.0 bivalent	2.0	81	02.03–	XU10J2	4		ZS 341





kW

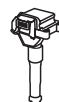

**DACIA**

<b>1310</b>							
1.3	1.3	40	05.83–12.98	810-02/-99	4		<b>ZS 106</b>
<b>DUSTER</b>							
1.6 16V	1.6	77	04.10–	K4M 696/K4M 690	4		<b>ZS 052<sup>282</sup> GS 29</b>
1.6 16V 4x4	1.6	77	06.10–	K4M 606	4		<b>ZS 052<sup>282</sup> GS 29</b>
1.6 16V LPG	1.6	77	04.11–	K4M 696	4		<b>ZS 052<sup>282</sup> GS 29</b>
<b>LOGGY</b>							
1.2 TCe	1.2	85	03.12–	H5F 402	4		<b>ZSE 131</b>
<b>LOGAN</b>							
1.4	1.4	55	09.04–	K7J 710	4		<b>ZS 354</b>
1.4 MPI LPG	1.4	55	02.06–	K7J 714/K7J 710	4		<b>ZS 354</b>
1.6	1.6	64	09.04–	K7M 710	4		<b>ZS 354</b>
1.6 16V	1.6	77	02.06–	K4M 696/K4M 690	4		<b>ZS 052<sup>282</sup> GS 29</b>
<b>LOGAN MCV</b>							
1.4	1.4	55	02.07–	K7J 710	4		<b>ZS 354</b>
1.6	1.6	64	02.07–	K7M 710	4		<b>ZS 354</b>
1.6 16V	1.6	77	02.07–	K4M 690 , K4M 696	4		<b>ZS 052<sup>282</sup> GS 29</b>
1.6 16V Flexifuel	1.6	77	11.09–	K4M 694/K4M 690	4		<b>ZS 052<sup>282</sup> GS 29</b>
1.6 Bifuel	1.6	64	11.08–	K7M 710	4		<b>ZS 354</b>
1.6 MPI 85	1.6	62	05.10–	K7M 800	4		<b>ZS 354</b>
<b>SANDERO</b>							
1.2 16V	1.1	55	11.08–	D4F 732	4		<b>ZS 325</b>
1.4	1.4	55	06.08–	K7J 710	4		<b>ZS 354</b>
1.4 MPI LPG	1.4	53	01.09–	K7J 714	4		<b>ZS 354</b>
1.6	1.6	64	06.08–	K7M 710	4		<b>ZS 354</b>
1.6 16V Bifuel	1.6	77	01.11–	K4M 696	4		<b>ZS 052<sup>282</sup> GS 29</b>
1.6 MPI 85	1.6	62	05.10–	K7M 800	4		<b>ZS 354</b>

**DAEWOO**

<b>KORANDO</b>							
2.3	2.3	105	01.99–	M 161.970	4		<b>ZS 340 ZLE 234</b>
3.2 4x4	3.2	156	01.99–	M 104.995	6		<b>ZS 340 ZLE 234</b>
<b>LACETTI</b>							
1.8 CDX	1.8	67	08.03–12.04	F18D2	4		<b>ZS 508</b>
1.8 CDX	1.8	90	08.03–12.04	T18SED	4		<b>ZS 508</b>
1.8	1.8	90	02.04–	T18SED	4		<b>ZS 508</b>
<b>MUSSO</b>							
2.3	2.3	103	01.99–	M 111.970	4		<b>ZS 340 ZLE 234</b>
3.2 4x4	3.2	162	01.99–	M 104.992	6		<b>ZS 340 ZLE 234</b>
<b>NUBIRA</b>							
1.8	1.8	90	07.03–	T18SED	4		<b>ZS 508</b>

**DAIHATSU**

<b>APPLAUSE I</b>							
1.6 16V	1.6	77	01.90–07.97	HD-E	4		<b>ZM 053</b>
<b>CHARADE II</b>							
1.0	1.0	38	10.83–03.87	CB 22/CB 20	3		<b>ZS 109</b>
<b>CHARMANT</b>							
1.3	1.3	48	11.81–07.87	4K	4		<b>ZS 110</b>

**DAIMLER**

<b>XJ 40, 81</b>							
Sovereign 3.6	3.6	136	10.86–08.89		6		<b>ZS 126</b>

**DODGE**

<b>CHARGER</b>							
3.5	3.5	186	06.05–12.10	EGG	6		<b>ZS 432</b>
<b>INTREPID</b>							
2.7	2.7	149	10.97–09.04	EER	6		<b>ZS 431</b>



kW

**DODGE****INTREPID**

3.2	3.2	168	04.98–09.04	EKK	6		<b>ZS 432</b>
3.5	3.5	160	10.92–12.98	EGE	6		<b>ZS 432</b>

**FERRARI****348 tb/GTB**

3.4	3.4	221	02.90–10.93	F 119 F 000	8	<b>ZM 026</b>	<b>ZS 234</b>
3.4	3.4	235	10.93–04.94	F 119 D 040	8	<b>ZM 026</b>	<b>ZS 234</b>

**348 ts/GTS**

3.4	3.4	221	08.90–10.93	F 119 F 000	8	<b>ZM 026</b>	<b>ZS 234</b>
3.4	3.4	235	10.93–12.95	F 119 D 040	8	<b>ZM 026</b>	<b>ZS 234</b>

**458 ITALIA**

4.5	4.5	419	12.09–		8		<b>ZSE 127</b>
-----	-----	-----	--------	--	---	--	----------------

**458 SPIDER**

4.5	4.5	419	09.11–		8		<b>ZSE 127</b>
-----	-----	-----	--------	--	---	--	----------------

**599 GTB/GTO**

6.0 GTB	6.0	456	06.06–		12		<b>ZSE 128</b>
---------	-----	-----	--------	--	----	--	----------------

**CALIFORNIA**

4.3	4.3	338	07.08–	F 131 B48	8		<b>ZSE 128</b>
-----	-----	-----	--------	-----------	---	--	----------------

**F355 BERLINETTA**

3.5	3.5	280	05.94–03.99	F 129B/40	8	<b>ZM 026</b>	<b>ZS 234</b>
-----	-----	-----	-------------	-----------	---	---------------	---------------

**F355 GTS**

3.5 Spider	3.5	280	07.94–03.99	F 129B/40	8	<b>ZM 026</b>	<b>ZS 234</b>
------------	-----	-----	-------------	-----------	---	---------------	---------------

**MONDIAL**

3.4 T	3.4	221	03.89–12.93	F 119 D	8	<b>ZM 026</b>	<b>ZS 234</b>
-------	-----	-----	-------------	---------	---	---------------	---------------

**TESTAROSSA**

5.0	4.9	272	12.89–10.91	F 113 B..	12	<b>ZM 061</b>	
-----	-----	-----	-------------	-----------	----	---------------	--

5.0	4.9	287	12.89–12.91	F 113 A..	12	<b>ZM 061</b>	
-----	-----	-----	-------------	-----------	----	---------------	--

**FIAT****126**

650	0.7	17	07.77–09.87	126 A1.000/126 A1.048	2		<b>ZS 106</b>
-----	-----	----	-------------	-----------------------	---	--	---------------

650	0.7	18	07.81–09.00	126 A1.048	2		<b>ZS 106</b>
-----	-----	----	-------------	------------	---	--	---------------

**500**

0.9	0.9	63	07.10–	312 A2.000	2		<b>ZS 090</b> <b>GS 51</b>
-----	-----	----	--------	------------	---	--	----------------------------

1.2	1.2	51	10.07–	169 A4.000	4		<b>ZS 079</b>
-----	-----	----	--------	------------	---	--	---------------

1.2 LPG	1.2	51	12.10–	169 A4.000	4		<b>ZS 079</b>
---------	-----	----	--------	------------	---	--	---------------

1.4	1.4	74	10.07–	169 A3.000	4		<b>ZS 322</b>
-----	-----	----	--------	------------	---	--	---------------

1.4 Abarth	1.4	99	08.08–	312 A1.000	4		<b>ZS 095</b> <sup>202</sup>
------------	-----	----	--------	------------	---	--	------------------------------

1.4 Abarth	1.4	99	08.08–	312 A1.000	4		<b>ZS 322</b> <sup>202</sup>
------------	-----	----	--------	------------	---	--	------------------------------

1.4 Abarth	1.4	132	08.08–	312 A3.000	4		<b>ZS 095</b>
------------	-----	-----	--------	------------	---	--	---------------

**500 C**

0.9	0.9	63	09.09–	312 A2.000	2		<b>ZS 090</b> <b>GS 51</b>
-----	-----	----	--------	------------	---	--	----------------------------

1.2	1.2	51	09.09–	169 A4.000	4		<b>ZS 079</b>
-----	-----	----	--------	------------	---	--	---------------

1.4	1.4	74	09.09–	169 A3.000	4		<b>ZS 322</b>
-----	-----	----	--------	------------	---	--	---------------

**ARGENTA**

1600	1.6	72	04.81–12.85	132 D.000	4		<b>ZS 106</b>
------	-----	----	-------------	-----------	---	--	---------------

2000 i.e.	2.0	90	06.81–07.86	132 C3.000	4		<b>ZS 106</b>
-----------	-----	----	-------------	------------	---	--	---------------

2000 i.e.	2.0	90	06.81–07.86	132 C3.000	4		<b>ZS 115</b>
-----------	-----	----	-------------	------------	---	--	---------------

2000 Volumex	2.0	99	06.84–07.85		4	<b>ZM 061</b>	
--------------	-----	----	-------------	--	---	---------------	--

**BRAVA**

1.2 16V 80	1.2	59	10.00–10.01	188 A5.000	4		<b>ZS 234</b>
------------	-----	----	-------------	------------	---	--	---------------

1.2 16V 80	1.2	60	12.98–10.00	182 B2.000	4		<b>ZS 234</b>
------------	-----	----	-------------	------------	---	--	---------------

1.4	1.4	55	10.95–10.01	182 A5.000	4		<b>ZS 234</b>
-----	-----	----	-------------	------------	---	--	---------------

1.4 12 V	1.4	59	10.95–08.98	182 A3.000	4		<b>ZS 234</b>
----------	-----	----	-------------	------------	---	--	---------------

1.6 16V	1.6	66	10.95–10.01	182 A6.000	4		<b>ZS 029</b>
---------	-----	----	-------------	------------	---	--	---------------

1.6 16V	1.6	76	02.96–10.01	182 A4.000	4		<b>ZS 029</b>
---------	-----	----	-------------	------------	---	--	---------------

1.6 16V	1.6	76	01.99–12.02	182 B6.000	4		<b>ZS 029</b>
---------	-----	----	-------------	------------	---	--	---------------

2.0	2.0	113	09.98–08.00	182 B7.000	5		<b>ZS 311</b>
-----	-----	-----	-------------	------------	---	--	---------------

**BRAVO I**

1.2 16V 80	1.2	59	10.00–10.01	188 A5.000	4		<b>ZS 234</b>
------------	-----	----	-------------	------------	---	--	---------------

1.2 16V 80	1.2	60	12.98–10.00	182 B2.000	4		<b>ZS 234</b>
------------	-----	----	-------------	------------	---	--	---------------



kW



FIAT							
<b>BRAVO I</b>							
1.4	1.4	55	10.95–10.01	182 A5.000	4		ZS 234
1.4	1.4	59	10.95–10.01	182 A3.000	4		ZS 234
1.6	1.6	76	09.00–02.02	182 B6.000	4		ZS 029
1.6 16V	1.6	66	10.95–10.01	182 A6.000	4		ZS 029
1.6 16V	1.6	76	03.96–10.01	182 A4.000	4		ZS 029
2.0 HGT 20V	2.0	108	10.95–07.98	182 A1.000	5		ZS 310
2.0 HGT 20V	2.0	113	07.98–10.01	182 B7.000	5		ZS 311
<b>BRAVO II</b>							
1.4	1.4	66	04.07–	192 B2.000	4		ZS 322
1.4 LPG	1.4	66	11.09–	192 B2.000	4		ZS 322
1.4 T-Jet	1.4	88	09.07–	198 A4.000	4		ZS 095 <sup>202</sup>
1.4 T-Jet	1.4	88	09.07–	198 A4.000	4		ZS 322 <sup>202</sup>
1.4 T-Jet	1.4	110	09.07–	198 A1.000	4		ZS 095 <sup>202</sup>
1.4 T-Jet	1.4	110	09.07–	198 A1.000	4		ZS 322 <sup>202</sup>
<b>CINQUECENTO</b>							
0.7	0.7	23	01.92–01.96	170 A.000	2		ZS 283
0.7 i	0.7	22	07.94–01.98	170 A.046	2		ZS 283
0.9	0.9	30	07.91–12.93	170 A1.000	4		ZS 283
0.9 i.e.	0.9	30	07.91–12.93	170 A1.046	4		ZS 283
0.9 i.e. S	0.9	29	07.91–07.99	1170 A1.000/1170 A1.046	4		ZS 283
1.1 Sporting	1.1	40	10.94–01.98	176 B2.000	4		ZS 283
<b>COUPE</b>							
2.0 16V Turbo	2.0	140	11.93–08.96	175 A1.000	4		ZS 283
2.0 20V	2.0	108	08.96–04.98	182 A1.000	5		ZS 310
2.0 20V	2.0	113	04.98–08.00	182 B3.000	5		ZS 311
2.0 20V Turbo	2.0	162	08.96–08.00	175 A3.000	5		ZS 310
<b>CROMA (154)</b>							
2000 16V	2.0	101	08.92–08.96	154 E1.000	4		ZS 234
2000 CHT	2.0	66	12.85–02.89	154 A1.000	4	ZM 005	ZS 248
2000 CHT	2.0	74	01.91–09.92		4	ZM 005	
2000 i.e.	2.0	83	03.86–09.90	834 B.048	4		ZS 106
2000 i.e.	2.0	83	03.86–09.90	834 B.048	4		ZS 115
2000 i.e.	2.0	83	03.86–09.90	834 B.048	4		ZS 248
2000 i.e.	2.0	85	10.87–08.96	154 C3.046/834 B.146	4		ZS 106
2000 i.e.	2.0	85	10.87–08.96	154 C3.046/834 B.146	4		ZS 115
2000 i.e.	2.0	88	03.87–09.92	834 B.000/154 C3.000	4		ZS 106
2000 i.e.	2.0	88	03.87–09.92	834 B.000/154 C3.000	4		ZS 115
2000 i.e. Turbo	2.0	110	06.87–08.96	154 C4.046/834 C.146	4	ZM 061	
2000 i.e. Turbo	2.0	111	11.86–11.88	834 C.146	4	ZM 061	
2000 i.e. Turbo	2.0	114	12.85–06.90	154 A2.000	4	ZM 061	ZS 106
2000 i.e. Turbo	2.0	114	12.85–06.90	154 A2.000	4	ZM 061	ZS 115
2500 V6	2.5	119	06.93–08.96	834 G.000	6		ZS 230
<b>CROMA (194)</b>							
1.8 16V	1.8	103	12.05–	939 A4.000	4		ZS 427
<b>DOBLO (119)</b>							
1.2	1.2	48	03.01–	223 A5.000	4		ZS 283
1.4	1.4	57	10.05–	350 A1.000	4		ZS 079
1.6 16V	1.6	76	10.01–	182 B6.000	4		ZS 320
1.6 Natural Power	1.6	76	09.02–	182 B6.000	4		ZS 029
<b>DOBLO (263)</b>							
1.4	1.4	70	02.10–	843 A1.000	4		ZS 322
1.4	1.4	88	10.11–	198 A4.000	4		ZS 095
1.4 Natural Power	1.4	88	02.10–	198 A4.000	4		ZS 095
<b>DOBLO Cargo (223)</b>							
1.2	1.2	48	03.01–	223 A5.000	4		ZS 283
1.4	1.4	57	10.05–	350 A1.000	4		ZS 079
1.6 16V	1.6	76	10.01–	182 B6.000	4		ZS 320
1.6 Natural Power	1.6	76	09.02–	182 B6.000	4		ZS 029
<b>DOBLO Cargo (263)</b>							
1.4	1.4	70	02.10–	843 A1.000	4		ZS 322
1.4	1.4	88	10.11–	198 A4.000	4		ZS 095



kW



FIAT							
<b>DOBLO Cargo (263)</b>							
1.4 Natural Power	1.4	88	06.10-	198 A4.000	4		ZS 095
<b>DUNA (146 B)</b>							
60 1.1	1.1	43	01.87-12.91	146 A6.000	4	ZM 009	ZS 248
70 1.3	1.3	49	01.87-12.91	146 A5.000	4	ZM 009	ZS 248
<b>IDEA</b>							
1.2 16V	1.2	59	01.04-	188 A5.000	4		ZS 322
1.4	1.4	57	10.05-	350 A1.000	4		ZS 079
1.4 16V	1.4	70	01.04-	843 A1.000	4		ZS 322
1.4 LPG	1.4	57	03.09-	350 A1.000	4		ZS 079
<b>LINEA</b>							
1.4	1.4	57	06.07-	350 A1.000	4		ZS 079
1.4 T-Jet	1.4	88	09.07-	198 A4.000	4		ZS 095
<b>MAREA</b>							
1.2 16V	1.2	60	10.98-05.02	182 B2.000	4		ZS 234
1.4 80 12V	1.4	59	09.96-05.02	182 A3.000	4		ZS 234
1.6	1.6	76	09.00-08.02	182 B6.000	4		ZS 029
1.6 100 16V	1.6	76	09.96-05.02	182 A4.000	4		ZS 029
2.0 150 20V	2.0	108	09.96-04.99	182 A1.000	5		ZS 310
2.0 150 20V	2.0	110	01.01-05.02	185 A8.000	5		ZS 311
2.0 155 20V	2.0	113	04.99-01.01	182 B7.000	5		ZS 311
<b>MAREA Weekend</b>							
1.2 16V	1.2	60	10.98-05.02	182 B2.000	4		ZS 234
1.4 80 12V	1.4	59	09.96-05.02	182 A3.000	4		ZS 234
1.6	1.6	76	09.00-08.02	182 B6.000	4		ZS 029
1.6 100 16V	1.6	76	09.96-05.02	182 A4.000	4		ZS 029
2.0 150 20V	2.0	108	09.96-04.99	182 A1.000	5		ZS 310
2.0 150 20V	2.0	110	01.01-05.02	185 A8.000	5		ZS 311
2.0 155 20V	2.0	113	04.99-01.01	182 B7.000	5		ZS 311
<b>MULTIPLA</b>							
1.6	1.6	76	09.00-06.10	182 B6.000	4		ZS 029
1.6 100 16V	1.6	76	04.99-06.10	182 A4.000	4		ZS 029
1.6 16V	1.6	70	04.02-06.10	182 B6.000	4		ZS 029
1.6 16V Bipower	1.6	76	04.99-06.10	186 A4.000	4		ZS 029
1.6 16V Bipower	1.6	76	10.01-06.10	182 B6.000	4		ZS 029
1.6 16V Blupower	1.6	70	04.99-06.10	186 A3.000	4		ZS 029
<b>PALIO</b>							
1.0	1.0	45	04.96-		4		ZS 283
1.2	1.2	54	06.98-	178 B5.000/178 E2.000/176 A8.000	4		ZS 283
1.6 16V	1.6	74	04.96-	178 B3.000	4		ZS 029
<b>PANDA (141A)</b>							
750	0.8	25	01.86-01.95	141 B.000	4	ZM 009	ZS 106
750	0.8	25	01.88-01.95	156 A4.000	4	ZM 017	ZS 106
750	0.8	25	01.86-01.95	156 A4.000	4	ZM 009	ZS 106
750 KAT	0.8	25	01.95-12.97	156 A4.048	4	ZM 009	ZS 248
750 KAT	0.8	25	01.95-12.97	156 A4.048	4	ZM 017	ZS 248
800	0.8	25	02.81-12.85		4		ZS 106
800	0.8	25	02.81-12.85		4		ZS 115
900	0.9	29	04.92-12.96	1170 A1.046	4		ZS 283
900	0.9	33	10.80-06.94	146 A.000/100 GL3.000	4		ZS 106
900	0.9	33	10.80-06.94	146 A.000/100 GL3.000	4		ZS 115
1000	1.0	32	01.88-04.92	156 A2.100	4	ZM 017	
1000	1.0	32	01.86-04.92	156 A2.100	4	ZM 009	ZS 106
1000	1.0	32	01.86-04.92	156 A2.100	4	ZM 009	ZS 115
1000	1.0	37	01.85-12.92	156 A3.000	4	ZM 009	
1000	1.0	37	01.88-12.92	156 A3.000	4	ZM 017	
1000 4x4	1.0	32	01.86-07.89	156 A3.100/156 A2.100	4	ZM 009	ZS 248
1000 4x4	1.0	32	01.88-07.89	156 A3.100/156 A2.100	4	ZM 017	ZS 248
1000 4x4	1.0	33	05.86-12.94	141 C2.000/156 A2.246	4	ZM 009	
1000 4x4	1.0	33	01.88-12.94	141 C2.000/156 A2.246	4	ZM 017	
1000 4x4	1.0	33	05.86-12.94	141 C2.000/156 A2.246	4		ZS 248

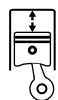

kW

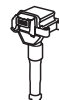
**FIAT****PANDA (141A )**

1000 4x4	1.0	37	01.86–06.90	156 A3.000	4		ZS 106
1000 4x4	1.0	37	01.88–12.92	156 A3.000	4	ZM 017	
1000 4x4	1.0	37	01.86–12.92	156 A3.000	4	ZM 009	ZS 115
1000 i.e. KAT	1.0	33	10.87–08.98	141 C2.000/156 A2.246	4	ZM 009	ZS 106
1000 i.e. KAT	1.0	33	10.87–08.98	141 C2.000/156 A2.246	4	ZM 017	ZS 115
1000 i.e. KAT	1.0	33	09.92–08.98	141 C2.000/156 A2.246	4	ZM 017	ZS 283
1100	1.1	37	01.93–12.99	156 C.046	4		ZS 283
1100	1.1	40	02.95–09.03	187 A1.000/176 B2.000	4		ZS 283
1100 4x4	1.1	40	02.95–07.04	176 B2.000	4		ZS 283
1100 Trekking 4x4	1.1	37	01.93–07.04	156 C.046	4		ZS 283

**PANDA (169)**

1.1	1.1	40	09.03–	187 A1.000	4		ZS 283
1.2	1.2	44	09.03–	188 A4.000	4		ZS 283
1.2 4x4	1.2	44	10.04–	188 A4.000	4		ZS 283
1.2 Bi-Power / Natural Power	1.2	44	01.07–	188 A4.000	4		ZS 283
1.2 LPG	1.2	44	04.09–	188 A4.000	4		ZS 283
1.2 LPG	1.2	51	11.10–	169 A4.000	4		ZS 283
1.4 Bi-Power / Natural Power	1.4	57	09.10–	350 A1.000	4		ZS 079
1.4	1.4	74	10.06–	169 A3.000	4		ZS 322

**PANDA (312)**

0.9	1.0	48	02.12–	312 A4.000	2		ZS 283
-----	-----	----	--------	------------	---	--	--------

**PUNTO (176)**

55 1.1	1.1	40	09.93–09.99	176 A6.000/176 B2.000	4		ZS 283
60 1.2	1.2	43	01.94–09.99	176 A7.000	4		ZS 283
60 1.2	1.2	44	03.94–09.99	176 B1.000/176 B4.000	4		ZS 283
75 1.2	1.2	54	10.93–09.99	176 A8.000	4		ZS 283
85 16V 1.2	1.2	63	04.97–09.99	176 B9.000	4		ZS 283
1.4 GT Turbo	1.4	96	09.96–09.99	176 B6.000	4	ZM 026	ZS 234
1.4 GT Turbo	1.4	98	01.94–09.96	176 A4.000	4		ZS 234

**PUNTO (188)**

1.2 16V 80	1.2	59	09.99–	188 A5.000	4		ZS 234
1.2 60	1.2	44	09.99–	188 A4.000	4		ZS 283
1.2 Bifuel	1.2	44	08.07–	188 A4.000	4		ZS 283
1.2 Natural Power	1.2	44	09.03–	188 A4.000	4		ZS 283
1.4	1.4	70	09.03–	843 A1.000	4		ZS 322

**PUNTO / GRANDE PUNTO (199)**

1.2	1.2	48	10.05–	199 A4.000	4		ZS 079
1.4	1.4	55	06.06–	199 A7.000	4		ZS 079
1.4	1.4	57	10.05–	350 A1.000	4		ZS 079
1.4 16V	1.4	70	10.05–	199 A6.000	4		ZS 322
1.4 Abarth	1.4	114	12.07–	199 A8.000	4		ZS 095
1.4 Natural Power	1.4	57	07.08–	350 A1.000	4		ZS 079
1.4 T-Jet	1.4	88	09.07–	198 A4.000	4		ZS 095

**PUNTO EVO**

1.2	1.2	48	10.09–02.12	199 A4.000	4		ZS 079
1.2	1.2	51	10.09–02.12	169 A4.000	4		ZS 079
1.4	1.4	57	10.09–02.12	350 A1.000	4		ZS 079

**QUBO (225)**

1.4	1.4	54	09.08–	KFT/KFV	4		ZSE 048
-----	-----	----	--------	---------	---	--	---------

**REGATA**

70 1.3	1.3	48	07.88–07.89	149 A3.000/149 A7.000	4		ZS 248
75 1.5	1.5	55	12.83–12.87	138 C3.048/138 B3.048	4		ZS 248
75 i.e. 1.5	1.5	55	07.85–07.89	149 C1.000/138 C2.048	4		ZS 248
85 1.5	1.5	58	05.85–12.87	149 A5.000	4	ZM 005	
85 Super 1.5	1.5	60	09.83–04.85	138 B3.000	4	ZM 005	
90 i.e. 1.6	1.6	66	01.87–07.89	149 C2.000	4	ZM 005	
100 Super 1.6	1.6	70	06.86–07.89	149 C3.000	4	ZM 043	
100 Super 1.6	1.6	74	06.86–12.90	149 A2.000/149 A4.000	4	ZM 043	
100 Super 1.6	1.6	74	10.83–12.90	149 A2.000/149 A4.000	4		ZS 248



kW



FIAT								
<b>RITMO II</b>								
60 1.1	1.1	40	10.82–10.85	138 C1.000/138 B.000/138 B1.000	4		<b>ZS 106</b>	
60 1.1	1.1	40	10.82–10.85	138 C1.000/138 B.000/138 B1.000	4		<b>ZS 115</b>	
60 1.1	1.1	43	04.85–12.87	146 A4.048	4		<b>ZS 106</b>	
60 1.1	1.1	43	04.85–12.87	146 A4.048	4		<b>ZS 115</b>	
70 1.3	1.3	50	01.83–04.85	138 B2.000	4		<b>ZS 106</b>	
70 1.3	1.3	50	01.83–04.85	138 B2.000	4		<b>ZS 115</b>	
75 1.5 KAT	1.5	55	09.85–12.88	149 C1.000/138 C2.048 Mot.Nr.6114921→	4		<b>ZS 248</b>	
85 1.5	1.5	60	01.83–12.87	138 B3.000	4		<b>ZS 106</b>	
85 1.5	1.5	60	01.83–12.87	138 B3.000	4		<b>ZS 115</b>	
<b>SEICENTO</b>								
0.9	0.9	29	01.98–01.10	1170 A1.046	4		<b>ZS 283</b>	
1.1	1.1	40	01.98–01.10	187 A1.000/176 B2.000	4		<b>ZS 283</b>	
<b>SIENA</b>								
1.2	1.2	44	09.01–	178 C4.066	4		<b>ZS 283</b>	
1.2	1.2	54	09.98–	178 B5.000	4		<b>ZS 283</b>	
1.4	1.4	51	03.00–06.01	178 B2.000	4		<b>ZS 283</b>	
1.4 KAT	1.4	51	05.98–06.01	178 B2.016	4		<b>ZS 283</b>	
1.5	1.5	62	06.04–	178 E5.022	4		<b>ZS 283</b>	
1.6	1.6	76	11.00–	182 B6.000	4		<b>ZS 029</b>	
1.6 16V	1.6	76	09.98–	178 B3.000	4		<b>ZS 029</b>	
1.6 16V	1.6	78	09.98–	178 B3.000	4		<b>ZS 029</b>	
<b>STILO</b>								
1.2 16V	1.2	59	02.02–11.06	188 A5.000	4		<b>ZS 322</b>	
1.4 16V	1.4	66	03.05–11.06	192 B2.000	4		<b>ZS 322</b>	
1.4 16V	1.4	70	01.04–11.06	843 A1.000	4		<b>ZS 322</b>	
1.6 16V	1.6	77	05.05–11.06	192 B30	4		<b>ZS 427</b>	
1.6 16V	1.6	76	10.01–11.06	182 B6.000	4		<b>ZS 320</b>	
2.4 20V	2.4	125	10.01–12.03	192 A2.000	5		<b>ZS 321</b>	
<b>STILO Multi Wagon</b>								
1.4 16V	1.4	66	03.05–08.08	192 B2.000	4		<b>ZS 322</b>	
1.4 16V	1.4	70	01.04–08.08	843 A1.000	4		<b>ZS 322</b>	
1.6 16V	1.6	76	01.03–08.08	182 B6.000	4		<b>ZS 320</b>	
<b>STRADA</b>								
1.2	1.2	44	04.03–	188 A4.000	4		<b>ZS 283</b>	
1.2	1.2	54	06.99–	178 B5.000	4		<b>ZS 283</b>	
<b>TEMPRA</b>								
1.4 i.e.	1.4	51	03.92–03.93	836 A4.000/160 A1.046	4		<b>ZS 244</b>	
1.4 i.e.	1.4	51	03.95–08.96	836 A4.000/160 A1.046	4		<b>ZS 234</b>	
1.4 i.e.	1.4	57	03.91–08.96	159 A2.000	4	<b>ZM 009</b>	<b>ZS 234</b>	
1.6	1.6	63	03.90–04.93	159 A3.000	4	<b>ZM 009</b>		
1.6 i.e.	1.6	55	06.92–08.96	159 A3.048/835 C1.000	4		<b>ZS 234</b>	
1.8 i.e.	1.8	66	09.93–08.96	835 C4.000	4		<b>ZS 283</b>	
1.8 i.e.	1.8	74	10.94–08.96	836 A5.000	4		<b>ZS 283</b>	
1.8 i.e.	1.8	76	09.93–08.96	835 C2.000	4		<b>ZS 283</b>	
1.8 i.e.	1.8	81	03.90–08.96	159 A4.000	4		<b>ZS 283</b>	
<b>TEMPRA S.W.</b>								
1.4 i.e.	1.4	51	10.92–08.96	836 A4.000/160 A1.046	4		<b>ZS 234</b>	
1.6	1.6	63	12.90–04.93	159 A3.000	4	<b>ZM 009</b>		
1.6 i.e.	1.6	55	10.92–08.96	159 A3.048/835 C1.000	4		<b>ZS 234</b>	
1.8 i.e.	1.8	66	09.93–08.96	835 C4.000	4		<b>ZS 283</b>	
1.8 i.e.	1.8	74	10.94–08.96	836 A5.000	4		<b>ZS 283</b>	
1.8 i.e.	1.8	76	09.93–08.96	835 C2.000	4		<b>ZS 283</b>	
<b>TIPO</b>								
1.1	1.1	41	01.89–10.91	160 A3.000	4	<b>ZM 017</b>	<b>ZS 244</b>	
1.4	1.4	52	01.89–12.89	160 A1.000/160 A1.048	4	<b>ZM 017</b>		
1.4 i.e.	1.4	51	05.89–04.95	836 A4.000/160 A1.046	4	<b>ZM 017</b>	<b>ZS 244</b>	
1.4 i.e.	1.4	51	05.89–04.95	836 A4.000/160 A1.046	4	<b>ZM 017</b>	<b>ZS 248</b>	
1.6	1.6	61	01.89–10.91	160 A2.000	4	<b>ZM 017</b>		
1.6 i.e.	1.6	55	10.92–04.95	159 A3.048/835 C1.000	4	<b>ZM 009</b>		
1.6 i.e.	1.6	55	10.92–04.95	159 A3.048/835 C1.000	4	<b>ZM 017</b>		



kW



## FIAT

TIPO							
1.6 i.e.	1.6	55	03.93-04.95	835 C1.000	4		ZS 234
1.6 i.e.	1.6	57	07.90-01.93	159 A3.046 Mot.Nr.→8327193	4	ZM 017	ZS 248
1.8 i.e.	1.8	66	09.93-04.95	835 C4.000	4		ZS 283
1.8 i.e.	1.8	74	10.94-04.95	159 A4.000	4		ZS 283
1.8 i.e.	1.8	76	04.93-04.95	835 C2.000	4		ZS 283
1.8 i.e.16V Sport	1.8	100	11.89-06.92	160 A5.000	4	ZM 061	
<b>ULYSSE (220)</b>							
1.8	1.8	73	05.97-08.02	LFW	4		ZS 341
2.0	2.0	89	06.94-08.02	RFU (XU10J2C)	4		ZS 341
2.0 16V	2.0	97	05.98-09.00	RFV	4		ZS 349
2.0 Turbo	2.0	108	06.94-08.02	RGX (XU10J2CTE)	4	ZM 026	ZS 341
<b>ULYSSE (179AX)</b>							
3.0 V6	2.9	150	08.02-06.11	XFW	6		ZS 347
<b>UNO</b>							
1.3 Turbo i.e.	1.3	74	09.89-03.91	146 A2.246	4	ZM 061	
1.3 Turbo i.e.	1.3	77	04.85-08.89	146 A2.000	4	ZM 061	
45 0.9	0.9	33	01.89-09.92	146 A.000/146 A.1000	4	ZM 017	
45 0.9	0.9	33	03.83-09.92	146 A.000/146 A.1000	4		ZS 106
45 1.0	1.0	32	01.87-12.87	156 A2.048/156 A2.100	4		ZS 248
45 1.0	1.0	32	06.86-12.93	156 A2.048/156 A2.100	4	ZM 009	
45 1.0	1.0	32	01.88-12.93	156 A2.048/156 A2.100	4		ZS 244
45 1.0	1.0	37	06.86-12.93		4	ZM 009	
45 1.0	1.0	37	01.89-12.93		4	ZM 017	
45 i.e. 1.0	1.0	33	01.88-10.95	156 A2.246	4		ZS 244
45 i.e. 1.0	1.0	33	01.87-12.87	156 A2.246	4		ZS 248
50 1.1	1.1	37	01.90-12.93	156 C.046	4	ZM 009	ZS 244
50 i.e. 1.1	1.1	36	06.92-12.93	146 C3.000	4	ZM 009	
55 1.0	1.0	41	11.93-08.00		4		ZS 248
60 1.1	1.1	42	04.89-12.92	160 A3.000	4		
60 1.1	1.1	42	04.89-12.92	160 A3.000	4	ZM 009	ZS 244
60 1.1	1.1	43	05.85-08.89	146 A4.048	4		
60 1.1	1.1	43	05.85-08.89	146 A4.048	4	ZM 009	ZS 248
70 1.3	1.3	48	05.85-08.89	149 A7.000	4		ZS 248
70 i.e. 1.4	1.4	51	09.89-12.93	160 A1.046	4		ZS 248
75 i.e. 1.5	1.5	55	10.85-12.88	149 C1.000/138 C2.048	4		ZS 244
75 i.e. 1.5	1.5	55	01.89-12.93	149 C1.000/138 C2.048	4		ZS 248
<b>X 1/9</b>							
1.5 Five Speed	1.5	63	11.78-12.89	138 AS.000	4		ZS 106
<b>DUCATO</b>							
1.8	1.8	49	01.82-10.88	169 B	4	ZM 001	
2.0	2.0	55	07.85-08.90	170 B	4	ZM 001	
2.0	2.0	58	01.82-08.90	XN 1T	4	ZM 001	
2.0	2.0	80	03.94-04.02	RFW	4		ZS 341
2.0 4x4	2.0	80	11.94-11.01	RFW	4		ZS 341
2.0 Bipower	2.0	81	11.02-	RFL	4		ZS 232
140 Natural Power	3.0	100	04.09-	F1CE0441A	4		ZS 322
<b>FIORINO</b>							
60 1.1	1.1	40	05.88-12.93	146 A9.000	4	ZM 009	
60 1.1	1.1	40	05.88-12.93	146 A9.000	4		ZS 248
70 1.3	1.3	49	01.88-12.94	146 A5.000	4	ZM 009	ZS 248
70 i.e. 1.4	1.4	49	05.94-05.95	146 C5.000/146 D5.000	4		ZS 248
70 i.e. 1.4	1.4	49	06.95-05.01	146 C5.000/146 D5.000	4		ZS 234
75 i.e. 1.5	1.5	55	05.88-12.93	149 C1.000	4		ZS 106
75 i.e. 1.6	1.6	55	06.95-05.01	146 D6.000/146 C6.000	4		ZS 234
1.4	1.4	54	02.08-	KFT/KFV	4		ZSE 048
<b>SCUDO</b>							
1.6	1.6	58	02.96-12.06	220 A 2.000	4		ZS 234





kW



FORD							
<b>C-MAX</b>							
1.6	1.6	74	02.07-07.10	SHDA/HWDB/SHDB/HWDA/SHDC	4		<b>ZS 387</b>
<b>C-MAX II</b>							
1.6 Ti	1.6	77	12.10-	IQDB/IQDA	4		<b>ZS 387</b>
1.6 Ti	1.6	92	12.10-	PNDA	4		<b>ZS 387</b>
<b>COUGAR</b>							
2.5 ST 200	2.5	151	01.00-12.01	SGA	6		<b>ZS 371</b>
2.5 V6 24V	2.5	125	06.00-12.01	LCBC/LCBB/LCBE	6		<b>ZS 371</b>
2.5 V6 24V	2.5	125	08.98-12.01	LCBA	6		<b>ZS 371</b>
2.5 V6 24V	2.5	125	08.98-12.01	LCBA	6		<b>ZS 372</b>
<b>ESCORT (AVA)</b>							
1.3	1.3	51	03.81-01.85	JPA	4	<b>ZM 008</b>	<b>ZS 126</b>
1.3	1.3	51	02.85-02.86	JPA	4	<b>ZM 003</b>	<b>ZS 126</b>
<b>ESCORT (AVF)</b>							
1.1	1.1	37	05.86-07.90	GSG	4	<b>ZM 003</b>	<b>ZS 238</b>
1.1	1.1	37	05.86-07.90	GSG	4	<b>ZM 003</b>	<b>ZS 281</b>
1.3	1.3	46	07.88-07.90	JBA	4		<b>ZS 238</b>
1.3	1.3	46	07.88-07.90	JBA	4		<b>ZS 281</b>
1.4 i	1.4	54	02.86-07.90	F6D/F6B/FUC	4		<b>ZS 126</b>
<b>ESCORT (AVL)</b>							
1.3	1.3	46	07.90-12.94	JBD	4	<b>ZM 003</b>	<b>ZS 237</b>
1.3	1.3	46	07.90-12.94	JBD	4	<b>ZM 003</b>	<b>ZS 238</b>
1.3	1.3	46	07.90-12.94	JBD	4	<b>ZM 003</b>	<b>ZS 281</b>
1.4	1.4	52	07.90-12.94	F6F/F6G	4		<b>ZS 126</b>
1.4	1.4	52	07.90-12.94	F6F/F6G	4		<b>ZS 281</b>
1.4	1.4	54	01.95-	F4B	4		<b>ZS 281</b>
<b>ESCORT III</b>							
1.1	1.1	37	08.83-12.85	GSE	4	<b>ZM 003</b>	
1.3	1.3	51	09.80-12.85	JPA	4	<b>ZM 003</b>	<b>ZS 126</b>
1.6	1.6	58	09.80-01.85	LP1/LPA	4	<b>ZM 008</b>	<b>ZS 126</b>
1.6	1.6	58	02.85-12.85	LP1/LPA	4	<b>ZM 003</b>	<b>ZS 126</b>
1.6	1.6	58	01.85-12.85	CVH	4	<b>ZM 020</b>	<b>ZS 126</b>
1.6 i	1.6	66	07.85-12.85	CVH	4	<b>ZM 020</b>	
1.6 i	1.6	66	08.85-12.85	L4B	4	<b>ZM 003</b>	<b>ZS 126</b>
1.6 RS Turbo	1.6	97	11.84-12.85	LNA	4	<b>ZM 003</b>	<b>ZS 126</b>
1.6 XR3i	1.6	77	10.82-01.85	LRA/LR1	4	<b>ZM 008</b>	<b>ZS 126</b>
1.6 XR3i	1.6	77	02.85-12.85	LRA/LR1	4	<b>ZM 003</b>	<b>ZS 126</b>
<b>ESCORT IV</b>							
1.1	1.1	37	08.87-07.90	GSG	4	<b>ZM 003</b>	
1.3	1.3	44	01.86-07.90	CVH	4	<b>ZM 020</b>	
1.3	1.3	46	07.88-10.90	CVH	4	<b>ZM 020</b>	
1.3	1.3	46	07.88-10.90	JBA	4		<b>ZS 238</b>
1.3	1.3	46	07.88-10.90	JBA	4		<b>ZS 281</b>
1.3	1.3	51	11.86-07.88	CVH	4	<b>ZM 020</b>	
1.4	1.4	51	01.86-07.90	FUAA	4		<b>ZS 126</b>
1.4	1.4	51	01.89-10.90	CVH	4	<b>ZM 020</b>	
1.4	1.4	51	10.85-10.90	FUAA	4		<b>ZS 281</b>
1.4	1.4	54	01.86-07.90	F6D/F6B/FUC	4	<b>ZM 003</b> <sup>283</sup>	<b>ZS 281</b>
1.4	1.4	54	01.86-07.90	F6D/F6B/FUC	4	<b>ZM 020</b> <sup>287</sup>	<b>ZS 126</b>
1.4	1.4	55	01.86-07.90	CVH	4	<b>ZM 020</b>	
1.4	1.4	55	01.86-07.90	FUA	4	<b>ZM 003</b>	<b>ZS 126</b>
1.4	1.4	55	01.86-07.90	FUA	4	<b>ZM 003</b>	<b>ZS 281</b>
1.6	1.6	58	01.86-12.88	CVH	4	<b>ZM 020</b>	
1.6	1.6	58	01.86-12.88	LP2	4	<b>ZM 015</b>	<b>ZS 126</b>
1.6	1.6	58	01.86-12.88	LP2	4	<b>ZM 015</b>	<b>ZS 281</b>
1.6	1.6	65	04.89-07.90	CVH	4	<b>ZM 020</b>	
1.6	1.6	65	04.89-07.90	LUG	4	<b>ZM 015</b>	<b>ZS 126</b>
1.6	1.6	65	04.89-07.90	LUG	4	<b>ZM 015</b>	<b>ZS 281</b>
1.6 i	1.6	66	01.86-05.90	L4B	4	<b>ZM 003</b>	<b>ZS 281</b>
1.6 i	1.6	66	01.86-05.90	L4B	4	<b>ZM 015</b>	<b>ZS 281</b>
1.6 i	1.6	66	01.86-05.90	CVH	4	<b>ZM 020</b>	
1.6 i	1.6	75	08.89-07.90	LJB	4	<b>ZM 003</b>	<b>ZS 281</b>





kw



<b>FORD</b>							
<b>ESCORT IV</b>							
1.6 i	1.6	75	08.89-07.90	LJB	4	ZM 015	ZS 281
1.6 i	1.6	75	08.89-07.90	CVH	4	ZM 020	
1.6 Turbo RS	1.6	97	01.86-07.90	LNB	4	ZM 015	
1.6 Turbo RS	1.6	97	01.86-07.90	CVH	4	ZM 020	
1.6 Turbo RS	1.6	97	01.86-07.90	LNB	4		ZS 281
1.6 XR3i	1.6	77	01.86-08.89	LRB/LR2	4	ZM 003	ZS 281
1.6 XR3i	1.6	77	01.86-08.89	LRB/LR2	4	ZM 015	ZS 281
<b>ESCORT IV Kombi</b>							
1.1	1.1	37	08.87-09.90	GSG	4	ZM 003	
1.3	1.3	44	01.86-07.90	JLA/JBB/JLB	4	ZM 003	
1.3	1.3	44	01.86-07.90	CVH	4	ZM 020	
1.3	1.3	51	11.86-07.88	CVH	4	ZM 020	
1.4	1.4	51	01.86-07.90	FUAA	4		ZS 126
1.4	1.4	51	10.85-10.90	CVH	4	ZM 020	
1.4	1.4	51	10.85-10.90	FUAA	4		ZS 281
1.4	1.4	54	01.86-07.90	CVH	4	ZM 020	
1.4	1.4	54	02.87-07.90	F6B , F6D , FUC	4		ZS 126
1.4	1.4	54	01.89-07.90	F6D/F6B/FUC	4	ZM 003	ZS 281
1.4	1.4	55	01.86-07.90	CVH	4	ZM 020	
1.4	1.4	55	01.86-07.90	FUA	4	ZM 003	ZS 126
1.4	1.4	55	01.89-07.90	FUA	4	ZM 003	ZS 281
1.6	1.6	58	01.86-07.90	CVH	4	ZM 020	
1.6	1.6	58	01.86-07.90	LP2	4	ZM 015	ZS 126
1.6	1.6	58	01.86-07.90	LP2	4	ZM 015	ZS 281
1.6 i	1.6	66	01.86-07.90	CVH	4	ZM 020	
1.6 i	1.6	66	01.86-07.90	L4B	4	ZM 003	ZS 126
1.6 i	1.6	66	01.86-07.90	L4B	4	ZM 015	ZS 281
<b>ESCORT V</b>							
1.3	1.3	44	07.90-09.92	J6A	4	ZM 003	
1.3	1.3	44	07.90-09.92	J6A/J4B	4		ZS 238
1.3	1.3	44	07.90-09.92	J6A/J4B	4		ZS 281
1.4	1.4	52	07.90-09.92	F6F/F6G	4		ZS 126
1.4	1.4	52	07.90-09.92	F6F/F6G	4		ZS 281
1.6	1.6	66	07.90-08.92	LUJ/LUK	4		ZS 126
1.6	1.6	66	07.90-08.92	CVH 2 VHC , CVH HL 16 EFI	4		ZS 281
1.6	1.6	77	07.90-09.92	LJF	4		ZS 126
1.6	1.6	77	07.90-12.92	LJF	4		ZS 281
1.8 16V XR3i	1.8	77	02.92-12.92	RDA	4		ZS 281
1.8 16V XR3i	1.8	96	02.92-12.92	RGB	4		ZS 281
RS 2000	2.0	110	05.91-12.92	N7A	4		ZS 308
<b>ESCORT V Kombi</b>							
1.3	1.3	44	09.91-09.92	J6A	4	ZM 003	
1.3	1.3	44	09.91-09.92	J6A/J4B	4		ZS 238
1.3	1.3	44	09.91-09.92	J6A/J4B	4		ZS 281
1.4	1.4	52	07.90-09.92	F6F/F6G	4		ZS 126
1.4	1.4	52	07.90-09.92	F6F/F6G	4		ZS 281
1.6	1.6	66	07.90-08.92	LUJ/LUK	4		ZS 281
1.6	1.6	77	07.90-09.92	LJF	4		ZS 126
1.6	1.6	77	07.90-09.92	LJF	4		ZS 281
1.8 16V	1.8	77	02.92-12.92	RDA	4		ZS 281
<b>ESCORT VI</b>							
1.3	1.3	44	09.92-01.95	J6A/J4B	4		ZS 238
1.3	1.3	44	09.92-01.95	J6A/J4B	4		ZS 281
1.4	1.4	52	09.92-01.95	F6F/F6G	4		ZS 126
1.4	1.4	52	09.92-01.95	F6F/F6G	4		ZS 281
1.4	1.4	55	01.94-01.95	F4B/FUH	4	ZM 003	ZS 126
1.4	1.4	55	01.94-01.95	F4B/FUH	4	ZM 003	ZS 281
1.6 i 16V	1.6	65	01.94-01.95	L1H	4		ZS 281
1.6 i 16V	1.6	66	09.92-01.95	L1E	4		ZS 281
1.8 i 16V	1.8	77	09.92-01.95	RDA	4		ZS 239
1.8 i 16V	1.8	77	09.92-01.95	RDA	4		ZS 281



kW



## FORD

## ESCORT VI

1.8 XR3i 16V 4x4	1.8	96	08.93-01.95	RQB	4	ZS 281
RS 2000	2.0	110	09.92-01.95	N7A	4	ZS 308
RS 2000 4x4	2.0	110	08.93-01.95	N7A	4	ZS 308
RS Cosworth 4x4	2.0	162	09.92-01.95	N5F	4	ZS 360
RS Cosworth 4x4	2.0	162	09.92-05.94	N5F	4	ZS 126

## ESCORT VI Kombi

1.3	1.3	44	09.92-01.95	J6A	4	ZM 003
1.3	1.3	44	09.92-01.95	J6A/J4B	4	ZS 238
1.3	1.3	44	09.92-01.95	J6A/J4B	4	ZS 281
1.4	1.4	52	09.92-01.94	F6F/F6G	4	ZS 126
1.4	1.4	52	09.92-01.94	F6F/F6G	4	ZS 281
1.4	1.4	55	01.94-01.95	F4B/FUH	4	ZS 281
1.6 i 16V	1.6	65	01.94-01.95	L1H	4	ZS 281
1.6 i 16V	1.6	66	09.92-01.95	L1E	4	ZS 281
1.8 i 16V	1.8	77	01.93-01.95	RDA	4	ZS 239
1.8 i 16V	1.8	77	01.93-01.95	RDA	4	ZS 281
1.8 i 16V	1.8	96	02.93-01.95	RQB	4	ZS 281

## ESCORT VII

1.3	1.3	44	01.95-08.98	J6A/J4B	4	ZS 238
1.3	1.3	44	01.95-08.98	J6A/J4B	4	ZS 281
1.3	1.3	44	09.98-10.98	J6A/J4B	4	ZS 350
1.4	1.4	55	01.95-10.98	F4B	4	ZS 281
1.6	1.6	70	01.01-08.02	L1K	4	ZS 281
1.6 16V	1.6	66	01.95-10.98	L1E	4	ZS 281
1.6 16V 4x4	1.6	66	01.95-10.98	L1E	4	ZS 281
1.6 i 16V	1.6	65	01.95-08.95	L1H	4	ZS 281
1.8 16V	1.8	77	01.95-08.95	RDA	4	ZS 281
1.8 16V	1.8	85	01.95-10.98	RKC	4	ZS 238
RS 2000	2.0	110	02.95-08.96	N7A	4	ZS 308
RS 2000 4x4	2.0	110	02.95-08.96	N7A	4	ZS 308
RS Cosworth 4x4	2.0	162	02.95-10.98	N5F	4	ZS 360

## ESCORT VII Kombi

1.3	1.3	44	01.95-08.98	J6A/J4B	4	ZM 003	ZS 238
1.3	1.3	44	01.95-08.98	J6A/J4B	4	ZM 003	ZS 281
1.3	1.3	44	09.98-10.98	J6A/J4B	4	ZM 003	ZS 350
1.4	1.4	55	01.95-02.99	F4B/FUH	4	ZS 281	
1.6 16V	1.6	66	01.95-02.99	L1E	4	ZS 281	
1.6 i 16V	1.6	65	01.95-08.95	L1H	4	ZS 281	
1.8 16V	1.8	77	01.95-08.95	RDA	4	ZS 281	
1.8 16V	1.8	85	01.95-02.99	RKC	4	ZS 281	

## FIESTA II

1.0	1.0	33	05.86-02.89	TKB	4	ZM 003	ZS 126
1.1	1.1	36	05.86-02.89	GSH	4	ZM 003 <sup>283</sup>	
1.1	1.1	37	09.83-02.89	GSF/GLC	4	ZS 126	
1.3	1.3	51	09.83-12.85	JPC	4	ZS 126	
1.4	1.4	52	10.86-02.89	F6C/F6A	4	ZM 020	
1.4	1.4	54	02.87-02.89	FUD	4	ZM 020	
1.4	1.4	55	01.86-02.89	FUB	4	ZM 020	ZS 126
1.4	1.4	55	10.85-11.89	FUB	4	ZM 003	
1.6 XR2	1.6	70	01.86-02.89	LUD	4	ZM 020	ZS 126
1.6 XR2	1.6	71	01.86-02.89	LUB	4	ZM 020	ZS 126

## FIESTA III

1.1	1.1	37	03.89-12.91	G6A	4	ZM 047	ZS 238
1.1	1.1	37	01.92-12.95	G6A	4	ZM 047	ZS 237
1.1	1.1	37	03.89-12.95	G6A	4	ZM 047	ZS 281
1.1	1.1	40	03.89-12.95	GUD/GUE	4	ZM 047	ZS 238
1.1	1.1	40	03.89-12.95	GUD/GUE	4	ZM 047	ZS 281
1.3	1.3	44	03.89-12.92	JBC	4	ZS 281	
1.3	1.3	44	03.89-12.95		4	ZS 237	
1.3 KAT	1.3	44	05.91-01.97	J6B	4	ZS 238	
1.3 KAT	1.3	44	01.92-01.97	J6B	4	ZS 281	



kw



**FORD**

**FIESTA III**

1.4	1.4	52	03.89-12.95	F6E	4	ZM 020	
1.4	1.4	52	03.89-12.95	CVH CF ILC	4	ZS 281	
1.4	1.4	54	03.89-12.95	FUG/FUJ	4	ZS 126	
1.4	1.4	54	03.89-12.95	CVH CF ILC	4	ZS 281	
1.4 KAT	1.4	54	03.89-12.93	F4A	4	ZS 126	
1.4 KAT	1.4	54	01.94-12.95	F4A	4	ZS 281	
1.6	1.6	65	03.89-01.94	LUH	4	ZS 126	
1.6	1.6	65	01.89-01.94	LUH	4	ZS 281	
1.6	1.6	65	01.89-07.90	LUH	4	ZM 020	
1.6	1.6	66	03.89-12.92	LUH	4	ZS 126	
1.6	1.6	66	03.89-12.92	LUH	4	ZS 281	
1.6 i 16V	1.6	65	01.94-12.95	L1G	4	ZS 239	
1.6 i 16V	1.6	65	01.94-12.95	L1G	4	ZS 281	
1.6 Turbo	1.6	96	07.90-10.92	LHA	4	ZS 126	
1.6 Turbo	1.6	96	03.90-10.92	LHA	4	ZS 281	
1.6 XR2i	1.6	76	03.89-03.93	LJD	4	ZS 126	
1.6 XR2i	1.6	76	03.89-03.93	LJD	4	ZS 281	
1.6 XR2i	1.6	81	03.89-01.94	LJC	4	ZS 126	
1.8 16V	1.8	77	02.92-12.95	RDB	4	ZS 239	
1.8 16V	1.8	77	02.92-12.95	RDB	4	ZS 281	
1.8 XR2i 16V	1.8	96	02.92-12.93	RQC	4	ZS 281	

**FIESTA IV**

1.25 i 16V	1.2	55	08.95-04.98	DHG/DHB/DHC/DHE/DHF/DHA/DHD	4	ZS 238	
1.25 i 16V	1.2	55	08.95-04.98	DHG/DHB/DHC/DHE/DHF/DHA/DHD	4	ZS 281	
1.25 i 16V	1.2	55	05.98-01.02	DHG/DHB/DHC/DHE/DHF/DHA/DHD	4	ZS 350	
1.3 i	1.3	37	08.95-08.98	JJA/JJE/JJM/JJC/JJJ/JJK	4	ZS 281	
1.3 i	1.3	44	08.95-08.98	J4R/J4C/J4L/J4J/J4Q/J4T	4	ZS 281	
1.4 i 16V	1.4	66	04.96-04.98	FHE/FHA	4	ZS 238	
1.4 i 16V	1.4	66	04.96-04.98	FHE/FHA	4	ZS 281	
1.4 i 16V	1.4	66	05.98-01.02	FHE/FHA	4	ZS 350	
1.6 16V Sport	1.6	76	02.00-01.02	L1V/L1T	4	ZS 281	

**FIESTA V**

1.25 16V	1.2	51	03.05-09.08	M7JA/M7JB	4	ZS 387	
1.25 16V	1.2	55	05.02-02.05	FUJA/FUJB	4	ZS 422	
1.25 16V	1.2	55	03.05-09.08	FUJA/FUJB	4	ZS 387	
1.3	1.3	44	11.01-	BAJA	4	ZS 350 <sup>19</sup>	
1.3	1.3	51	11.01-	A9JA/A9JB	4	ZS 350 <sup>19</sup>	
1.4 16V	1.4	59	11.01-02.05	FXJB/FXJA	4	ZS 350	
1.4 16V	1.4	59	03.05-	FXJB/FXJA	4	ZS 387	
1.6 16V	1.6	74	11.01-02.05	FYJA/FYJB	4	ZS 350	
1.6 16V	1.6	74	03.05-09.08	FYJA/FYJB	4	ZS 387	

**FIESTA VI**

1.25	1.2	44	10.08-	STJA/STJB	4	ZS 387	
1.25	1.2	60	10.08-	SNJA/SNJB	4	ZS 387	
1.4	1.4	71	10.08-	SPJA/SPJC	4	ZS 387	
1.4 LPG	1.4	71	01.09-	RTJA/RTJB	4	ZS 387	
1.6 Ti	1.6	88	10.08-	HXJB/HXJA	4	ZS 387	

**FIESTA Van**

1.3	1.3	51	10.03-	A9JA/A9JB	4	ZS 350 <sup>19</sup>	
1.25	1.2	60	01.09-	SNJA/SNJB	4	ZS 387	

**FOCUS C-MAX**

1.6	1.6	74	03.05-03.07	HWDB/HWDA	4	ZS 387	
1.6 Ti	1.6	85	03.05-03.07	SIDA/HXDA	4	ZS 387	
1.8	1.8	88	10.03-03.07	CSDB/CSDA	4	ZS 408	
1.8	1.8	92	04.04-03.07	QQDA/QQDB/Q7DA	4	ZS 408	

**FOCUS**

1.4 16V	1.4	55	10.98-11.04	FXDA/FXDD/FXDC/FXDB	4	ZS 350	
1.6 16V	1.6	74	10.98-11.04	FYDH/FYDA/FYDB/FYDD/FYDC	4	ZS 350	
1.8 16V	1.8	85	10.98-07.04	EYDD/EYDC/EYDE/EYDL/EYDF/EYDG/EYDB/ EYDJ/EYDI	4	ZS 350	



kW



FORD							
<b>FOCUS</b>							
2.0 16V	2.0	96	10.98–07.04	EDDC/EDDB/EDDD/EDDF	4		ZS 350
ST170	2.0	127	03.02–11.04	ALDA	4		ZS 350
<b>FOCUS II</b>							
1.4	1.4	59	03.05–	ASDB/ASDA	4		ZS 387
1.6	1.6	74	03.05–	SHDA/HWDB/HWDA	4		ZS 387
1.6 LPG	1.6	85	10.09–	SIDA	4		ZS 387
1.6 Ti	1.6	85	03.05–	HXDB/HXDA	4		ZS 387
2.0	2.0	107	11.04–	AODA/AODB	4		ZS 408
2.5 ST	2.5	166	10.05–	HYDA	5		ZSE 055
<b>FOCUS II Cabriolet</b>							
1.6	1.6	74	10.06–10.09	HWDB/HWDA	4		ZS 387
<b>FOCUS II Kombi</b>							
1.4	1.4	59	03.05–	ASDB/ASDA	4		ZS 387
1.6	1.6	74	03.05–	SHDA/HWDB/HWDA	4		ZS 387
1.6 LPG	1.6	85	10.09–	SIDA	4		ZS 387
1.6 Ti	1.6	85	11.04–	HXDB/HXDA	4		ZS 387
2.0	2.0	107	11.04–	AODA/AODB	4		ZS 408
<b>FOCUS III</b>							
1.6 Ti	1.6	77	04.11–	IQDB	4		ZS 387
<b>FOCUS III Kombi</b>							
1.6 Flexifuel	1.6	88	05.11–	MUDA	4		ZS 387
1.6 Ti	1.6	77	05.11–	IQDB	4		ZS 387
1.6 Ti	1.6	92	05.11–	PNDA	4		ZS 387
<b>FUSION</b>							
1.25	1.2	55	03.05–	FUJA/FUJB	4		ZS 387
1.3	1.3	44	11.02–	BAJA	4		ZS 350 <sup>19</sup>
1.4	1.4	59	03.05–	FXJC/FXJB/FXJA	4		ZS 387
1.4 LPG	1.4	59	01.10–06.12	UTJA	4		ZS 387
1.6	1.6	74	08.02–02.05	FYJA/FYJB	4		ZS 350
1.6	1.6	74	03.05–	FYJA/FYJB	4		ZS 387
<b>GALAXY</b>							
2.0 i	2.0	85	01.01–05.06	NSE/ZVSA	4		ZS 422
2.3 16V	2.3	103	09.01–05.06	E5SB	4		ZS 422
2.3 16V	2.3	107	04.00–05.06	Y5B/E5SA	4		ZS 422
2.8 i V6	2.8	128	11.95–04.00	AAA/AMY	6		ZSE 004
2.8 i V6 4x4	2.8	128	04.96–04.00	AAA/AMY	6		ZSE 004
2.8 V6	2.8	150	04.00–05.06	AYL	6		ZSE 089
<b>GRAND C-MAX</b>							
1.6 Ti	1.6	77	12.10–	IQDB/IQDA	4		ZS 387
1.6 Ti	1.6	92	12.10–	PNDA	4		ZS 387
<b>GT</b>							
5.4	5.4	368	06.03–		8		ZS 369
<b>KA</b>							
1.3 i	1.3	36	06.98–09.98	JJH/JJD/JJF/JJL/JJG	4		ZS 237
1.3 i	1.3	36	06.98–09.98	JJH/JJD/JJF/JJL/JJG	4		ZS 281
1.3 i	1.3	36	09.98–11.08	JJH/JJD/JJF/JJL/JJG	4		ZS 350
1.3 i	1.3	37	09.96–09.98	JJB	4		ZS 237 <sup>19</sup>
1.3 i	1.3	37	09.96–09.98	JJB	4		ZS 281 <sup>19</sup>
1.3 i	1.3	37	09.98–10.02	JJB	4		ZS 350 <sup>19</sup>
1.3 i	1.3	44	09.96–08.98	J4S/BAA/J4K/J4M/J4P/J4N/J4D	4		ZS 281 <sup>19</sup>
1.3 i	1.3	44	09.98–11.08	J4S/BAA/J4K/J4M/J4P/J4N/J4D	4		ZS 350 <sup>19</sup>
1.3 i	1.3	51	08.02–02.07	A9B/A9A	4		ZS 350
1.6 i	1.6	70	07.03–07.07	CDC/CDB	4		ZS 350
1.6 i	1.6	70	08.07–11.08	CDC/CDB	4		ZS 387
1.2	1.2	51	10.08–	FP4	4		ZS 079
<b>KUGA</b>							
2.5 4x4	2.5	147	03.09–	DuratecST-Motor	5		ZSE 055
<b>MAVERICK</b>							
2.0 16V	2.0	91	02.01–	YF	4		ZS 350
3.0 V6 24V	3.0	145	02.01–	AJ	6		ZS 410



kW



**FORD**

**MONDEO I**

1.6 i 16V	1.6	65	07.94-08.96	L1J	4	<b>ZS 239</b>
1.6 i 16V	1.6	65	07.94-08.96	L1J	4	<b>ZS 281</b>
1.6 i 16V	1.6	66	02.93-08.96	L1F	4	<b>ZS 239</b>
1.6 i 16V	1.6	66	02.93-08.96	L1F	4	<b>ZS 281</b>
1.8 i 16V	1.8	82	07.94-08.96	RKB	4	<b>ZS 239</b>
1.8 i 16V	1.8	82	07.94-08.96	RKB	4	<b>ZS 281</b>
1.8 i 16V	1.8	85	02.93-08.96	RKA	4	<b>ZS 239</b>
1.8 i 16V	1.8	85	02.93-08.96	RKA	4	<b>ZS 281</b>
1.8 i 16V 4x4	1.8	85	02.93-08.96	RKA	4	<b>ZS 239</b>
1.8 i 16V 4x4	1.8	85	02.93-08.96	RKA	4	<b>ZS 281</b>
2.0 i 16V	2.0	97	12.94-08.96	NGA	4	<b>ZS 239</b>
2.0 i 16V	2.0	100	02.93-08.96	NGA	4	<b>ZS 239</b>
2.0 i 16V	2.0	100	02.93-08.96	NGA	4	<b>ZS 281</b>
2.0 i 16V 4x4	2.0	97	12.94-08.96	NGA	4	<b>ZS 239</b>
2.0 i 16V 4x4	2.0	97	01.95-08.96	NGA	4	<b>ZS 281</b>
2.5 i 24V	2.5	125	07.94-08.96	SEA	6	<b>ZS 371</b>

**MONDEO I Kombi**

1.6 i 16V	1.6	65	07.94-08.96	L1J	4	<b>ZS 239</b>
1.6 i 16V	1.6	65	07.94-08.96	L1J	4	<b>ZS 281</b>
1.6 i 16V	1.6	66	04.93-08.96	L1F	4	<b>ZS 239</b>
1.6 i 16V	1.6	66	04.93-08.96	L1F	4	<b>ZS 281</b>
1.8 i 16V	1.8	82	07.94-08.96	RKB	4	<b>ZS 239</b>
1.8 i 16V	1.8	82	07.94-08.96	RKB	4	<b>ZS 281</b>
1.8 i 16V	1.8	85	04.93-08.96	RKA	4	<b>ZS 239</b>
1.8 i 16V	1.8	85	04.93-08.96	RKA	4	<b>ZS 281</b>
1.8 i 16V 4x4	1.8	85	04.93-08.96	RKA	4	<b>ZS 239</b>
1.8 i 16V 4x4	1.8	85	04.93-08.96	RKA	4	<b>ZS 281</b>
2.0 i 16V	2.0	97	01.93-08.96	NGA	4	<b>ZS 239</b>
2.0 i 16V	2.0	100	04.93-08.96	NGA	4	<b>ZS 239</b>
2.0 i 16V	2.0	100	04.93-08.96	NGA	4	<b>ZS 281</b>
2.0 i 16V 4x4	2.0	97	12.94-08.96	NGA	4	<b>ZS 239</b>
2.0 i 16V 4x4	2.0	97	12.94-08.96	NGA	4	<b>ZS 281</b>
2.0 i 16V 4x4	2.0	100	04.93-08.96	NGA	4	<b>ZS 239</b>
2.0 i 16V 4x4	2.0	100	04.93-08.96	NGA	4	<b>ZS 281</b>
2.5 i 24V	2.5	125	07.94-08.96	SEA	6	<b>ZS 371</b>

**MONDEO II**

1.6 i	1.6	66	09.96-08.98	L1J	4	<b>ZS 281</b>
1.6 i	1.6	66	09.98-11.00	L1J	4	<b>ZS 350</b>
1.6 i 16V	1.6	70	05.98-08.98	L1N/L1L/L1Q	4	<b>ZS 281</b>
1.6 i 16V	1.6	70	09.98-11.00	L1N/L1L/L1Q	4	<b>ZS 350</b>
1.8 i	1.8	85	09.96-08.98	RKK/RKJ/RKB/RKF/RKH	4	<b>ZS 281</b>
1.8 i	1.8	85	09.98-11.00	RKK/RKJ/RKB/RKF/RKH	4	<b>ZS 350</b>
2.0 i	2.0	96	09.96-08.98	NGA/NGB/NGD/NGC	4	<b>ZS 281</b>
2.0 i	2.0	96	09.98-11.00	NGA/NGB/NGD/NGC	4	<b>ZS 350</b>
2.5 24V	2.5	125	09.96-11.00	SEA	6	<b>ZS 371</b>

**MONDEO II Kombi**

1.6 i	1.6	66	09.96-08.98	L1J	4	<b>ZS 281</b>
1.6 i	1.6	66	09.98-11.00	L1J	4	<b>ZS 350</b>
1.6 i 16V	1.6	70	05.98-08.98	L1N/L1L/L1Q	4	<b>ZS 281</b>
1.6 i 16V	1.6	70	09.98-11.00	L1N/L1L/L1Q	4	<b>ZS 350</b>
1.8 i	1.8	85	09.96-08.98	RKK/RKJ/RKB/RKF/RKH	4	<b>ZS 281</b>
1.8 i	1.8	85	09.98-11.00	RKK/RKJ/RKB/RKF/RKH	4	<b>ZS 350</b>
2.0 i	2.0	96	09.96-08.98	NGA/NGB/NGD/NGC	4	<b>ZS 281</b>
2.0 i	2.0	96	09.98-11.00	NGA/NGB/NGD/NGC	4	<b>ZS 350</b>
2.5 24V	2.5	125	09.96-11.00	SEA	6	<b>ZS 371</b>

**MONDEO III**

1.8 16V	1.8	81	11.00-02.05	CGBB/CGBA	4	<b>ZS 422</b>
1.8 16V	1.8	92	11.00-02.05	CHBA/CHBB	4	<b>ZS 422</b>
1.8 SCi	1.8	96	06.03-02.05	CFBA	4	<b>ZS 422</b>
2.0 16V	2.0	107	11.00-02.05	CJBA/CJBB	4	<b>ZS 422</b>
2.5 V6 24V	2.5	125	11.00-08.07	LCBD	6	<b>ZS 372</b>

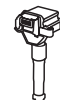

kW

**FORD****MONDEO III Kombi**

1.8 16V	1.8	81	11.00-02.05	CGBB/CGBA	4		<b>ZS 422</b>
1.8 16V	1.8	92	11.00-02.05	CHBA/CHBB	4		<b>ZS 422</b>
1.8 SCi	1.8	96	06.03-02.05	CFBA	4		<b>ZS 422</b>
2.0 16V	2.0	107	11.00-02.05	CJBA/CJBB	4		<b>ZS 422</b>
2.5 V6 24V	2.5	125	11.00-08.07	LCBD	6		<b>ZS 372</b>

**MONDEO IV**

1.6 Ti	1.6	81	03.07-08.10	RHBA	4		<b>ZS 387</b>
1.6 Ti	1.6	88	07.10-08.10		4		<b>ZS 387</b>
1.6 Ti	1.6	92	03.07-08.10	PNBA	4		<b>ZS 387</b>
2.0	2.0	107	03.07-	AOBC/AOBA/TBBA	4		<b>ZS 408</b>
2.5	2.5	162	03.07-	HUBA	5		<b>ZSE 055</b>

**MONDEO IV Kombi**

1.6 Ti	1.6	81	03.07-08.10	RHBA	4		<b>ZS 387</b>
1.6 Ti	1.6	88	07.10-		4		<b>ZS 387</b>
1.6 Ti	1.6	92	03.07-08.10	PNBA	4		<b>ZS 387</b>
2.0	2.0	107	03.07-	AOBC/AOBA/TBBA	4		<b>ZS 408</b>
2.5	2.5	162	03.07-	HUBA	5		<b>ZSE 055</b>

**ORION I**

1.3	1.3	51	02.85-03.86	JPA	4	<b>ZM 003</b>	
1.3	1.3	51	09.83-03.86	JPA	4	<b>ZM 008</b>	
1.3	1.3	51	08.84-03.86	JPA	4	<b>ZM 020</b>	
1.3	1.3	51	09.83-12.85	JPA	4		<b>ZS 126</b>
1.6	1.6	58	02.85-03.86	LP1/LPA	4	<b>ZM 003</b>	
1.6	1.6	58	09.83-03.86	LP1/LPA	4	<b>ZM 008</b>	
1.6	1.6	58	08.84-03.86	LP1/LPA	4	<b>ZM 020</b>	
1.6	1.6	58	09.83-12.85	LP1/LPA	4		<b>ZS 126</b>
1.6 i	1.6	77	02.85-03.86	LRA/LR1	4	<b>ZM 003</b>	
1.6 i	1.6	77	09.83-03.86	LRA/LR1	4	<b>ZM 008</b>	
1.6 i	1.6	77	09.85-03.86	LRA/LR1	4	<b>ZM 015</b>	
1.6 i	1.6	77	09.83-12.85	LRA/LR1	4		<b>ZS 126</b>

**ORION II**

1.3	1.3	44	03.86-07.90	JLA/JBB/JLB	4	<b>ZM 003</b>	<b>ZS 238</b>
1.3	1.3	44	03.86-07.90	JLA/JBB/JLB	4	<b>ZM 003</b>	<b>ZS 281</b>
1.3	1.3	51	11.86-07.88	JPA	4	<b>ZM 003</b>	
1.3	1.3	51	11.86-07.88	CVH	4	<b>ZM 020</b>	
1.4	1.4	52	03.86-07.90	CVH	4	<b>ZM 020</b>	
1.4	1.4	52	10.87-07.90	FUAA	4	<b>ZM 003</b>	<b>ZS 126</b>
1.4	1.4	54	01.86-07.90	CVH	4	<b>ZM 020</b>	
1.4	1.4	54	02.87-07.90	FUC	4	<b>ZM 003</b>	<b>ZS 126</b>
1.4	1.4	55	12.85-07.90	CVH	4	<b>ZM 020</b>	
1.4	1.4	55	04.86-07.90	FUA	4	<b>ZM 003</b>	<b>ZS 126</b>
1.4 KAT	1.4	54	02.87-07.90	CVH	4	<b>ZM 020</b>	
1.4 KAT	1.4	54	10.87-07.90	F6D/F6B	4	<b>ZM 003</b>	<b>ZS 126</b>
1.6	1.6	66	12.85-07.90	LUC	4	<b>ZM 003</b>	<b>ZS 126</b>
1.6	1.6	66	12.85-07.90	CVH	4	<b>ZM 020</b>	<b>ZS 126</b>
1.6	1.6	66	03.89-07.90	LUC	4		<b>ZS 281</b>
1.6 i	1.6	75	08.89-07.90	CVH	4	<b>ZM 020</b>	
1.6 i	1.6	75	08.89-07.90	LJB	4		<b>ZS 281</b>
1.6 i	1.6	77	03.86-07.90	LRB	4	<b>ZM 003</b>	<b>ZS 126</b>
1.6 i	1.6	77	03.86-07.90	LRB	4	<b>ZM 015</b>	<b>ZS 126</b>
1.6 i KAT	1.6	66	03.86-07.90	L4B	4	<b>ZM 003</b>	
1.6 i KAT	1.6	66	03.86-07.90	CVH	4	<b>ZM 020</b>	

**ORION III**

1.3	1.3	44	07.90-12.93	J6A/J4B	4		<b>ZS 237</b>
1.3	1.3	44	07.90-12.93	J6A/J4B	4		<b>ZS 238</b>
1.3	1.3	44	07.90-12.93	J6A/J4B	4		<b>ZS 281</b>
1.4	1.4	52	07.90-12.93	F6F/F6G	4		<b>ZS 126</b>
1.4	1.4	54	07.90-12.93	FUH	4		<b>ZS 126</b>
1.4	1.4	54	07.90-12.93	FUH	4		<b>ZS 281</b>
1.6	1.6	66	07.90-12.92	LUJ/LUK	4		<b>ZS 126</b>
1.6	1.6	66	07.90-12.92	LUJ/LUK	4		<b>ZS 281</b>



kW



**FORD**

**ORION III**

1.6 i	1.6	77	07.90-09.92	LJF	4		ZS 281
1.6 i 16V	1.6	66	07.92-12.93	L1E/L1K	4		ZS 239
1.6 i 16V	1.6	66	07.92-12.93	L1E/L1K	4		ZS 281
1.8 i 16V	1.8	77	02.92-12.93	RDA	4		ZS 239
1.8 i 16V	1.8	77	02.92-12.93	RDA	4		ZS 281
1.8 i 16V	1.8	96	01.92-07.93	RQB	4		ZS 281
1.8 i 16V	1.8	96	01.92-12.93	RQB	4		ZS 239

**PUMA**

1.4 16V	1.4	66	11.97-04.98	FHD/FHF	4		ZS 281
1.4 16V	1.4	66	05.98-10.00	FHD/FHF	4		ZS 350
1.7 16V	1.7	92	03.97-04.98	MHB/MHA	4		ZS 281
1.7 16V	1.7	92	05.98-06.02	MHB/MHA	4		ZS 350

**SCORPIO I**

1.8	1.8	66	04.85-02.92	REC	4		ZS 126
2.0	2.0	77	04.85-07.87	N8D/NEL	4	ZM 019	
2.0	2.0	77	04.85-08.89	N8D/NEL	4		ZS 126
2.0	2.0	80	05.89-01.92	N8A	4		ZS 126
2.0 i	2.0	74	10.85-07.87	NRC	4	ZM 019	
2.0 i	2.0	74	10.85-12.90	NRC	4		ZS 126
2.0 i	2.0	85	04.85-02.92	NRI/NRA	4		ZS 126
2.0 i	2.0	85	04.85-07.87	NRI/NRA	4	ZM 019	
2.0 i	2.0	85	02.92-07.94	NRI/NRA	4		ZS 126
2.0 i	2.0	88	05.89-01.92	N9D	4		ZS 126
2.4 i	2.4	92	10.88-02.92	ARD	6		ZS 126
2.4 i	2.4	92	10.88-07.89	ARD	6	ZM 019	
2.4 i	2.4	96	09.86-09.88	ARC	6	ZM 019	ZS 126
2.4 i KAT	2.4	92	10.88-01.92	ARD	6		ZS 126
2.4 i KAT	2.4	92	10.88-07.89	ARD	6	ZM 019	
2.8 i	2.8	110	04.85-11.86	PRE	6	ZM 019	ZS 126
2.8 i 4x4	2.8	110	10.85-11.86	PRE	6	ZM 019	ZS 126
2.9 i	2.9	107	09.86-09.94	BRD/BRE/BRF	6	ZM 019	ZS 126
2.9 i	2.9	110	09.86-01.92	BRC	6		ZS 126
2.9 i	2.9	110	09.86-09.94	BRC	6	ZM 019	
2.9 i 24V	2.9	143	04.91-09.94	BOA	6	ZM 019	ZS 371
2.9 i 4x4	2.9	107	05.88-02.93	BRD/BRE/BRF	6	ZM 019	
2.9 i 4x4	2.9	107	02.92-02.93	BRD/BRE/BRF	6		ZS 126
2.9 i 4x4	2.9	110	09.86-01.92	BRC	6		ZS 126
2.9 i 4x4	2.9	110	09.86-09.94	BRC	6	ZM 019	
2.9 i KAT	2.9	107	10.87-01.92	BRE	6		ZS 126
2.9 i KAT	2.9	107	10.87-09.94	BRE	6	ZM 019	

**SCORPIO I Kombi**

2.0 i	2.0	85	02.92-07.94	N9F	4		ZS 126
2.0 i	2.0	88	09.91-01.92	N9D	4		ZS 126
2.4 i	2.4	92	09.91-01.92	ARD	6		ZS 126
2.9 24V	2.9	143	08.93-09.94	BOA	6		ZS 126
2.9 24V	2.9	143	08.93-09.94	BOA	6		ZS 371
2.9 i	2.9	107	09.91-01.92	BRD/BRE/BRF	6		ZS 126
2.9 i	2.9	107	09.91-09.94	BRD/BRE/BRF	6	ZM 019	
2.9 i 4x4	2.9	107	05.88-07.89	BRD/BRE/BRF	6	ZM 019	

**SCORPIO II**

2.0 i 16V	2.0	100	10.94-04.96	N3A	4		ZS 308
2.3 i 16V	2.3	108	06.96-08.98	Y5A	4		ZS 308
2.9 i	2.9	110	02.95-08.96	BRG	6	ZM 019	ZS 126
2.9 i 24V	2.9	152	10.94-08.98	BOB	6	ZM 019	

**SCORPIO II Kombi**

2.0 i 16V	2.0	100	10.94-04.96	N3A	4		ZS 308
2.3 i 16V	2.3	108	06.96-08.98	Y5A	4		ZS 308
2.9 i	2.9	110	02.95-08.96	BRG	6	ZM 019	ZS 126
2.9 i 24V	2.9	152	10.94-08.98	BOB	6	ZM 019	



kW



## FORD

## SIERRA

1.6	1.6	53	01.88–02.93	LSF	4		ZS 126
1.8	1.8	59	10.87–05.88	RED/REF	4		ZS 126
1.8	1.8	64	05.88–02.93	R2C	4		ZS 126
1.8	1.8	64	05.88–02.93	R2C/R6A	4		ZS 281
1.8	1.8	66	01.87–05.88	RED/R2A	4		ZS 126
2.0	2.0	77	01.87–02.93	N8C/NES	4		ZS 126
2.0 4x4	2.0	88	01.90–02.93	N9C	4		ZS 126
2.0 4x4	2.0	92	01.90–02.93	N9C	4		ZS 126
2.0 i	2.0	74	10.87–12.89	NE5/NEJ	4		ZS 126
2.0 i	2.0	85	01.87–02.93	N4I/N4A	4		ZS 126
2.0 i	2.0	88	01.90–02.93	N9C	4		ZS 126
2.0 i DOHC	2.0	85	12.91–02.93	N9E	4		ZS 126
2.0 i KAT	2.0	74	01.87–02.93	N4B	4		ZS 126
2.8 i	2.8	105	08.87–12.88	PR8	6		ZS 126
2.9 4x4	2.9	107	08.88–02.93	B4B/B4C	6		ZS 126
2.9 i	2.9	107	08.88–02.93	B4B/B4C	6		ZS 126
2.9 i	2.9	110	08.88–02.93	B4B/B4C	6		ZS 126

## SIERRA Kombi

1.6	1.6	53	01.88–02.93	LSF	4		ZS 126
1.6	1.6	55	01.87–02.93	LSE	4		ZS 126
1.8	1.8	59	10.87–05.88	RED/REF	4		ZS 126
1.8	1.8	64	05.88–02.93	R2C	4		ZS 126
1.8	1.8	64	05.88–02.93	R2C/R6A	4		ZS 281
1.8	1.8	66	10.84–12.86	REB	4		ZS 126
1.8	1.8	66	01.87–05.88	RED/R2A	4		ZS 126
2.0	2.0	66	08.82–10.84	NYT	6		ZS 126
2.0	2.0	77	08.82–12.86	NET	4		ZS 126
2.0	2.0	77	01.87–02.93	N8C/NES	4		ZS 126
2.0	2.0	85	03.85–12.86	NR2/NRB	4		ZS 126
2.0 4x4	2.0	88	02.90–02.93	N9C	4		ZS 126
2.0 4x4	2.0	92	05.89–02.93	N9C	4		ZS 126
2.0 i	2.0	74	01.87–02.93	NE5/NEJ	4		ZS 126
2.0 i	2.0	85	01.87–02.93	N4I/N4A	4		ZS 126
2.0 i	2.0	88	05.89–02.93	N9C	4		ZS 126
2.0 i	2.0	92	05.89–02.93	N9C	4		ZS 126
2.0 i DOHC	2.0	85	12.91–02.93	N9E	4		ZS 126
2.0 i KAT	2.0	74	01.87–02.93	N4B	4		ZS 126
2.3	2.3	84	08.82–12.86	YYT	6		ZS 126
2.8 4x4	2.8	110	01.87–08.88	PRG	6	ZM 019	ZS 126
2.8 i 4x4	2.8	105	08.82–12.86	PR6	6		ZS 126
2.8 i 4x4	2.8	107	01.87–12.88	PR7	6		ZS 126
2.8 XR4i	2.8	105	08.82–12.86	PR6	6		ZS 126
2.8 XR4i	2.8	107	08.82–12.86	PR5	6		ZS 126
2.9	2.9	107	08.88–02.93	B4B/B4C	6	ZM 019	ZS 126
2.9 4x4	2.9	107	08.88–02.93	B4B/B4C	6	ZM 019	ZS 126
2.9 i	2.9	110	08.88–02.93	B4B/B4C	6		ZS 126

## S-MAX

2.0	2.0	107	05.06–	AOWB/AOWA	4		ZS 408
2.5 ST	2.5	162	05.06–	HUWA	5		ZSE 055

## STREET KA

1.6	1.6	70	05.03–07.05	CDRA/CDRB	4		ZS 350 <sup>19</sup>
-----	-----	----	-------------	-----------	---	--	----------------------



## COURIER Kasten (F3L, F5L)

1.3	1.3	44	09.91–02.96	J6B	4		ZS 238
1.3	1.3	44	01.92–02.96	J6B	4		ZS 281

## COURIER Kasten (J5\_, J3\_)

1.3	1.3	44	02.96–08.98	J4C	4		ZS 281 <sup>19</sup>
1.3	1.3	44	09.98–	J4C	4		ZS 350 <sup>19</sup>
1.4 i	1.4	66	04.96–10.99	FHA	4		ZS 281





kW



**FORD**



**TOURNEO CONNECT**

1.8 16V	1.8	85	06.02–	EYPC/EYPA/EYPD	4		<b>ZS 365</b>	
<b>TRANSIT Bus (V_ )</b>								
2.0	2.0	55	08.83–12.85	4RC	4		<b>ZS 126</b>	
2.0	2.0	57	08.83–12.85	4RC	4		<b>ZS 126</b>	
<b>TRANSIT Bus (T_ )</b>								
1.6	1.6	46	12.85–01.89	LAT	4		<b>ZS 126</b>	
2.0	2.0	57	10.88–07.91	N6T	4		<b>ZS 126</b>	
2.0	2.0	57	01.86–07.91	NAT/NAV	4		<b>ZS 126</b>	
<b>TRANSIT Bus (E_ )</b>								
2.0	2.0	66	09.91–09.94	NBA	4		<b>ZS 126</b>	
2.0 i	2.0	72	09.91–07.94	NCA	4		<b>ZS 126</b>	
2.9 i	2.9	107	08.91–07.94	BRT	6		<b>ZS 126</b>	
<b>TRANSIT Bus (FD_ , FB_ , FS_ , FZ_ , FC_ )</b>								
2.3 16V [RWD]	2.3	107	08.00–05.06	E5FC/E5FA	4		<b>ZS 308</b>	
<b>TRANSIT CONNECT (P65_ , P70_ , P80_ )</b>								
1.8 16V	1.8	85	06.02–	EYPC/EYPA/EYPD	4		<b>ZS 365</b>	
1.8 16V LPG	1.8	85	06.02–	EYPC	4		<b>ZS 281</b>	

**FORD USA**

**ESCORT Stufenheck**

1.6 i	1.6	70	01.01–08.02	L1K	4		<b>ZS 281</b>	
<b>EXPLORER (U2)</b>								
4.0	4.0	115	11.94–08.96		6		<b>ZS 370</b>	
4.0	4.0	150	10.99–04.03	99X	6		<b>ZS 370</b>	
4.0	4.0	152	09.96–08.02		6		<b>ZS 370</b>	
4.0 Allrad	4.0	150	10.99–04.03	99X	6		<b>ZS 370</b>	
4.0 V6 Allrad	4.0	115	03.95–		6		<b>ZS 370</b>	
4.0 V6 Allrad	4.0	121	01.93–		6		<b>ZS 370</b>	
<b>MUSTANG</b>								
4.0 V6	4.0	157	12.04–		6		<b>ZS 370</b>	
5.4 V8	5.4	355	01.06–		8		<b>ZS 369</b>	
<b>TAURUS (P5_ )</b>								
3.0	3.0	108	09.96–12.99		6		<b>ZS 366</b>	
3.0 24V	3.0	149	09.96–12.99		6		<b>ZS 366</b>	
<b>WINDSTAR (A3)</b>								
3.0 V6	3.0	109	03.95–02.99		6		<b>ZS 371</b>	

**FSO**

**125P**

1.5	1.5	55	10.67–08.92	115 C 076	4		<b>ZM 005</b>	
<b>POLONEZ I</b>								
1.5	1.5	55	10.77–08.88	AA	4		<b>ZS 106</b>	
1.5	1.5	55	01.83–12.86	AA	4		<b>ZM 005</b>	
1.5	1.5	60	01.78–08.88		4		<b>ZS 106</b>	
1.5	1.5	60	01.83–12.86		4		<b>ZM 005</b>	
1.6	1.6	64	08.86–08.88	CB	4		<b>ZM 005 ZS 106</b>	
<b>POLONEZ III</b>								
1.6 i	1.6	57	09.92–03.02		4		<b>ZS 234</b>	

**HONDA**

**ACCORD II**

1.6 EX	1.6	65	09.83–10.85	EZ	4		<b>ZM 016 ZS 106</b>	
1.8 EX	1.8	74	09.83–10.85	ET1	4		<b>ZM 016</b>	
<b>ACCORD III</b>								
1.6 L	1.6	65	11.85–12.89	A16A1	4		<b>ZM 056</b>	
2.0 EX	2.0	75	01.86–12.89	A20A1	4		<b>ZM 056</b>	
2.0 EX	2.0	76	01.86–12.89	A20A1	4		<b>ZM 056</b>	



kW

**HONDA****ACCORD III**

2.0 EX	2.0	78	01.86–05.89	A20A2	4	ZM 056	
2.0 EXi	2.0	85	01.86–12.89	A20A3	4	ZM 056	
2.0 EXi	2.0	90	11.85–12.87	A20A4	4	ZM 056	
2.0 i 16V	2.0	98	10.87–12.89	B20A8	4	ZM 016	
2.0 i 16V	2.0	101	01.87–12.87	B20A2	4	ZM 016	

**ACCORD IV**

2.0 16V	2.0	81	01.90–03.93	F20A3/F20A2	4		ZS 275
2.0 i 16V	2.0	98	01.90–03.93	F20A4/F20A8	4		ZS 275
2.2 i 16V	2.2	110	01.90–03.93	F22A3	4		ZS 275 <sup>202</sup>
2.2 i 16V	2.2	110	01.90–03.93	F22A3	4		ZS 419 <sup>202</sup>

**ACCORD IV Aerodeck**

2.0 i 16V	2.0	98	03.93–12.93	F20Z3	4	ZM 023	
2.0 i 16V	2.0	98	03.93–12.93	F20Z3	4		ZS 275
2.2 i 16V	2.2	110	01.91–12.93	F22A7	4		ZS 275

**ACCORD IV Coupe**

2.0 i 16V	2.0	98	01.92–09.93	F20A7	4		ZS 275
-----------	-----	----	-------------	-------	---	--	--------

**ACCORD V**

2.0 i	2.0	85	03.93–01.96	F20Z2	4	ZM 023	
2.0 i	2.0	85	03.93–01.96	F20Z2	4		ZS 275
2.0 i S	2.0	96	03.93–01.96	F20Z1	4	ZM 023	
2.0 i S	2.0	96	03.93–01.96	F20Z1	4		ZS 275
2.3 i SR	2.3	116	03.93–01.96	H23A3	4		ZS 275

**ACCORD V Aerodeck**

2.0 i LS 16V	2.0	100	09.93–02.98	F20B3	4		ZS 275
2.2 i ES	2.2	110	09.93–02.98	F22B5	4		ZS 275

**ACCORD V Coupe**

2.2 i ES	2.2	110	09.93–02.98	F22B5	4		ZS 275
----------	-----	-----	-------------	-------	---	--	--------

**ACCORD VI**

1.9 i	1.9	85	02.96–10.98	F18A3	4		ZS 532
2.0 i LS	2.0	96	02.96–10.98	F20Z1	4		ZS 532
2.2 i VTEC	2.2	110	02.96–10.98	F22Z2	4		ZS 532

**ACCORD VII**

1.8 i	1.9	100	10.98–12.02	F18B2	4	ZM 045	ZS 532
2.0 i	2.0	108	10.98–01.01	F20B6	4		ZS 532
2.2 Type-R	2.2	156	02.99–12.02	H22A7	4		ZS 275
2.3	2.3	113	01.01–06.03	F23Z5/F23A1	4		ZS 532

**CIVIC I**

1300 S	1.3	52	10.79–12.84	EN4	4	ZM 054	
--------	-----	----	-------------	-----	---	--------	--

**CIVIC II**

1.5 i 16V	1.5	69	01.88–08.89	D15B2	4	ZM 023	
1.5 i 16V	1.5	69	01.88–11.91	D15B2	4		ZS 276
1.6 i 16V 4WD	1.6	80	01.88–12.89	D16A6	4	ZM 023	ZS 276
1.6 i 16V 4WD	1.6	81	01.88–02.95	D16A6	4		ZS 276
1.6 i 16V 4WD	1.6	81	01.88–08.92	D16A6	4	ZM 023	

**CIVIC III**

1.2	1.2	40	01.84–10.87	ZA2/D12B1	4	ZM 056	
1.3	1.3	52	01.84–10.87	EV2	4	ZM 056	
1.5 GL	1.5	63	10.83–10.87	EW2	4	ZM 056	
1.5 GT	1.5	74	01.85–10.87	EW3	4	ZM 056	
1.5 GTi	1.5	66	03.86–10.87	EW4	4	ZM 056	

**CIVIC IV**

1.5 i 16V	1.5	66	10.88–09.91	D15B2	4		ZS 278
1.5 i 16V	1.5	69	10.88–09.91	D15B2	4	ZM 023	ZS 278
1.6 i 16V	1.6	80	10.87–09.91	D16A6	4	ZM 023	
1.6 i 16V	1.6	80	01.89–12.89	D16A6	4		ZS 276
1.6 i 16V	1.6	81	10.87–09.91	D16Z2	4	ZM 023	ZS 278
1.6 i 16V	1.6	96	09.87–09.91	D16A9/D16A7	4	ZM 023	
1.6 i 16V Vtec	1.6	110	10.89–09.91	B16A1	4	ZM 023	ZS 276

**CIVIC V**

1.3 16V	1.3	55	10.91–11.95	D13B2	4		ZS 275
1.5 i 16V	1.5	66	10.91–11.95	D15Z2	4		ZS 275

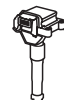

kW

**HONDA****CIVIC V**

1.5 i 16V	1.5	69	01.93-11.95	D15Z1 /D15B2	4	ZM 045	
1.5 i 16V	1.5	69	10.91-11.95	D15Z1 /D15B2	4		ZS 275
1.5 i LSi	1.5	74	01.94-11.95	D15B7	4		ZS 275
1.6 16V Vtec	1.6	92	01.93-11.95	D16Z6	4	ZM 045	
1.6 16V Vtec	1.6	92	01.92-12.93	D16Z6	4		ZS 275
1.6 VTi 16V	1.6	118	01.92-12.93	B16A2	4		ZS 275
1.6 VTi 16V	1.6	118	01.93-11.95	B16A2	4	ZM 045	

**CIVIC VI**

1.4 i	1.4	55	01.96-02.01	D14A5/D14A7	4		ZS 532
1.4 i	1.4	66	01.96-01.97	D14A8/D14A2	4		ZS 532
1.4 i S	1.4	66	11.95-02.01	D14A4/D14Z2	4		ZS 275
1.5 i	1.5	84	11.95-02.01	D15Z6	4		ZS 275
1.5 16V	1.5	84	01.97-02.01	D15Z8	4		ZS 532
1.5 i Vtec-E	1.5	66	09.94-01.97	D15Z3	4	ZM 045	ZS 275
1.6 16V	1.6	85	01.97-02.01	D16B2	4		ZS 275
1.6 i	1.6	77	03.96-03.00	D16Y7	4		ZS 275
1.6 i	1.6	83	09.94-01.97	D16Y3	4	ZM 045	
1.6 i	1.6	83	01.96-01.97	D16Y3	4		ZS 532
1.6 i Vtec	1.6	93	09.94-01.97	D16Y2	4	ZM 045	ZS 275
1.6 VTi	1.6	118	01.97-02.01	B16A2	4		ZS 275

**CONCERTO**

1.5 i 16V	1.5	66	08.89-03.95	D15B2	4		ZS 278
1.5 i 16V	1.5	66	08.89-08.92	D15B2	4	ZM 023	
1.6 i 16V	1.6	82	08.89-03.95	D16Z2	4		ZS 276
1.6 i 16V	1.6	82	08.89-08.92	D16Z2	4	ZM 023	
1.6 i 16V	1.6	90	08.89-03.95	D16A8	4		ZS 276
1.6 i 16V	1.6	90	08.89-08.92	D16A8	4	ZM 023	

**CR-V I**

2.0 16V	2.0	94	10.95-01.99	B20B	4		ZS 275
2.0 16V	2.0	108	01.99-02.02	B20Z1	4		ZS 275

**CRX I**

1.5 i	1.5	74	08.84-11.86	EW3	4	ZM 016	
1.6 i 16V	1.6	92	03.86-10.87	ZC1	4	ZM 016	

**CRX II**

1.6 i 16V	1.6	91	10.87-02.92	D16Z5	4		ZS 276
1.6 i 16V	1.6	91	10.87-08.89	D16Z5	4	ZM 023	
1.6 i 16V	1.6	96	10.87-12.89	D16A8/D16A9	4	ZM 023	ZS 276
1.6 i 16V Vtec	1.6	110	10.89-02.92	B16A1	4		ZS 276

**CRX III**

1.6 ESi	1.6	92	03.92-12.98	D16Y8/D16Z6	4		ZS 275
1.6 i VTi	1.6	118	03.92-12.98	B16A2	4		ZS 275

**HR-V**

1.6 16V	1.6	77	03.99-	D16W1	4		ZS 275
1.6 16V 4WD	1.6	77	03.99-12.05	D16W1	4		ZS 275
1.6 16V 4WD	1.6	91	10.99-12.05	D16W5	4		ZS 275

**INTEGRA Coupe**

1.8 Type-R	1.8	140	11.97-10.01	B18C6	4		ZS 275
------------	-----	-----	-------------	-------	---	--	--------

**LOGO**

1.3	1.3	48	03.99-03.02	D13B7	4		ZS 275
-----	-----	----	-------------	-------	---	--	--------

**PRELUDE II**

1.8 EX	1.8	74	11.85-04.87	ET3/ET4	4	ZM 016	
1.8 EX	1.8	74	11.85-04.87	ET3/ET4	4		ZS 417
1.8 EX	1.8	77	11.83-04.87	ET3/ET2	4		ZS 417
1.8 EX	1.8	77	11.83-12.85	ET3/ET2	4	ZM 054	

**PRELUDE III**

2.0	2.0	84	08.87-01.92	B20A4	4	ZM 055	ZS 275
2.0 EX	2.0	80	04.87-01.92	B20A3	4	ZM 056	ZS 275
2.0 i EX 16V	2.0	101	04.86-08.87	B20A1	4	ZM 016	ZS 275
2.0 i EX 16V	2.0	110	10.87-12.90	B20A7	4		ZS 275
2.0 i EX 16V	2.0	101	04.87-12.87	B20A1	4	ZM 055	
2.0 i EX 16V	2.0	101	04.86-12.87	B20A1	4		ZS 275

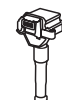

kW

**HONDA**
**PRELUDE III**

2.0 i EX 16V	2.0	101	04.87–01.92	B20A5	4	ZM 055	ZS 275
2.0 i EX 16V	2.0	103	04.90–01.92	B20A9	4	ZM 055	ZS 275

**PRELUDE IV**

2.0 i 16V	2.0	98	02.92–09.96	F20A4	4		ZS 275
2.2 i 16V Vtec	2.2	136	02.93–09.96	H22A2	4		ZS 275
2.3 i 16V	2.3	118	02.92–09.96	H23A2	4		ZS 275

**PRELUDE V**

2.0 16V	2.0	98	10.96–10.00	F20A4	4		ZS 275
2.2 16V	2.2	136	10.96–10.00	H22A5	4		ZS 275

**QUINTET**

1.6 EX	1.6	59	02.80–12.84	EL	4	ZM 054	
--------	-----	----	-------------	----	---	--------	--

**HUMMER**
**HUMMER H3**

3.7 Allrad	3.7	180	09.06–	LLR	5		ZSE 133
------------	-----	-----	--------	-----	---	--	---------

**HYUNDAI**
**ACCENT I**

1.3	1.3	44	10.94–01.00	G4EH	4		ZS 264
1.3	1.3	55	10.94–01.00	G4EH	4		ZS 264
1.3 i 12V	1.3	62	10.94–01.00	G4EH	4		ZS 264
1.5 i 12V	1.5	65	10.94–01.00	G4EK	4		ZS 264

**ATOS**

1.0 i	1.0	40	02.98–08.00	G4HC	4		ZSE 011
1.0 i	1.0	40	08.00–03.02	G4HC D3	4		ZS 266
1.0 i	1.0	43	03.01–	G4HC-E D4	4		ZS 266
1.1	1.1	46	03.04–05.05	G4HG	4		ZSE 011

**ATOS PRIME**

1.0 i	1.0	40	08.99–08.00	G4HC	4		ZSE 011
1.0 i	1.0	40	08.00–	G4HC D3	4		ZS 266
1.0 i	1.0	43	03.01–	G4HC-E D4	4		ZS 266
1.1	1.1	43	06.03–	G4HD	4		ZS 266

**COUPE**

1.6 i 16V	1.6	84	12.96–12.00	4G61	4		ZS 267
2.0 16V	2.0	102	08.96–12.00	G4GF	4		ZS 267

**ELANTRA**

2.0 CVT	2.0	105	06.06–06.11	G4GC	4		ZSE 502
---------	-----	-----	-------------	------	---	--	---------

**GALLOPER II**

3.0 V6	3.0	104	08.98–12.03	G6AT	6		ZS 511
--------	-----	-----	-------------	------	---	--	--------

**GETZ**

1.3	1.3	63	09.03–09.05	G4EA	4		ZSE 502
1.4 i	1.4	71	08.05–06.09	G4EE	4		ZS 267

**i10**

1.2	1.2	57	11.08–	G4LA	4		ZS 536
1.2	1.2	63	04.11–	G4LA	4		ZS 536

**i20**

1.2	1.2	57	09.08–	G4LA	4		ZS 536
1.2	1.2	63	03.12–	G4LA	4		ZS 536

**LANTRA I**

1.5 i.e.	1.5	63	10.90–11.95	G15B/G4DJ	4		ZS 263
----------	-----	----	-------------	-----------	---	--	--------

**LANTRA II**

1.6 16V	1.6	84	11.95–09.00	4G61	4		ZS 267
1.8 16V	1.8	94	11.95–09.00	G4GM	4		ZS 267
2.0 16V	2.0	102	08.96–09.00	G4GF	4		ZS 267

**MATRIX**

1.6	1.6	76	06.01–08.10	G4ED-G	4		ZS 267
-----	-----	----	-------------	--------	---	--	--------

**PONY**

1.3	1.3	43	10.89–01.95	G4DG	4		ZS 263
-----	-----	----	-------------	------	---	--	--------



kW

**HYUNDAI****PONY**

1.5	1.5	53	10.89–01.95	G15B/G4DJ	4	ZM 035	ZS 263
1.5 i	1.5	61	10.89–01.95	G15B/G4DJ	4		ZS 263
1.5 i	1.5	62	10.89–01.95	G15B/G4DJ	4		ZS 263

**S COUPE**

1.5 i	1.5	62	02.90–05.96	G15B/G4DJ	4		ZS 263
1.5 i	1.5	62	01.93–12.94	G 4 D J	4	ZM 049	
1.5 i	1.5	65	04.92–05.96	G4EK	4	ZM 049	
1.5 i Turbo	1.5	85	04.91–05.96	G4EK-TC	4	ZM 049	

**SANTA FÉ I**

2.0	2.0	99	08.01–03.06	G4BP	4		ZSE 502
2.4 16V	2.4	100	02.01–03.06	G4JS-G	4		ZSE 502
2.4 16V	2.4	107	02.01–12.05	G4JS-G	4		ZSE 502
2.4 16V 4x4	2.4	100	02.01–03.06	G4JS-G	4		ZSE 502
2.4 16V 4x4	2.4	107	02.01–03.06	G4JS-G	4		ZSE 502

**SANTAMO**

2.0 16V	2.0	102	05.99–		4		ZS 521
2.0 16V 4x4	2.0	102	05.99–	G4CP	4		ZS 521

**SONATA II**

2.0 i 16V	2.0	96	01.91–10.93	G4CP-D	4		ZS 261
3.0 i V6	3.0	107	01.91–10.93	G6AT	6	ZM 049	

**SONATA III**

2.0 i	2.0	77	06.94–08.96	G4CP	4		ZS 261
2.0 i 16V	2.0	92	06.96–06.98	G4CP-DM	4		ZS 261
2.0 i 16V	2.0	102	05.93–06.98	G4CP-D	4		ZS 521

**SONATA IV**

2.0 16V	2.0	100	06.98–10.01	G4JP-G	4		ZSE 502
2.0 16V	2.0	96	10.01–11.04	G4JP-EG	4		ZSE 502
2.5 V6 24V	2.5	118	06.98–10.01	G6BV-G	6		ZS 269
2.7 V6	2.7	127	10.01–11.04	G6BA-G	6		ZS 269

**TIBURON Coupe**

2.0 CVT	2.0	105	10.06–	G4GC	4		ZSE 502
---------	-----	-----	--------	------	---	--	---------

**TRAJET**

2.0	2.0	100	03.00–07.08	G4JP-G	4		ZSE 502
2.0	2.0	103	01.04–07.08	G4GC-G	4		ZSE 502
2.0	2.0	104	11.03–07.08	G4GC	4		ZSE 502
2.7 V6	2.7	127	09.00–07.08	G6BA-G	6		ZS 522

**TUCSON**

2.0	2.0	104	08.04–03.10	G4GC	4		ZS 502 <sup>202</sup>
-----	-----	-----	-------------	------	---	--	-----------------------

**XG**

30/300	3.0	138	12.98–	G6CT-G	6		ZSE 086
350	3.5	145	04.03–	G6CU	6		ZSE 086
350	3.5	145	04.03–	G6CU	6		ZSE 087

**H-1**

2.4	2.4	82	06.97–04.04	G4CS	4		ZS 261
-----	-----	----	-------------	------	---	--	--------

**H100**

2.4	2.4	90	07.93–03.00	G4CS	4		ZS 261
-----	-----	----	-------------	------	---	--	--------

**INFINITI****FX**

3.5	3.5	206	02.03–	VQ35DE	6		ZSE 132
35	3.5	206	01.03–	VQ35DE	6		ZSE 132

**G Stufenheck**

35	3.5	191	10.02–	VQ35DE	6		ZSE 132
----	-----	-----	--------	--------	---	--	---------

**G20**

2.0	2.0	85	01.90–12.97	SR20DE	4	ZM 048	ZS 269
-----	-----	----	-------------	--------	---	--------	--------

**I30**

3.0	3.0	142	01.97–	VQ30DE	6		ZSE 071 <sup>202</sup>
3.0	3.0	142	01.97–	VQ30DE	6		ZSE 073 <sup>202</sup>
3.0	3.0	142	01.97–	VQ30DE	6		ZSE 075 <sup>202</sup>



kW



## INFINITI

## I30

3.0	3.0	142	01.97–	VQ30DE	6		ZSE 077 <sup>202</sup>	
3.0	3.0	142	01.97–	VQ30DE	6		ZSE 078 <sup>202</sup>	
<b>M30 Coupe</b>								
3.0	3.0	121	01.89–12.93	VG30E	6	ZM 048	ZS 277	
<b>M35</b>								
3.5 Luxury	3.5	206	01.05–	VQ35DE	6		ZSE 132	
<b>M45</b>								
4.5 Luxury	4.5	250	01.05–	VK45DE	8		ZSE 132	
<b>Q45</b>								
4.1	4.1	205	01.93–	VH41DE	8		ZSE 074	
<b>QX4</b>								
3.3	3.3	125	01.97–	VG33E	6		ZSE 076	

## ISUZU

## ASCENDER

4.2	4.2	217	01.06–	LL8	6		ZSE 133	
<b>TROOPER</b>								
3.2	3.2	130	08.91–07.98	6VD1	6		ZS 355	

## JAGUAR

## S-TYPE

3.0 V6	3.0	175	01.99–10.07	AJ-V6	6		ZS 367
4.0 V8	4.0	203	01.99–04.02	AJ-V8	8		ZS 368

## XJ (XJ 40, 81)

6 3.2 24V	3.2	146	09.90–09.94	9BPMNA	6		ZS 126
6 3.6	3.6	136	10.86–08.89		6		ZS 126
6 3.6	3.6	145	10.86–08.89	9DPANA	6		ZS 126
6 3.6	3.6	156	10.86–08.89	9DPANA/AJ 6 (3.6, 156KW)	6		ZS 126
6 4.0	4.0	163	09.89–09.94	9EPCNA	6		ZS 126

## XJ (X300)

6 3.2	3.2	155	11.94–07.97	9JPGRB	6		ZS 126
R Super Charged 4.0	4.0	235	11.94–07.97	9KPDRB	6		ZS 126

## XJ (NAW, NBW)

8 3.2	3.2	174	07.97–05.03		8		ZS 368
8 4.0	4.0	209	07.97–05.03	BC	8		ZS 368

## XJ Coupe

3.6	3.6	136	01.88–08.89		6		ZS 126
3.6	3.6	146	01.88–05.91	9DPANA/9DPALA Fgst.Nr.139052→ Fgst.Nr.→226645	6		ZS 126
3.6	3.6	156	08.87–08.89	AJ 6 (3.6, 156KW)	6		ZS 126
3.6	3.6	162	10.86–12.88	AJ 6 (3.6, 162KW) Fgst.Nr.139052→ Fgst.Nr.→226645	6		ZS 126
4.0	4.0	163	05.91–09.94	9EPCNA Fgst.Nr.179737→ Fgst.Nr.→226645	6		ZS 126
4.0	4.0	171	10.94–03.96	9LPFRB Fgst.Nr.179737→ Fgst.Nr.→226645	6		ZS 126

## XJSC Convertible

3.6	3.6	136	01.88–05.91	Fgst.Nr.139052→ Fgst.Nr.→226645	6		ZS 126
3.6	3.6	156	01.88–05.91	AJ 6 (3.6, 156KW) Fgst.Nr.139052→ Fgst.Nr.→226645	6		ZS 126
3.6	3.6	162	10.86–12.88	AJ 6 (3.6, 162KW) Fgst.Nr.139052→ Fgst.Nr.→226645 Fgst.Nr.→226645	6		ZS 126
4.0	4.0	163	05.91–09.94	9EPCNA Fgst.Nr.179737→ Fgst.Nr.→226645	6		ZS 126



kW



**JAGUAR**

**XJSC Convertible**

4.0	4.0	171	10.94–03.96	9LPFRB Fgst.Nr.179737→ Fgst.Nr.→226645	6		<b>ZS 126</b>
-----	-----	-----	-------------	--	---	--	---------------

**JEEP**

**CHEROKEE**

2.5	2.5	89	10.90–09.96	EPE	4		<b>ZS 394</b>
2.5	2.5	89	10.90–09.96	EPE	4		<b>ZS 396</b>
2.5	2.5	90	10.86–09.90	EPE	4		<b>ZS 394</b>
2.5	2.5	90	10.86–09.90	EPE	4		<b>ZS 396</b>
2.5 4x4	2.5	90	10.86–09.90	EPE	4		<b>ZS 394</b>
2.5 4x4	2.5	90	10.86–09.90	EPE	4		<b>ZS 396</b>
2.5 i	2.5	87	11.96–09.01	EPE	4		<b>ZS 394</b>
2.5 i	2.5	87	11.96–09.01	EPE	4		<b>ZS 396</b>
2.5 i 4x4	2.5	90	12.91–09.01	EPE	4		<b>ZS 394</b>
2.5 SE	2.5	87	10.96–09.99	EPE	4		<b>ZS 394</b>
2.5 SE	2.5	87	10.96–09.99	EPE	4		<b>ZS 396</b>
4.0 i	4.0	131	01.95–09.01	ERH	6		<b>ZS 394</b>
4.0 i	4.0	135	12.91–09.01	MX	6		<b>ZS 394</b>
4.0 i	4.0	136	01.88–09.01	ERH	6		<b>ZS 394</b>
4.0 i	4.0	136	01.91–12.95	ERH	6		<b>ZS 393</b>

**COMANCHE**

2.5	2.5	90	10.86–09.90	EPE	4		<b>ZS 394</b>
4.0	4.0	130	01.91–12.92	ERH	6		<b>ZS 393</b>

**GRAND CHEROKEE I**

4.0 i	4.0	130	10.95–04.99	S01	6		<b>ZS 396</b>
4.0 i	4.0	132	09.91–04.99	ERH	6		<b>ZS 394</b>
4.0 i	4.0	132	09.91–04.99	ERH	6		<b>ZS 396</b>
4.0 i	4.0	135	09.91–04.99	MX	6		<b>ZS 394</b>
4.0 i	4.0	135	09.91–04.99	MX	6		<b>ZS 396</b>
4.0 Laredo	4.0	131	10.96–09.98	ERH	6		<b>ZS 394</b>
4.0 Laredo	4.0	131	10.96–09.98	ERH	6		<b>ZS 396</b>
5.2	5.2	156	10.95–04.99	Y01	8		<b>ZS 396</b>
5.2	5.2	164	10.96–09.98	ELF	8		<b>ZS 394</b>
5.2	5.2	164	10.96–09.98	ELF	8		<b>ZS 396</b>
5.2 4WD	5.2	164	10.96–09.98	ELF	8		<b>ZS 394</b>
5.2 4WD	5.2	164	10.96–09.98	ELF	8		<b>ZS 396</b>
5.2 i	5.2	155	01.92–04.99	ELF	8		<b>ZS 394</b>
5.2 Limited 4x4	5.2	136	10.96–09.98	ELF	8		<b>ZS 394</b>
5.2 Limited 4x4	5.2	136	10.96–09.98	ELF	8		<b>ZS 396</b>
5.9 i	5.9	177	08.97–04.99		8		<b>ZS 396</b>

**GRAND CHEROKEE II**

4.0 4x4	4.0	140	04.99–09.05		6		<b>ZS 396</b>
---------	-----	-----	-------------	--	---	--	---------------

**WRANGLER I**

2.5	2.5	76	01.88–12.91	4L <H>	4		<b>ZS 251</b>
2.5	2.5	89	12.91–08.96	EPE	4		<b>ZS 394</b>
2.5	2.5	89	12.91–08.96	EPE	4		<b>ZS 396</b>
4.0	4.0	131	12.91–08.96	ERH	6		<b>ZS 394</b>
4.0	4.0	131	12.91–08.96	ERH	6		<b>ZS 396</b>

**WRANGLER II**

2.4	2.4	105	11.02–04.07	ED1	4		<b>ZS 380</b>
2.5	2.5	87	08.96–04.07	P00	4		<b>ZS 396</b>
4.0	4.0	124	06.98–04.07		6		<b>ZS 396</b>
4.0	4.0	130	08.96–04.07	S01	6		<b>ZS 396</b>
4.0 Rubicon	4.0	128	08.03–04.07		6		<b>ZS 396</b>



kW

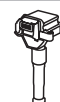

<b>KIA</b>							
<b>AVELLA</b>							
1.3	1.3	55	11.95–12.01	B3	4		<b>ZS 511</b>
1.5	1.5	55	02.97–12.01		4		<b>ZS 511</b>
<b>CARENS I</b>							
1.8 i	1.8	81	11.00–07.02	T8	4		<b>ZS 433</b>
<b>CARENS II</b>							
1.6	1.6	77	07.02–	GA6D	4		<b>ZS 433</b>
1.8	1.8	93	07.02–		4		<b>ZS 433</b>
<b>CLARUS</b>							
1.8 i 16V	1.8	85	07.96–	T8	4		<b>ZS 433</b>
<b>JOICE</b>							
2.0	2.0	102	02.00–	G4CP	4		<b>ZS 521</b>
<b>MAGENTIS</b>							
2.0	2.0	100	05.01–	G4JP	4		<b>ZSE 502</b>
2.5 V6	2.5	124	05.01–	G6BV	6		<b>ZS 269</b>
<b>OPIRUS</b>							
3.5	3.5	149	09.03–	G6CU	6		<b>ZSE 087</b>
<b>PRIDE</b>							
1.1 i	1.1	38	01.91–	B1	4		<b>ZS 511</b>
1.3 16V	1.3	44	01.90–	B3	4		<b>ZS 511</b>
1.3 16V	1.3	47	10.96–	B3	4		<b>ZS 511</b>
1.3 16V	1.3	53	01.90–	B3	4		<b>ZS 511</b>
1.3 i	1.3	51	01.90–		4		<b>ZS 511</b>
<b>RETONA</b>							
2.0 16V	2.0	94	05.00–	FE (16 V)	4		<b>ZS 434</b>
<b>SEPHIA</b>							
1.5 i	1.5	59	02.96–10.97	B5	4		<b>ZS 436</b>
1.8 i 16V	1.8	82	01.95–10.97	OK24N/OK26Y	4		<b>ZS 433</b>
<b>SHUMA</b>							
1.5 i 16V	1.5	65	10.97–03.01		4		<b>ZS 436</b>
1.8 i 16V	1.8	81	10.97–03.01	T8	4		<b>ZS 433</b>
<b>SHUMA II</b>							
1.8	1.8	84	04.03–08.04	T8	4		<b>ZS 433</b>
<b>SORENTO I</b>							
2.4	2.4	102	08.02–	G4JS	4		<b>ZSE 502</b>
3.5 V6	3.5	143	08.02–	G6CU	6		<b>ZSE 086</b>
3.5 V6	3.5	143	08.02–	G6CU	6		<b>ZSE 087</b>
<b>SPORTAGE</b>							
2.0	2.0	87	10.00–08.03		4		<b>ZS 434</b>
2.0 4WD	2.0	87	10.00–08.03		4		<b>ZS 434</b>
2.0 i 16V	2.0	94	10.99–08.03	FE (16 V)	4		<b>ZS 434</b>
2.0 i 16V 4WD	2.0	94	04.94–11.98	FE (16 V)	4		<b>ZS 234</b>
2.0 i 16V 4WD	2.0	94	12.98–08.03	FE (16 V)	4		<b>ZS 434</b>
2.0 i 4WD	2.0	70	04.94–08.99	FE	4		<b>ZS 234</b>
<b>LADA</b>							
<b>110</b>							
1.5	1.5	54	01.95–		4		<b>ZS 120</b>
1.5	1.5	57	01.95–12.00	VAZ-2111	4		<b>ZS 120</b>
1.5 16V	1.5	70	01.95–	VAZ-2112	4		<b>ZS 120</b>
1.6	1.6	60	01.05–	VAZ-21114	4		<b>ZS 395</b>
<b>111</b>							
1.5	1.5	56	10.00–	VAZ-2111	4		<b>ZS 120</b>
1.5	1.5	57	01.96–	VAZ-2111	4		<b>ZS 120</b>
1.5 16V	1.5	70	01.95–	VAZ-2112	4		<b>ZS 120</b>
1.6	1.6	66	03.06–	VAZ-21124	4		<b>ZS 395</b>
<b>112</b>							
1.5	1.5	54	01.95–		4		<b>ZS 120</b>
1.5	1.5	57	01.95–	VAZ-2111	4		<b>ZS 120</b>
1.5 16V	1.5	70	01.95–	VAZ-2112	4		<b>ZS 120</b>





kW

**LADA****1200-1500 Kombi**

1200	1.2	44	09.73-08.84	BA3 2101	4	<b>ZS 106</b>
1200	1.2	44	09.73-08.84	BA3 2101	4	<b>ZS 115</b>
1500	1.5	54	09.73-06.85	BA3 2103	4	<b>ZS 106</b>
1500	1.5	54	09.73-06.85	BA3 2103	4	<b>ZS 115</b>

**1200-1600**

1200 L/S	1.2	44	01.70-06.86	BA3 2101	4	<b>ZS 106</b>
1200 L/S	1.2	44	01.70-06.86	BA3 2101	4	<b>ZS 115</b>
1300	1.3	48	05.78-08.84	BA3 21011	4	<b>ZS 106</b>
1300	1.3	51	08.74-08.84	BA3 2105	4	<b>ZS 106</b>
1300	1.3	51	08.74-08.84	BA3 2105	4	<b>ZS 115</b>
1500	1.5	55	09.72-08.84	BA3 2103	4	<b>ZS 106</b>
1500	1.5	55	09.72-08.84	BA3 2103	4	<b>ZS 115</b>
1600	1.6	58	09.72-08.84	BA3 2106	4	<b>ZS 106</b>
1600 N/L	1.6	57	03.79-10.86	BA3 2106	4	<b>ZS 106</b>

**KALINA**

1.6	1.6	60	06.07-	VAZ-21114	4	<b>ZS 395</b>
1.6 16V	1.6	66	11.04-		4	<b>ZS 395</b>
1.6	1.6	60	10.04-	VAZ-21124/VAZ-21114	4	<b>ZS 395</b>

**NIVA**

1600	1.6	54	01.87-03.95	BA3 2121	4	<b>ZS 106</b>
1600	1.6	54	01.87-03.95	BA3 2121	4	<b>ZS 115</b>
1600	1.6	56	04.80-12.87	BA3 2121	4	<b>ZS 106</b>
1600	1.6	56	04.80-12.87	BA3 2121	4	<b>ZS 115</b>
1600	1.6	56	12.76-05.87	BA3 2121	4	<b>ZS 106</b>
1600	1.6	56	12.76-05.87	BA3 2121	4	<b>ZS 115</b>
1700 i	1.7	59	06.96-	BA3 21214	4	<b>ZS 395</b>
1700 i 1.7 4x4	1.7	61	09.10-		4	<b>ZS 395</b>
1700 i 4x4	1.7	60	10.00-		4	<b>ZS 120</b>
1700 i 4x4	1.7	60	10.00-		4	<b>ZS 395</b>

**NIVA II**

1.7	1.7	59	09.02-		4	<b>ZS 395</b>
1.7	1.7	61	06.07-		4	<b>ZS 395</b>
1.7 LPG	1.7	57	09.02-		4	<b>ZS 395</b>

**NOVA**

1200 Junior/L	1.2	44	09.81-	BA3 2101	4	<b>ZS 106</b>
1200 Junior/L	1.2	44	09.81-	BA3 2101	4	<b>ZS 115</b>
1300 Spezial/L	1.3	48	05.81-	BA3 2105	4	<b>ZS 106</b>
1300 Spezial/L	1.3	48	05.81-	BA3 2105	4	<b>ZS 115</b>
1500	1.5	49	05.93-04.04	BA3 2103 (KAT)	4	<b>ZS 106</b>
1500	1.5	49	05.93-04.04	BA3 2103 (KAT)	4	<b>ZS 115</b>
1500 Special	1.5	55	03.85-	BA3 2103	4	<b>ZS 106</b>
1500 Special	1.5	55	03.85-	BA3 2103	4	<b>ZS 115</b>
1700 i Classic	1.7	62	06.96-		4	<b>ZS 234</b>

**PRIORA**

1.6	1.6	60	10.09-		4	<b>ZS 395</b>
-----	-----	----	--------	--	---	---------------

**SAMARA**

1100	1.1	39	02.88-12.94	BA3 21081	4	<b>ZM 010</b>	<b>ZS 120</b>
1100	1.1	39	02.88-12.94	BA3 21081	4	<b>ZM 039</b>	<b>ZS 120</b>
1100	1.1	43	02.96-	BA3 21081 (KAT)	4	<b>ZM 010</b>	<b>ZS 120</b>
1100	1.1	43	02.96-	BA3 21081 (KAT)	4	<b>ZM 039</b>	<b>ZS 120</b>
1300	1.3	45	09.91-	BA3 2108 (KAT)	4	<b>ZM 010</b>	<b>ZS 106</b>
1300	1.3	45	09.91-	BA3 2108 (KAT)	4	<b>ZM 039</b>	<b>ZS 115</b>
1300	1.3	45	09.91-	BA3 2108 (KAT)	4		<b>ZS 120</b>
1300	1.3	46	01.88-	BA3 2108	4	<b>ZM 010</b>	<b>ZS 120</b>
1300	1.3	46	01.88-	BA3 2108	4	<b>ZM 039</b>	<b>ZS 120</b>
1300	1.3	48	01.86-12.94	BA3 2108	4	<b>ZM 010</b>	<b>ZS 120</b>
1300	1.3	48	01.86-12.94	BA3 2108	4	<b>ZM 039</b>	<b>ZS 120</b>
1300	1.3	50	02.96-	BA3 21115	4		<b>ZS 106</b>
1300	1.3	50	02.96-	BA3 21115	4		<b>ZS 115</b>
1300	1.3	50	02.96-	BA3 21115	4		<b>ZS 120</b>
1500	1.5	50	09.91-	BA3 21083 (KAT)	4	<b>ZM 039</b>	<b>ZS 106</b>



kW



<b>LADA</b>								
<b>SAMARA</b>								
1500	1.5	50	09.91–	BA3 21083 (KAT)	4	<b>ZM 039</b>	<b>ZS 115</b>	
1500	1.5	50	09.91–	BA3 21083 (KAT)	4	<b>ZM 039</b>	<b>ZS 120</b>	
1500	1.5	52	02.95–	BA3 2111	4	<b>ZM 039</b>	<b>ZS 120</b>	
1500	1.5	53	01.88–	BA3 21083	4	<b>ZM 010</b>		
1500	1.5	53	01.88–	BA3 21083	4	<b>ZM 039</b>		
<b>SAMARA FORMA</b>								
1100	1.1	39	07.91–12.00	BA3 21081 (KAT)	4	<b>ZM 039</b>	<b>ZS 115</b>	
1300	1.3	45	07.91–	BA3 2108	4	<b>ZM 039</b>		
1300	1.3	46	05.90–	BA3 2108	4	<b>ZM 039</b>		
1300	1.3	48	05.89–07.97	BA3 2108	4	<b>ZM 039</b>	<b>ZS 106</b>	
1300	1.3	48	05.89–07.97	BA3 2108	4	<b>ZM 039</b>	<b>ZS 115</b>	
1300	1.3	48	05.89–07.97	BA3 2108	4	<b>ZM 039</b>	<b>ZS 120</b>	
1500	1.5	50	07.91–	BA3 21083 (KAT)	4	<b>ZM 039</b>		
1500	1.5	52	11.94–12.00	BA3 2111	4	<b>ZM 039</b>	<b>ZS 120</b>	
1500	1.5	53	09.91–	BA3 21083	4	<b>ZM 039</b>	<b>ZS 106</b>	
1500	1.5	53	09.91–	BA3 21083	4	<b>ZM 039</b>	<b>ZS 115</b>	
1500	1.5	53	09.91–	BA3 21083	4	<b>ZM 039</b>	<b>ZS 120</b>	
<b>TOSCANA</b>								
1500	1.5	55	09.83–02.93	BA3 2103	4		<b>ZS 106</b>	
1500	1.5	55	09.83–02.93	BA3 2103	4		<b>ZS 115</b>	
<b>LANCIA</b>								
<b>A 112</b>								
0.9 Junior	0.9	29	03.81–06.86	A112 A5.000/A112 A.000/A112 B2.000	4		<b>ZS 106</b>	
1.0 LX	1.0	35	03.84–12.86	A112 B1.000	4	<b>ZM 005</b>	<b>ZS 106</b>	
<b>DEDRA</b>								
1.6 i.e.	1.6	55	04.93–10.94	835 C1.000	4		<b>ZS 234</b>	
1.8 i.e.	1.8	74	07.94–07.99	836 A5.000	4		<b>ZS 283</b>	
2.0 HF Integrale	2.0	124	11.90–07.94	835 A7.046	4		<b>ZS 106</b>	
2.0 HF Integrale	2.0	124	11.90–07.94	835 A7.046	4		<b>ZS 115</b>	
<b>DELTA I</b>								
1.3	1.3	55	09.79–08.92	831 A2.000/831 B.000	4	<b>ZM 009</b>		
1.3	1.3	55	01.86–12.86	831 A2.000/831 B.000 Mot.Nr.→6651557	4		<b>ZS 248</b>	
1.5	1.5	63	09.79–04.86	831 A1.000/831 B1.000	4	<b>ZM 005</b>		
1.5	1.5	63	09.79–12.92	831 A1.000/831 B1.000	4		<b>ZS 106</b>	
1.5	1.5	63	09.79–12.92	831 A1.000/831 B1.000	4		<b>ZS 115</b>	
1.6 GT	1.6	77	11.82–04.86	831 A4.000	4		<b>ZS 106</b>	
1.6 GT	1.6	77	11.82–04.86	831 A4.000	4		<b>ZS 115</b>	
1.6 GT i.e.	1.6	66	05.87–08.92	149 C2.000	4		<b>ZS 106</b>	
1.6 GT i.e.	1.6	66	05.87–08.92	149 C2.000	4		<b>ZS 115</b>	
1.6 HF Turbo	1.6	96	05.86–12.86	831 A7.000	4	<b>ZM 061</b>		
1.6 HF Turbo	1.6	97	04.87–03.89	831 B7.046	4		<b>ZS 106</b>	
1.6 HF Turbo	1.6	97	04.87–03.89	831 B7.046	4		<b>ZS 115</b>	
1.6 HF Turbo	1.6	103	08.86–08.88	831 B3.000	4	<b>ZM 061</b>		
2.0 16V HF Evo Integrale	2.0	155	06.93–01.94	831 E5.046/831 E5.000	4		<b>ZS 283</b>	
2.0 HF Integrale	2.0	122	11.86–08.88	831 B5.000	4	<b>ZM 061</b>		
<b>DELTA II</b>								
1.4 i.e.	1.4	51	10.94–08.99	836 A4.000	4		<b>ZS 234</b>	
1.6 i.e.	1.6	55	06.93–08.99	835 C1.000	4		<b>ZS 234</b>	
1.6 i.e.	1.6	66	03.96–08.99	182 A6.000	4		<b>ZS 029</b>	
1.6 i.e. 16V	1.6	76	01.96–08.99	182 A4.000	4		<b>ZS 029</b>	
1.8 i.e.	1.8	76	06.93–08.99	835 C2.000	4		<b>ZS 283</b>	
2.0 16V Turbo	2.0	137	06.93–08.99	836 A2.000	4		<b>ZS 283</b>	
2.0 16V Turbo	2.0	142	07.96–08.99	175 A4.000	4		<b>ZS 283</b>	
<b>DELTA III</b>								
1.4	1.4	88	09.08–	198 A4.000	4		<b>ZS 095</b>	
1.4	1.4	110	09.08–	198 A1.000	4		<b>ZS 095</b>	
1.4 Bifuel	1.4	88	07.11–	198 A4.000	4		<b>ZS 095</b>	
<b>KAPPA</b>								
2.0 16V Turbo	2.0	151	02.95–10.01	838 A4.000	4	<b>ZM 026</b>	<b>ZS 234</b>	



kW

**LANCIA**

<b>KAPPA</b>							
2.0 20V	2.0	107	10.94-10.01	838 A1.000	5		<b>ZS 310</b>
2.0 20V	2.0	114	07.96-10.01	838 A6.000	5		<b>ZS 310</b>
2.0 20V Turbo	2.0	162	06.98-10.01	175 A3.000	5		<b>ZS 310</b>
2.4 20V	2.4	129	08.94-10.01	838 A2.000/838 A2.027	5		<b>ZS 310</b>
3.0 24V	3.0	150	08.94-10.01	838 B.000	6		<b>ZS 428</b>
<b>KAPPA SW</b>							
2.0 16V Turbo	2.0	151	07.96-10.01	838 A4.000	4		<b>ZS 234</b>
2.0 20V	2.0	114	07.96-10.01	838 A6.000	5		<b>ZS 310</b>
2.0 20V	2.0	114	07.96-10.01	838 A6.000	5		<b>ZS 311</b>
2.0 20V Turbo	2.0	162	06.98-10.01	175 A3.000	5		<b>ZS 310</b>
2.4 20V	2.4	129	07.96-10.01	838 A2.000	5		<b>ZS 310</b>
2.4 20V	2.4	129	07.96-10.01	838 A2.000	5		<b>ZS 311</b>
3.0 24V	3.0	150	07.96-10.01	838 B.000	6		<b>ZS 428</b>
<b>LYBRA</b>							
1.6 16V	1.6	76	07.99-10.05	182 A4.000	4		<b>ZS 029</b>
2.0 20V	2.0	110	09.00-10.05	185 A8.000	5		<b>ZS 311</b>
2.0 20V	2.0	113	07.99-09.00	182 B7.000	5		<b>ZS 311</b>
<b>MUSA</b>							
1.4	1.4	57	09.05-	350 A1.000	4		<b>ZS 079</b>
1.4	1.4	66	10.07-	192 B2.000	4		<b>ZS 322</b>
1.4	1.4	70	10.04-	843 A 1.000	4		<b>ZS 322</b>
1.4 LPG	1.4	57	11.10-	350 A1.000	4		<b>ZS 079</b>
<b>PHEDRA</b>							
3.0 V6	2.9	150	09.02-11.10	ES9 J4S	6		<b>ZS 347</b>
<b>PRISMA</b>							
1.5	1.5	63	01.83-04.86	831 A1.000	4	<b>ZM 005</b>	<b>ZS 106</b>
1.5	1.5	63	01.83-04.86	831 A1.000	4	<b>ZM 005</b>	<b>ZS 115</b>
1.6	1.6	77	01.83-04.86	831 A4.000	4		<b>ZS 106</b>
1.6	1.6	77	01.83-04.86	831 A4.000	4		<b>ZS 115</b>
1.6 i.e.	1.6	80	05.86-12.89	831 B7.000	4	<b>ZM 061</b>	
1.6 i.e. Super	1.6	66	05.87-12.89	149 C2.000	4	<b>ZM 061</b>	<b>ZS 106</b>
1.6 i.e. Super	1.6	66	05.87-12.89	149 C2.000	4	<b>ZM 061</b>	<b>ZS 115</b>
2.0 i.e. 4WD	2.0	85	04.86-12.89	831 B4.000	4		<b>ZS 106</b>
2.0 i.e. 4WD	2.0	85	04.86-12.89	831 B4.000	4		<b>ZS 115</b>
<b>THEMA</b>							
2000 16V	2.0	112	08.92-12.93	834 F1.000	4		<b>ZS 234</b>
2000 16V Turbo	2.0	133	12.88-06.90	834 C1.000	4		<b>ZS 283</b>
2000 16V Turbo	2.0	148	10.92-07.94	834 F2.000	4	<b>ZM 026</b>	<b>ZS 234</b>
2000 i.e.	2.0	83	03.86-09.88	834 B.048	4		<b>ZS 106</b>
2000 i.e.	2.0	83	03.86-09.88	834 B.048	4		<b>ZS 115</b>
2000 i.e.	2.0	85	09.87-05.92	834 B.146	4	<b>ZM 061</b>	<b>ZS 106</b>
2000 i.e.	2.0	85	09.87-05.92	834 B.146	4	<b>ZM 061</b>	<b>ZS 115</b>
2000 i.e. 16V	2.0	104	02.89-05.92	834 B2.246	4		<b>ZS 283</b>
2000 i.e. 16V Turbo	2.0	130	04.89-05.92	834 C1.246	4	<b>ZM 061</b>	<b>ZS 248</b>
2000 i.e. Turbo	2.0	110	07.86-05.90	834 C.146	4	<b>ZM 061</b>	<b>ZS 106</b>
2000 i.e. Turbo	2.0	110	07.86-05.90	834 C.146	4	<b>ZM 061</b>	<b>ZS 115</b>
2000 i.e. Turbo	2.0	122	07.86-12.87	834 C.000	4	<b>ZM 061</b>	
2850 V6 i.e.	2.8	108	06.88-05.92	834 E.146	6		<b>ZS 119</b>
2850 V6 i.e.	2.8	108	06.88-09.91	834 E.146	6	<b>ZM 040</b>	
3000 V6	3.0	126	08.92-07.94	834 F.000	6		<b>ZS 230</b>
<b>THEMA SW</b>							
2000 16V	2.0	112	05.92-07.94	834 F1.000	4		<b>ZS 234</b>
2000 i.e. 16V	2.0	104	02.89-05.92	834 B2.246	4	<b>ZM 061</b>	<b>ZS 106</b>
2000 i.e. 16V	2.0	104	02.89-05.92	834 B2.246	4	<b>ZM 061</b>	<b>ZS 115</b>
2000 i.e. 16V Turbo	2.0	130	04.89-03.93	834 C1.246	4		<b>ZS 248</b>
2000 i.e. 16V Turbo	2.0	133	12.88-06.90	834 C1.000	4		<b>ZS 283</b>
2000 Turbo 16V	2.0	148	11.92-07.94	834 F2.000	4		<b>ZS 234</b>
3000 V6	3.0	126	09.92-07.94	834 F.000	6		<b>ZS 230</b>
<b>THEISIS</b>							
2.0 Turbo	2.0	136	07.02-07.09	841 E.000	5		<b>ZS 311</b>
2.4	2.4	125	07.02-07.09	841 D.000	5		<b>ZS 311</b>



kW

**LANCIA**

<b>LANCIA</b>								
<b>THESIS</b>								
3.0 V6	3.0	158	07.02-07.09	841 A.000	6		<b>ZS 428</b>	
3.2 V6	3.2	169	05.03-07.09	841 L.000	6		<b>ZS 428</b>	
<b>Y</b>								
1.1	1.1	40	11.95-09.03	176 B2.000	4		<b>ZS 283</b>	
1.2	1.2	44	03.96-09.03	840 A3.000/188 A4.000	4		<b>ZS 283</b>	
1.2 16V	1.2	59	10.00-09.03	188 A5.000	4		<b>ZS 234</b>	
1.2 16V	1.2	63	04.97-09.03	176 B9.000	4		<b>ZS 283</b>	
1.4 12V	1.4	55	03.96-09.03	840 A4.000	4		<b>ZS 234</b>	
1.4 12V	1.4	59	10.96-09.03	840 A2.000	4		<b>ZS 234</b>	
<b>Y10</b>								
1.0 Fire	1.0	32	06.85-06.91	156 A 2.100	4	<b>ZM 009</b>		
1.0 Fire	1.0	32	01.89-06.91	156 A 2.100	4		<b>ZS 244</b>	
1.0 Fire	1.0	32	06.85-12.89	156 A 2.100	4	<b>ZM 017</b>		
1.0 Fire	1.0	33	03.85-06.89	156 A 2.000	4	<b>ZM 009</b>	<b>ZS 244</b>	
1.0 Fire	1.0	33	03.85-06.89	156 A 2.000	4	<b>ZM 017</b>	<b>ZS 244</b>	
1.0 Fire	1.0	33	10.87-02.92	156 A2.246	4	<b>ZM 009</b>		
1.0 Fire	1.0	33	01.89-02.92	156 A2.246	4		<b>ZS 244</b>	
1.0 Fire	1.0	33	10.87-12.89	156 A2.246	4	<b>ZM 017</b>		
1.0 Fire	1.0	37	03.85-02.90	156 A 2.000	4	<b>ZM 009</b>		
1.0 Fire	1.0	37	03.85-08.89	156 A 2.000	4	<b>ZM 017</b>		
1.0 Fire	1.0	41	03.85-07.89	156 A.000	4	<b>ZM 009</b>		
1.0 Fire	1.0	41	03.85-07.89	156 A.000	4	<b>ZM 017</b>		
1.0 Fire 4WD	1.0	32	12.86-02.89	156 A 2.100	4	<b>ZM 009</b>		
1.0 Fire 4WD	1.0	32	12.86-02.89	156 A 2.100	4	<b>ZM 017</b>		
1.0 Fire 4WD	1.0	33	12.87-02.92	156 A2.246	4	<b>ZM 009</b>		
1.0 Fire 4WD	1.0	33	12.87-08.89	156 A2.246	4	<b>ZM 017</b>		
1.0 Fire 4WD	1.0	37	12.87-02.90	156 A 2.000	4	<b>ZM 009</b>		
1.0 Fire 4WD	1.0	37	12.87-08.89	156 A 2.000	4	<b>ZM 017</b>		
1.0 Turbo	1.0	62	03.85-02.89	156 A 1.000	4	<b>ZM 009</b>		
1.0 Turbo	1.0	62	03.85-02.89	156 A 1.000	4	<b>ZM 017</b>		
1.1 Avenue	1.1	40	01.95-12.95	176 B2.000	4	<b>ZM 009</b>	<b>ZS 234</b>	
1.1 Avenue 4WD	1.1	40	01.95-12.95	176 B2.000	4	<b>ZM 009</b>	<b>ZS 234</b>	
1.1 i.e. Fire	1.1	37	01.92-09.95	156 C.046	4	<b>ZM 009</b>	<b>ZS 234</b>	
1.1 i.e. Fire	1.1	37	07.89-12.92	156 C.046	4	<b>ZM 009</b>	<b>ZS 244</b>	
1.1 i.e. Fire 4WD	1.1	37	09.92-12.95	156 C.046	4	<b>ZM 009</b>	<b>ZS 234</b>	
1.3 i.e. Fire	1.3	53	02.89-12.95	156 B.000/146 A 5.046	4	<b>ZM 009</b>	<b>ZS 248</b>	
<b>YPSILON</b>								
0.9 Twinair	0.9	63	05.11-	312 A2.000	2		<b>ZS 090</b>	<b>GS 51</b>
1.2	1.2	44	10.03-12.11	188 A4.000	4		<b>ZS 283</b>	
1.2	1.2	51	08.10-12.11	169 A4.000 Euro 4 (D4)	4		<b>ZS 283</b>	
1.2	1.2	51	08.10-12.11	169 A4.000 Euro 5	4		<b>ZS 079</b>	
1.2	1.2	51	05.11-	169 A4.000 Euro 5	4		<b>ZS 079</b>	
1.2	1.2	51	05.11-	169 A4.000 Euro 4 (D4)	4		<b>ZS 283</b>	
1.2	1.2	59	10.03-12.11	188 A5.000	4		<b>ZS 322</b>	
1.2 Bifuel	1.2	49	05.11-	169 A4.000 Euro 5	4		<b>ZS 079</b>	
1.2 Bifuel	1.2	49	05.11-	169 A4.000 Euro 4 (D4)	4		<b>ZS 283</b>	
1.4	1.4	57	02.06-12.11	350 A1.000	4		<b>ZS 079</b>	
1.4 16V	1.4	70	10.03-12.11	843 A 1.000	4		<b>ZS 322</b>	
1.4 LPG	1.4	57	11.10-12.11	350 A1.000	4		<b>ZS 079</b>	
<b>ZETA</b>								
2.0 Turbo	2.0	108	05.95-09.02	RGX (XU10J2TE)	4	<b>ZM 026</b>	<b>ZS 341</b>	



kW



**LAND ROVER**

<b>88/109</b>								
2.3	2.3	51	09.63–12.86	11H		4		<b>ZS 109</b>
<b>90/110</b>								
2.5	2.5	62	09.85–07.90	17 H		4		<b>ZS 106</b>
<b>DISCOVERY II</b>								
4.0 V8	4.0	136	11.98–06.04	56 D		8		<b>ZS 234</b>
<b>FREELANDER</b>								
1.8 16V	1.8	86	11.00–10.06	18 K4F		4		<b>ZS 501</b>
1.8 16V	1.8	88	02.98–11.00	18 K4F		4		<b>ZS 501</b>
2.5 V6	2.5	130	11.00–03.03	25 K4F		6		<b>ZS 435<sup>202</sup></b>
2.5 V6	2.5	130	11.00–03.03	25 K4F		6		<b>ZS 437<sup>202</sup></b>
<b>RANGE ROVER I</b>								
3.5	3.5	107	01.87–09.90	31 D		8	<b>ZM 047</b>	
3.5 Vogue	3.5	93	01.87–09.90	11 D		8	<b>ZM 047</b>	
3.5 Vogue	3.5	120	01.87–09.90	25 D/24 D		8	<b>ZM 047</b>	
3.9 KAT	4.0	127	11.88–07.94	37 D/38 D		8		<b>ZS 117</b>
3.9 KAT	4.0	127	11.88–12.90	37 D/38 D		8	<b>ZM 047</b>	
3.9 Vogue SEI	4.0	134	11.88–07.94	36 D/35 D		8		<b>ZS 117</b>
3.9 Vogue SEI	4.0	134	11.88–12.90	36 D/35 D		8	<b>ZM 047</b>	

**LINCOLN**

<b>AVIATOR</b>								
4.6	4.6	222	04.02–01.05			8		<b>ZS 369</b>
<b>CONTINENTAL</b>								
4.6	4.6	202	06.98–01.02			8		<b>ZS 369</b>
<b>LS</b>								
3.0 V6 24V	3.0	140	05.98–			6		<b>ZS 367</b>
3.9 V8 32V	3.9	180	05.98–			8		<b>ZS 368</b>
<b>NAVIGATOR</b>								
5.4	5.4	224	01.99–12.02			8		<b>ZS 369</b>

**LOTUS**

<b>ELISE</b>								
111 S	1.8	107	03.99–11.00	18 K4K		4		<b>ZS 502</b>

**MAZDA**

<b>121 I</b>								
1.3	1.3	40	04.89–10.90	B3		4	<b>ZM 025</b>	
1.3	1.3	44	10.87–11.90	B3		4	<b>ZM 025</b>	
<b>121 II</b>								
1.3 16V	1.3	39	11.90–03.96	B3 (16V)		4	<b>ZM 025</b>	
1.3 16V	1.3	53	11.90–03.96	B3 (16V)		4	<b>ZM 025</b>	
<b>121 III</b>								
1.25	1.2	55	03.96–04.03	DHG/DHF		4		<b>ZS 239</b>
1.25	1.2	55	03.96–04.03	DHG/DHF		4		<b>ZS 350</b>
1.3	1.3	37	03.96–04.03	JJM/JJK		4		<b>ZS 350</b>
1.3	1.3	44	03.96–04.03	J4R/J4T		4		<b>ZS 350</b>
<b>2</b>								
1.25	1.2	55	04.03–02.05	FUJA		4		<b>ZS 350</b>
1.4	1.4	59	04.03–02.05	FXJA		4		<b>ZS 350</b>
1.6	1.6	74	04.03–02.05	FYJA		4		<b>ZS 350</b>
<b>3</b>								
1.4	1.4	59	02.04–02.05	FXJA		4		<b>ZS 350</b>
1.4	1.4	59	03.05–06.09	FXJA		4		<b>ZS 387</b>
2.0	2.0	110	10.03–02.06	LF17		4		<b>ZS 422</b>
<b>323 II</b>								
1.1	1.1	40	09.82–10.85	E1		4	<b>ZM 022</b>	
1.3	1.3	44	09.82–10.85	E3		4	<b>ZM 022</b>	
1.3	1.3	50	09.82–10.89	E3		4	<b>ZM 022</b>	
1.5	1.5	55	05.81–07.85	E5		4	<b>ZM 022</b>	
1.5	1.5	65	09.82–12.85	E5		4	<b>ZM 022</b>	



kW

**MAZDA**

<b>323 III</b>							
1.3	1.3	44	08.87-05.89	E3	4	ZM 024	
1.3	1.3	44	08.85-05.89	E3	4		ZS 274
1.3	1.3	44	08.85-07.87	E3	4	ZM 022	
1.5	1.5	55	08.85-08.87	E5	4	ZM 022	
1.6 GT	1.6	63	11.86-06.87	B6 (SOHC)	4	ZM 022	
1.6 GT	1.6	63	07.87-10.89	B6 (SOHC)	4	ZM 024	
1.6 GT	1.6	63	11.86-10.89	B6 (SOHC)	4		ZS 274
1.6 GT	1.6	77	01.86-08.87	B6 (SOHC)	4	ZM 022	
<b>323 C IV</b>							
1.3 16V	1.3	54	04.91-07.94	B3 (16V)	4	ZM 050	ZS 279
1.6	1.6	62	09.89-06.91	B6E	4	ZM 025	ZS 279
1.8 16V 4WD	1.8	76	11.91-12.93	BP	4	ZM 050	ZS 279
1.8 16V GT	1.8	94	01.90-03.93	BP (DOHC)	4	ZM 050	
1.8 16V Turbo 4WD	1.8	120	09.90-12.92	BP Turbo	4	ZM 050	
1.8 16V Turbo 4WD	1.8	136	01.93-07.94	BP Turbo	4	ZM 050	
<b>323 F IV</b>							
1.6	1.6	62	09.89-06.91	B6E	4	ZM 025	ZS 279
1.6 16V	1.6	65	03.91-10.94	B6	4	ZM 050	ZS 279
1.8 16V	1.8	76	08.89-07.94	BP Fgst.Nr.500001→	4	ZM 050	
1.8 16V GT	1.8	94	01.90-07.94	BP (DOHC)	4	ZM 050	
1.8 4WD	1.8	76	01.91-04.94	BPC	4	ZM 050	
<b>323 F V</b>							
1.5 16V	1.5	65	07.94-09.98	Z5-DE	4	ZM 024	
<b>323 F VI</b>							
1.5 16V	1.5	65	09.98-01.01		4	ZM 024	
1.9 16V	1.8	84	09.98-01.01	FP55	4		ZSE 083
2.0	2.0	96	01.01-05.04	FS7G/FS7E	4		ZSE 083
<b>6</b>							
2.3	2.3	122	06.02-02.05	L3C1	4		ZS 422
<b>626 II</b>							
1.6	1.6	59	11.82-06.87	F6	4	ZM 022	
2.0	2.0	68	11.86-09.87	FE	4	ZM 022	
2.0	2.0	74	03.83-09.87	FE	4	ZM 022	
2.0	2.0	88	01.86-09.87	FE	4	ZM 022	
<b>626 III</b>							
1.8	1.8	65	11.87-05.92	F8 (12V)	4	ZM 024	
2.0	2.0	66	09.87-10.90	FE	4	ZM 024	
2.0 12V	2.0	79	09.87-05.92	FE (12V)	4	ZM 024	ZS 274
2.0 16V	2.0	103	11.87-05.92	FE Kat. (16V)	4	ZM 024	ZS 274
2.0 16V	2.0	109	07.87-09.89	FE Kat. (16V)	4	ZM 024	
2.2 12V 4WD	2.2	85	01.90-05.92	F2	4		ZS 274
<b>626 III Station Wagon</b>							
1.8	1.8	65	01.88-03.92	F8 (12V)	4	ZM 024	
2.0	2.0	66	10.88-09.97	FE	4	ZM 024	
2.0 12V	2.0	81	09.87-01.90	FE (12V)	4	ZM 024	
2.0 16V	2.0	103	01.88-03.92	FE Kat. (16V)	4	ZM 024	
<b>626 IV</b>							
1.8 i	1.8	66	08.94-04.97		4	ZM 024	
1.8 i	1.8	77	01.92-04.97	FP	4	ZM 024	
<b>626 V (GF)</b>							
2.0	2.0	85	05.97-10.02	FS	4		ZS 237
<b>626 V</b>							
2.0	2.0	93	01.98-10.02	FS	4		ZS 281
2.0	2.0	100	04.98-10.02	FS2C	4		ZS 052 <sup>282</sup> GS 29
<b>626 V Station Wagon</b>							
2.0	2.0	85	02.98-10.02	FS	4		ZS 281
2.0	2.0	93	01.98-10.02	FS	4		ZS 281
<b>929 III</b>							
2.0	2.0	85	06.87-12.88	FEFA/FE	4	ZM 024	
3.0	3.0	125	01.88-12.89	JE3	6		ZS 274



kW



**MAZDA**

<b>929 III</b>								
3.0	3.0	140	01.90–06.91	JE	6	<b>ZM 024</b>		
3.0	3.0	140	06.87–06.91	JE	6		<b>ZS 274</b>	
3.0 i	3.0	123	01.90–06.91	JE3	6		<b>ZS 274</b>	
<b>MX-3</b>								
1.6 i	1.6	65	07.91–	B69	4		<b>ZS 279</b>	
<b>MX-5 II</b>								
1.8	1.8	103	01.98–07.02	BPD	4		<b>ZSE 084</b>	
1.8 16V	1.8	102	11.00–10.05	BPD	4		<b>ZSE 084</b>	
1.8 16V	1.8	107	11.00–10.05	BPD	4		<b>ZSE 084</b>	
<b>PREMACY</b>								
1.8	1.8	74	07.99–03.05	FP	4		<b>ZSE 083</b>	
1.9	1.8	84	07.99–03.05	FP	4		<b>ZSE 083</b>	
2.0	2.0	96	11.01–03.05	FS7G/FS7E	4		<b>ZSE 083</b>	
<b>TRIBUTE</b>								
2.0	2.0	91	03.00–12.05	YF	4		<b>ZS 350</b>	
3.0 V6 24V 4WD	3.0	145	03.00–05.08	AJ	6		<b>ZS 410</b>	
3.0 V6 AWD	3.0	149	04.04–05.08	AJ	6		<b>ZS 410</b>	

**MERCEDES-BENZ**

<b>A-KLASSE (W168)</b>								
A 140	1.4	60	07.97–08.04	M 166.940	4		<b>ZSE 146</b>	
A 140	1.6	60	01.01–08.04	M 166.960	4		<b>ZSE 146</b>	
A 160	1.6	75	07.97–08.04	M 166.960	4		<b>ZSE 146</b>	
A 190	1.9	92	03.99–08.04	M 166.990	4		<b>ZSE 146</b>	
A 210	2.1	103	03.02–08.04	M 166.995	4		<b>ZSE 146</b>	
<b>A-KLASSE (W169)</b>								
A 150	1.5	70	09.04–06.12	M 266.920	4		<b>ZS 297</b>	
A 160	1.5	70	04.09–06.12	M 266.920	4		<b>ZS 297</b>	
A 170	1.7	85	09.04–06.12	M 266.940	4		<b>ZS 297</b>	
A 200	2.0	100	09.04–06.12	M 266.960	4		<b>ZS 297</b>	
A 200 TURBO	2.0	142	09.05–06.12	M 266.980	4		<b>ZS 297</b>	
<b>B-KLASSE (W245)</b>								
B 150	1.5	70	03.05–11.11	M 266.920	4		<b>ZS 297</b>	
B 170	1.7	85	03.05–11.11	M 266.940	4		<b>ZS 297</b>	
B 180	1.7	85	04.09–11.11	M 266.940	4		<b>ZS 297</b>	
B 200	2.0	100	03.05–11.11	M 266.960	4		<b>ZS 297</b>	
B 200 TURBO	2.0	142	03.05–11.11	M 266.980	4		<b>ZS 297</b>	
<b>C-KLASSE (W202)</b>								
C 180	1.8	89	11.94–08.95	M 111.921	4		<b>ZS 313</b>	
C 180	1.8	89	09.95–05.00	M 111.921	4		<b>ZS 340</b>	<b>ZLE 234</b>
C 180	1.8	90	03.93–08.95	M 111.920	4		<b>ZS 313</b>	
C 180	1.8	90	09.95–05.00	M 111.921	4		<b>ZS 340</b>	<b>ZLE 234</b>
C 200	2.0	100	01.94–08.95	M 111.941	4		<b>ZS 313</b>	
C 200	2.0	100	09.95–05.00	M 111.945	4		<b>ZS 340</b>	<b>ZLE 234</b>
C 200 Kompressor	2.0	132	10.95–05.00	M 111.944	4		<b>ZS 340</b>	<b>ZLE 234</b>
C 200 Kompressor	2.0	141	11.96–05.00	M 111.944	4		<b>ZS 340</b>	<b>ZLE 234</b>
C 220	2.2	110	03.93–08.95	M 111.961	4		<b>ZS 313</b>	
C 220	2.2	110	09.95–05.00	M 111.961	4		<b>ZS 340</b>	<b>ZLE 234</b>
C 230	2.3	110	06.96–06.97	M 111.974	4		<b>ZS 340</b>	<b>ZLE 234</b>
C 230 Kompressor	2.3	142	10.95–05.00	M 111.975	4		<b>ZS 340</b>	<b>ZLE 234</b>
C 240	2.4	125	06.97–05.00	M 112.910	6		<b>ZS 297</b>	
C 280	2.8	142	05.93–05.00	M 104.941	6		<b>ZS 340</b>	<b>ZLE 234</b>
C 280	2.8	145	06.97–05.00	M 112.920	6		<b>ZS 297</b>	
C 36 AMG	3.6	206	05.94–05.00	M 104.941 (AMG 3.6)	6		<b>ZS 340</b>	<b>ZLE 234</b>
C 43 AMG	4.3	225	08.97–05.00	M 113.944	8		<b>ZS 297</b>	
<b>C-KLASSE Kombi (S202)</b>								
C 180 T	1.8	90	06.96–09.00	M 111.920	4		<b>ZS 313</b>	
C 180 T	1.8	90	06.96–09.00	M 111.921	4		<b>ZS 340</b>	<b>ZLE 234</b>
C 180 T	2.0	95	09.00–03.01	M 111.952	4		<b>ZS 041</b>	<b>GS 17</b>
C 200 T	2.0	100	06.96–03.01	M 111.941	4		<b>ZS 313</b>	
C 200 T	2.0	100	06.96–03.01	M 111.945	4		<b>ZS 340</b>	<b>ZLE 234</b>



kW

**MERCEDES-BENZ**
**C-KLASSE Kombi (S202)**

C 200 T Kompressor	2.0	120	09.00–03.01	M 111.956	4	<b>ZS 041</b>	<b>GS 17</b>
C 200 T Kompressor	2.0	141	11.96–03.01	M 111.944	4	<b>ZS 340</b>	<b>ZLE 234</b>
C 230 T	2.3	110	06.96–06.98	M 111.974	4	<b>ZS 340</b>	<b>ZLE 234</b>
C 230 T Kompressor	2.3	142	06.97–09.00	M 111.975	4	<b>ZS 340</b>	<b>ZLE 234</b>
C 240 T	2.4	125	06.97–09.00	M 112.910	6	<b>ZS 297</b>	
C 240 T	2.6	125	09.00–03.01	M 112.915	6	<b>ZS 297</b>	
C 280 T	2.8	145	06.97–03.01	M 112.920	6	<b>ZS 297</b>	
C 43 AMG	4.3	225	08.97–03.01	M 113.944	8	<b>ZS 297</b>	

**C-KLASSE (W203)**

C 180	2.0	95	10.00–05.02	M 111.951	4	<b>ZS 041</b>	<b>GS 17</b>
C 180 Kompressor	1.8	105	05.02–11.06	M 271.946 Mot.Nr.→3085 3899	4	<b>ZS 053</b>	<b>GS 21</b>
C 180 Kompressor	1.8	105	11.06–02.07	M 271.946 Mot.Nr.3085 3900→	4	<b>ZS 077</b>	<b>GS 21</b>
C 200 CGI Kompressor	1.8	125	07.03–11.06	M 271.942 Mot.Nr.→3085 3899	4	<b>ZS 053</b>	<b>GS 21</b>
C 200 CGI Kompressor	1.8	125	11.06–02.07	M 271.942 Mot.Nr.3085 3900→	4	<b>ZS 077</b>	<b>GS 21</b>
C 200 Kompressor	1.8	120	05.02–11.06	M 271.940 Mot.Nr.→3085 3899	4	<b>ZS 053</b>	<b>GS 21</b>
C 200 Kompressor	1.8	120	11.06–02.07	M 271.940 Mot.Nr.3085 3900→	4	<b>ZS 077</b>	<b>GS 21</b>
C 200 Kompressor	2.0	120	05.00–05.02	M 111.955	4	<b>ZS 041</b>	<b>GS 17</b>
C 230	2.5	150	01.05–02.07	M 272.920	6	<b>ZSE 140</b>	
C 230 Kompressor	1.8	141	02.04–11.06	M 271.948 Mot.Nr.→3085 3899	4	<b>ZS 053</b>	<b>GS 21</b>
C 230 Kompressor	1.8	141	11.06–02.07	M 271.948 Mot.Nr.3085 3900→	4	<b>ZS 077</b>	<b>GS 21</b>
C 240	2.6	125	05.00–02.07	M 112.912	6	<b>ZS 297</b>	
C 240 4-matic	2.6	125	07.02–02.07	M 112.916	6	<b>ZS 297</b>	
C 280	3.0	170	01.05–02.07	M 272.940	6	<b>ZSE 140</b>	
C 280 4-matic	3.0	170	01.05–02.07	M 272.941	6	<b>ZSE 140</b>	
C 32 AMG Kompressor	3.2	260	09.02–02.07	M 112.961	6	<b>ZS 297</b>	
C 320	3.2	160	05.00–02.07	M 112.946	6	<b>ZS 297</b>	
C 320 4-matic	3.2	160	07.02–02.07	M 112.953	6	<b>ZS 297</b>	
C 350	3.5	200	01.05–02.07	M 272.960	6	<b>ZSE 140</b>	
C 350 4-matic	3.5	200	01.05–02.07	M 272.970	6	<b>ZSE 140</b>	
C 55 AMG	5.4	270	02.04–02.07	M 113.988	8	<b>ZS 297</b>	

**C-KLASSE Kombi (S203)**

C 180	2.0	95	03.01–05.02	M 111.951	4	<b>ZS 041</b>	<b>GS 17</b>
C 180 Kompressor	1.8	105	05.02–11.06	M 271.946 Mot.Nr.→3085 3899	4	<b>ZS 053</b>	<b>GS 21</b>
C 180 Kompressor	1.8	105	11.06–08.07	M 271.946 Mot.Nr.3085 3900→	4	<b>ZS 077</b>	<b>GS 21</b>
C 200 CGI Kompressor	1.8	125	07.03–11.06	M 271.942 Mot.Nr.→3085 3899	4	<b>ZS 053</b>	<b>GS 21</b>
C 200 CGI Kompressor	1.8	125	11.06–08.07	M 271.942 Mot.Nr.3085 3900→	4	<b>ZS 077</b>	<b>GS 21</b>
C 200 Kompressor	1.8	120	05.02–11.06	M 271.940 Mot.Nr.→3085 3899	4	<b>ZS 053</b>	<b>GS 21</b>
C 200 Kompressor	1.8	120	11.06–08.07	M 271.940 Mot.Nr.3085 3900→	4	<b>ZS 077</b>	<b>GS 21</b>
C 200 Kompressor	2.0	120	03.01–05.02	M 111.955	4	<b>ZS 041</b>	<b>GS 17</b>
C 230	2.5	150	01.05–08.07	M 272.920	6	<b>ZSE 140</b>	
C 230 Kompressor	1.8	141	02.04–11.06	M 271.948 Mot.Nr.→3085 3899	4	<b>ZS 053</b>	<b>GS 21</b>
C 230 Kompressor	1.8	141	11.06–08.07	M 271.948 Mot.Nr.3085 3900→	4	<b>ZS 077</b>	<b>GS 21</b>
C 240	2.6	125	03.01–08.07	M 112.912	6	<b>ZS 297</b>	
C 240 4-matic	2.6	125	07.02–01.04	M 112.916	6	<b>ZS 297</b>	
C 280	3.0	170	01.05–08.07	M 272.940	6	<b>ZSE 140</b>	
C 280 4-matic	3.0	170	01.05–08.07	M 272.941	6	<b>ZSE 140</b>	
C 32 AMG Kompressor	3.2	260	03.01–01.04	M 112.961	6	<b>ZS 297</b>	
C 320	3.2	160	03.01–08.07	M 112.946	6	<b>ZS 297</b>	





kW



**MERCEDES-BENZ**

**C-KLASSE Kombi (S203)**

C 320 4-matic	3.2	160	07.02–08.07	M 112.953	6	ZS 297	
C 350	3.5	200	01.05–08.07	M 272.960	6	ZSE 140	
C 350 4-matic	3.5	200	01.05–08.07	M 272.970	6	ZSE 140	

**C-KLASSE Sportcoupe (CL203)**

C 160 Kompressor	1.8	90	05.02–11.06	M 271.921 Mot.Nr.→3085 3899	4	ZS 053	GS 21
C 160 Kompressor	1.8	90	11.06–05.08	M 271.921 Mot.Nr.3085 3900→	4	ZS 077	GS 21
C 180	2.0	95	03.01–05.02	M 111.951	4	ZS 041	GS 17
C 180 Kompressor	1.8	105	05.02–11.06	M 271.946 Mot.Nr.→3085 3899	4	ZS 053	GS 21
C 180 Kompressor	1.8	105	11.06–05.08	M 271.946 Mot.Nr.3085 3900→	4	ZS 077	GS 21
C 200 CGI Kompressor	1.8	125	03.03–11.06	M 271.942 Mot.Nr.→3085 3899	4	ZS 053	GS 21
C 200 CGI Kompressor	1.8	125	11.06–05.08	M 271.942 Mot.Nr.3085 3900→	4	ZS 077	GS 21
C 200 Kompressor	1.8	120	05.02–11.06	M 271.940 Mot.Nr.→3085 3899	4	ZS 053	GS 21
C 200 Kompressor	1.8	120	11.06–05.08	M 271.940 Mot.Nr.3085 3900→	4	ZS 077	GS 21
C 200 Kompressor	2.0	120	03.01–05.02	M 111.955	4	ZS 041	GS 17
C 230	2.5	150	01.05–05.08	M 272.920	6	ZSE 140	
C 230 Kompressor	1.8	141	05.02–11.06	M 271.948 Mot.Nr.→3085 3899	4	ZS 053	GS 21
C 230 Kompressor	1.8	141	11.06–05.08	M 271.948 Mot.Nr.3085 3900→	4	ZS 077	GS 21
C 230 Kompressor	2.3	145	03.01–05.02	M 111.981	4	ZS 041	GS 17
C 320	3.2	160	09.02–05.08	M 112.946	6	ZS 297	
C 350	3.5	200	01.05–05.08	M 272.960	6	ZSE 140	

**C-KLASSE (W204)**

C 180 CGI	1.8	115	01.07–	M 271.820	4	ZS 077	GS 21
C 180 Kompressor	1.6	115	01.08–	M 271.910	4	ZS 077	GS 21
C 180 Kompressor	1.8	115	01.07–	M 271.952 Mot.Nr.3085 3900→	4	ZS 077	GS 21
C 200 CGI	1.8	135	01.07–	M 271.820	4	ZS 077	GS 21
C 200 Kompressor	1.8	135	01.07–	M 271.950 Mot.Nr.3085 3900→	4	ZS 077	GS 21
C 230	2.5	150	01.07–	M 272.921	6	ZSE 140	
C 230 4-matic	2.5	150	07.07–	M 272.911	6	ZSE 140	
C 250 CGI	1.8	150	07.09–	M 271.860	4	ZS 077	GS 21
C 280	3.0	170	01.07–	M 272.947	6	ZSE 140	
C 280 4-matic	3.0	170	07.07–	M 272.948	6	ZSE 140	
C 300	3.0	170	07.09–	M 272.947	6	ZSE 140	
C 300 4-matic	3.0	170	07.07–	M 272.948	6	ZSE 140	
C 350	3.5	200	01.07–	M 272.961	6	ZSE 140	
C 350 4-matic	3.5	200	07.07–	M 272.971	6	ZSE 140	

**C-KLASSE Coupe (C204)**

C 180	1.8	115	06.11–	M 271.820	4	ZS 077	GS 21
C 250	1.8	150	06.11–	M 271.860	4	ZS 077	GS 21

**C-KLASSE Kombi (S204)**

C 180 CGI	1.8	115	11.09–	M 271.820	4	ZS 077	GS 21
C 180 Kompressor	1.6	115	01.08–	M 271.910	4	ZS 077	GS 21
C 180 Kompressor	1.8	115	08.07–	M 271.952 Mot.Nr.3085 3900→	4	ZS 077	GS 21
C 200 Kompressor	1.8	135	08.07–	M 271.950 Mot.Nr.3085 3900→	4	ZS 077	GS 21
C 230	2.5	150	08.07–	M 272.921	6	ZSE 140	
C 250 CGI	1.8	150	07.09–	M 271.860	4	ZS 077	GS 21
C 280	3.0	170	08.07–	M 272.947	6	ZSE 140	
C 350	3.5	200	08.07–	M 272.961	6	ZSE 140	

**CLC-KLASSE (CL203)**

CLC 180 Kompressor	1.8	105	05.08–06.11	M 271.946	4	ZS 077	GS 21
--------------------	-----	-----	-------------	-----------	---	--------	-------



kW

**MERCEDES-BENZ**
**CLC-KLASSE (CL203)**

CLC 200 Kompressor	1.8	135	05.08-06.11	M 271.955	4		<b>ZS 077</b>	<b>GS 21</b>
CLC 230	2.5	150	05.08-06.11	M 272.920	6		<b>ZSE 140</b>	
CLC 350	3.5	200	05.08-06.11	M 272.960	6		<b>ZSE 140</b>	

**CLK (C208)**

200	2.0	100	06.97-06.02	M 111.941	4		<b>ZS 313</b>	
200	2.0	100	06.97-06.02	M 111.945	4		<b>ZS 340</b>	<b>ZLE 234</b>
200 Kompressor	2.0	120	06.00-06.02	M 111.956	4		<b>ZS 041</b>	<b>GS 17</b>
200 Kompressor	2.0	141	06.97-06.00	M 111.944	4		<b>ZS 340</b>	<b>ZLE 234</b>
230 Kompressor	2.3	142	06.97-06.00	M 111.975/M 111.973	4		<b>ZS 340</b>	<b>ZLE 234</b>
230 Kompressor	2.3	145	06.00-06.02	M 111.982	4		<b>ZS 041</b>	<b>GS 17</b>
320	3.2	160	06.97-06.02	M 112.940	6		<b>ZS 297</b>	
430	4.3	205	07.98-06.02	M 113.943	8		<b>ZS 297</b>	
55 AMG	5.4	255	08.99-06.02	M 113.981/M 113.984	8		<b>ZS 297</b>	

**CLK (C209)**

200 CGI	1.8	125	07.03-11.06	M 271.942 Mot.Nr.→3085 3899	4		<b>ZS 053</b>	<b>GS 21</b>
200 CGI	1.8	125	11.06-05.09	M 271.942 Mot.Nr.3085 3900→	4		<b>ZS 077</b>	<b>GS 21</b>
200 Kompressor	1.8	120	09.02-11.06	M 271.940 Mot.Nr.→3085 3899	4		<b>ZS 053</b>	<b>GS 21</b>
200 Kompressor	1.8	120	11.06-05.09	M 271.940 Mot.Nr.3085 3900→	4		<b>ZS 077</b>	<b>GS 21</b>
200 Kompressor	1.8	135	10.06-05.09	M 271.955 Mot.Nr.→3085 3899	4		<b>ZS 053</b>	<b>GS 21</b>
200 Kompressor	1.8	135	10.06-05.09	M 271.955 Mot.Nr.3085 3900→	4		<b>ZS 077</b>	<b>GS 21</b>
240	2.6	125	06.02-05.09	M 112.912	6		<b>ZS 297</b>	
280	3.0	170	01.05-05.09	M 272.940	6		<b>ZSE 140</b>	
320	3.2	160	06.02-05.09	M 112.955	6		<b>ZS 297</b>	
350	3.5	200	01.05-05.09	M 272.960	6		<b>ZSE 140</b>	
500	5.0	225	06.02-05.09	M 113.968	8		<b>ZS 297</b>	
500	5.5	285	06.06-05.09	M 273.965	8		<b>ZSE 140</b>	
55 AMG	5.4	270	09.02-05.09	M 113.987	8		<b>ZS 297</b>	

**CLK Cabriolet (A208)**

200	2.0	100	03.98-03.02	M 111.941	4		<b>ZS 313</b>	
200	2.0	100	03.98-03.02	M 111.945	4		<b>ZS 340</b>	<b>ZLE 234</b>
200 Kompressor	2.0	120	06.00-03.02	M 111.956	4		<b>ZS 041</b>	<b>GS 17</b>
200 Kompressor	2.0	141	03.98-06.00	M 111.944	4		<b>ZS 340</b>	<b>ZLE 234</b>
230 Kompressor	2.3	142	03.98-06.00	M 111.975/M 111.973	4		<b>ZS 340</b>	<b>ZLE 234</b>
230 Kompressor	2.3	145	06.00-03.02	M 111.982	4		<b>ZS 041</b>	<b>GS 17</b>
320	3.2	160	03.98-03.02	M 112.940	6		<b>ZS 297</b>	
430	4.3	205	09.98-03.02	M 113.943	8		<b>ZS 297</b>	

**CLK Cabriolet (A209)**

CLK 200 Kompressor	1.8	120	02.03-11.06	M 271.940 Mot.Nr.→3085 3899	4		<b>ZS 053</b>	<b>GS 21</b>
CLK 200 Kompressor	1.8	120	11.06-03.10	M 271.940 Mot.Nr.3085 3900→	4		<b>ZS 077</b>	<b>GS 21</b>
CLK 200 Kompressor	1.8	135	10.06-03.10	M 271.955 Mot.Nr.→3085 3899	4		<b>ZS 053</b>	<b>GS 21</b>
CLK 200 Kompressor	1.8	135	10.06-03.10	M 271.955 Mot.Nr.3085 3900→	4		<b>ZS 077</b>	<b>GS 21</b>
CLK 240	2.6	125	02.03-03.10	M 112.912	6		<b>ZS 297</b>	
CLK 280	3.0	170	01.05-03.10	M 272.940	6		<b>ZSE 140</b>	
CLK 320	3.2	160	02.03-03.10	M 112.955	6		<b>ZS 297</b>	
CLK 350	3.5	200	01.05-03.10	M 272.960	6		<b>ZSE 140</b>	
CLK 500	5.0	225	02.03-03.10	M 113.968	8		<b>ZS 297</b>	
CLK 500	5.5	285	06.06-03.10	M 273.967	8		<b>ZSE 140</b>	
CLK 55 AMG	5.4	270	02.03-03.10	M 113.987	8		<b>ZS 297</b>	

**CLS (C219)**

CLS 280	3.0	170	07.08-12.10	M 272.943	6		<b>ZSE 140</b>	
CLS 300	3.0	170	04.09-12.10	M 272.943	6		<b>ZSE 140</b>	
CLS 350	3.5	200	10.04-12.10	M 272.964	6		<b>ZSE 140</b>	
CLS 500	5.5	285	04.06-12.10	M 273.960	8		<b>ZSE 140</b>	



kW



**MERCEDES-BENZ**

**E-KLASSE (W124)**

E 200	2.0	100	06.93-06.95	M 111.940	4		<b>ZS 313</b>	
E 220	2.2	110	06.93-06.95	M 111.960	4		<b>ZS 313</b>	
E 280	2.8	145	06.93-06.95	M 104.942	6		<b>ZS 340</b>	<b>ZLE 234</b>
E 300 4-matic	3.0	132	06.93-06.95	M 103.985	6		<b>ZS 296</b>	
E 320	3.2	162	06.93-06.95	M 104.992	6		<b>ZS 340</b>	<b>ZLE 234</b>
E 420	4.2	205	06.93-06.95	M 119.975	8	<b>ZM 004</b>	<b>ZS 298<sup>290</sup></b>	
E 420	4.2	205	06.93-06.95	M 119.975	8		<b>ZS 299<sup>289</sup></b>	
E 500	5.0	235	06.93-06.95	M 119.974	8		<b>ZS 296</b>	
E 60 AMG	6.0	280	05.94-06.95	M 119.974 AMG	8		<b>ZS 296</b>	

**E-KLASSE Cabriolet (A124)**

E 200	2.0	100	06.93-08.95	M 111.940	4		<b>ZS 313</b>	
E 200	2.0	100	09.95-03.98	M 111.940	4		<b>ZS 340</b>	<b>ZLE 234</b>
E 220	2.2	110	06.93-08.95	M 111.960	4		<b>ZS 313</b>	
E 220	2.2	110	09.95-03.98	M 111.960	4		<b>ZS 340</b>	<b>ZLE 234</b>
E 320	3.2	162	06.93-03.98	M 104.992/M 104.995	6		<b>ZS 340</b>	<b>ZLE 234</b>
E 36 AMG	3.6	200	05.94-03.98	M 104.992 (AMG 3.6)	6		<b>ZS 340</b>	<b>ZLE 234</b>

**E-KLASSE Coupe (C124)**

E 200	2.0	100	06.93-08.95	M 111.940	4		<b>ZS 313</b>	
E 200	2.0	100	09.95-06.97	M 111.940	4		<b>ZS 340</b>	<b>ZLE 234</b>
E 220	2.2	110	06.93-08.95	M 111.960	4		<b>ZS 313</b>	
E 220	2.2	110	09.95-06.97	M 111.960	4		<b>ZS 340</b>	<b>ZLE 234</b>
E 320	3.2	162	06.93-06.97	M 104.992	6		<b>ZS 340</b>	<b>ZLE 234</b>
E 36 AMG	3.6	195	06.93-04.95	M 104.992 (AMG 3.6)	6		<b>ZS 340</b>	<b>ZLE 234</b>
E 36 AMG	3.6	200	05.94-06.97	M 104.992 (AMG 3.6)	6		<b>ZS 340</b>	<b>ZLE 234</b>

**E-KLASSE Kombi (S124)**

E 200 T	2.0	100	06.93-06.96	M 111.940	4		<b>ZS 313</b>	
E 220 T	2.2	110	06.93-06.96	M 111.960	4		<b>ZS 313</b>	
E 280 T	2.8	142	06.93-06.96	M 104.942	6		<b>ZS 340</b>	<b>ZLE 234</b>
E 280 T	2.8	145	06.93-06.96	M 104.942	6		<b>ZS 340</b>	<b>ZLE 234</b>
E 300 T 4-matic	3.0	132	06.93-06.96	M 103.985	6		<b>ZS 296</b>	
E 320 T	3.2	162	06.93-06.96	M 104.992	6		<b>ZS 340</b>	<b>ZLE 234</b>
E 36 T AMG	3.6	200	05.94-06.96	M 104.992 (AMG 3.6)	6		<b>ZS 340</b>	<b>ZLE 234</b>

**E-KLASSE (W210)**

E 200	2.0	100	06.95-08.00	M 111.942	4		<b>ZS 340</b>	<b>ZLE 234</b>
E 200 Kompressor	2.0	120	08.00-03.02	M 111.957	4		<b>ZS 041</b>	<b>GS 17</b>
E 200 Kompressor	2.0	137	06.97-03.02	M 111.947	4		<b>ZS 340</b>	<b>ZLE 234</b>
E 230	2.3	110	06.95-06.97	M 111.970	4		<b>ZS 340</b>	<b>ZLE 234</b>
E 240	2.4	125	06.97-06.99	M 112.911	6		<b>ZS 297</b>	
E 240	2.6	125	08.00-03.02	M 112.914	6		<b>ZS 297</b>	
E 280	2.8	142	01.96-06.97	M 104.945	6		<b>ZS 340</b>	<b>ZLE 234</b>
E 280	2.8	150	12.96-03.02	M 112.921	6		<b>ZS 297</b>	
E 280 4-matic	2.8	150	12.96-06.99	M 112.921	6		<b>ZS 297</b>	
E 320	3.2	162	06.95-06.97	M 104.995	6		<b>ZS 340</b>	<b>ZLE 234</b>
E 320	3.2	165	06.97-03.02	M 112.941	6		<b>ZS 297</b>	
E 320 4-matic	3.2	165	06.97-03.02	M 112.941	6		<b>ZS 297</b>	
E 430	4.3	205	06.97-03.02	M 113.940	8		<b>ZS 297</b>	
E 430 4-matic	4.3	205	05.99-03.02	M 113.940	8		<b>ZS 297</b>	
E 55 AMG	5.4	260	08.97-03.02	M 113.980	8		<b>ZS 297</b>	

**E-KLASSE Kombi (S210)**

E 200 T	2.0	100	06.96-08.00	M 111.942	4		<b>ZS 340</b>	<b>ZLE 234</b>
E 200 T Kompressor	2.0	120	08.00-03.03	M 111.957	4		<b>ZS 041</b>	<b>GS 17</b>
E 200 T Kompressor	2.0	137	06.97-03.03	M 111.947	4		<b>ZS 340</b>	<b>ZLE 234</b>
E 230 T	2.3	110	06.96-06.97	M 111.970	4		<b>ZS 340</b>	<b>ZLE 234</b>
E 240 T	2.4	125	06.97-03.03	M 112.911	6		<b>ZS 297</b>	
E 240 T	2.6	125	08.00-03.03	M 112.914	6		<b>ZS 297</b>	
E 280 T	2.8	150	12.96-03.03	M 112.921	6		<b>ZS 297</b>	
E 280 T 4-matic	2.8	150	12.96-03.03	M 112.921	6		<b>ZS 297</b>	
E 320 T	3.2	165	12.96-03.03	M 112.941	6		<b>ZS 297</b>	
E 320 T 4-matic	3.2	165	12.96-03.03	M 112.941	6		<b>ZS 297</b>	
E 430 T	4.3	205	06.97-03.03	M 113.940	8		<b>ZS 297</b>	
E 430 T 4-matic	4.3	205	05.99-03.03	M 113.940	8		<b>ZS 297</b>	



kW

**MERCEDES-BENZ**
**E-KLASSE Kombi (S210)**

E 55 T AMG	5.4	260	08.97–03.03	M 113.980	8		<b>ZS 297</b>	
------------	-----	-----	-------------	-----------	---	--	---------------	--

**E-KLASSE (W211)**

E 200 CGI	1.8	125	11.02–11.06	M 271.946 Mot.Nr.→3085 3899	4		<b>ZS 053</b>	<b>GS 21</b>
-----------	-----	-----	-------------	--------------------------------	---	--	---------------	--------------

E 200 CGI	1.8	125	11.06–12.08	M 271.946 Mot.Nr.3085 3900→	4		<b>ZS 077</b>	<b>GS 21</b>
-----------	-----	-----	-------------	--------------------------------	---	--	---------------	--------------

E 200 Kompressor	1.8	120	11.02–11.06	M 271.941 Mot.Nr.→3085 3899	4		<b>ZS 053</b>	<b>GS 21</b>
------------------	-----	-----	-------------	--------------------------------	---	--	---------------	--------------

E 200 Kompressor	1.8	120	11.06–12.08	M 271.941 Mot.Nr.3085 3900→	4		<b>ZS 077</b>	<b>GS 21</b>
------------------	-----	-----	-------------	--------------------------------	---	--	---------------	--------------

E 200 Kompressor	1.8	135	04.06–11.06	M 271.956 Mot.Nr.→3085 3899	4		<b>ZS 053</b>	<b>GS 21</b>
------------------	-----	-----	-------------	--------------------------------	---	--	---------------	--------------

E 200 Kompressor	1.8	135	11.06–12.08	M 271.956 Mot.Nr.3085 3900→	4		<b>ZS 077</b>	<b>GS 21</b>
------------------	-----	-----	-------------	--------------------------------	---	--	---------------	--------------

E 230	2.5	150	09.07–12.08	M 272.922	6		<b>ZSE 140</b>	
-------	-----	-----	-------------	-----------	---	--	----------------	--

E 240	2.6	130	03.02–12.08	M 112.917/M 112.913	6		<b>ZS 297</b>	
-------	-----	-----	-------------	---------------------	---	--	---------------	--

E 240 4-matic	2.6	130	03.03–12.08	M 112.917	6		<b>ZS 297</b>	
---------------	-----	-----	-------------	-----------	---	--	---------------	--

E 280	3.0	170	03.05–12.08	M 272.943	6		<b>ZSE 140</b>	
-------	-----	-----	-------------	-----------	---	--	----------------	--

E 280 4-matic	3.0	170	01.06–12.08	M 272.943	6		<b>ZSE 140</b>	
---------------	-----	-----	-------------	-----------	---	--	----------------	--

E 320	3.2	165	03.02–12.08	M 112.949	6		<b>ZS 297</b>	
-------	-----	-----	-------------	-----------	---	--	---------------	--

E 320 4-matic	3.2	165	03.03–12.08	M 112.954	6		<b>ZS 297</b>	
---------------	-----	-----	-------------	-----------	---	--	---------------	--

E 350	3.5	200	03.05–12.08	M 272.964	6		<b>ZSE 140</b>	
-------	-----	-----	-------------	-----------	---	--	----------------	--

E 350 4-matic	3.5	200	03.05–12.08	M 272.964/M 272.972	6		<b>ZSE 140</b>	
---------------	-----	-----	-------------	---------------------	---	--	----------------	--

E 500	5.0	225	03.02–12.08	M 113.967	8		<b>ZS 297</b>	
-------	-----	-----	-------------	-----------	---	--	---------------	--

E 500	5.5	285	04.06–12.08	M 273.960	8		<b>ZSE 140</b>	
-------	-----	-----	-------------	-----------	---	--	----------------	--

E 500 4-matic	5.0	225	10.03–12.08	M 113.969	8		<b>ZS 297</b>	
---------------	-----	-----	-------------	-----------	---	--	---------------	--

E 500 4-matic	5.5	285	04.06–12.08	M 273.962	8		<b>ZSE 140</b>	
---------------	-----	-----	-------------	-----------	---	--	----------------	--

E 55 AMG Kompressor	5.4	350	10.02–12.08	M 113.990	8		<b>ZS 297</b>	
---------------------	-----	-----	-------------	-----------	---	--	---------------	--

E200 NGT	1.8	120	03.04–12.08	M 271.941 Mot.Nr.→3085 3899	4		<b>ZS 053</b>	<b>GS 21</b>
----------	-----	-----	-------------	--------------------------------	---	--	---------------	--------------

E200 NGT	1.8	120	03.04–12.08	M 271.941 Mot.Nr.3085 3900→	4		<b>ZS 077</b>	<b>GS 21</b>
----------	-----	-----	-------------	--------------------------------	---	--	---------------	--------------

**E-KLASSE Kombi (S211)**

E 200 Kompressor	1.8	135	04.06–11.06	M 271.956 Mot.Nr.→3085 3899	4		<b>ZS 053</b>	<b>GS 21</b>
------------------	-----	-----	-------------	--------------------------------	---	--	---------------	--------------

E 200 Kompressor	1.8	135	11.06–07.09	M 271.956 Mot.Nr.3085 3900→	4		<b>ZS 077</b>	<b>GS 21</b>
------------------	-----	-----	-------------	--------------------------------	---	--	---------------	--------------

E 200 T Kompressor	1.8	120	03.03–11.06	M 271.941 Mot.Nr.→3085 3899	4		<b>ZS 053</b>	<b>GS 21</b>
--------------------	-----	-----	-------------	--------------------------------	---	--	---------------	--------------

E 200 T Kompressor	1.8	120	11.06–07.09	M 271.941 Mot.Nr.3085 3900→	4		<b>ZS 077</b>	<b>GS 21</b>
--------------------	-----	-----	-------------	--------------------------------	---	--	---------------	--------------

E 230 T	2.5	150	05.07–07.09	M 272.922	6		<b>ZSE 140</b>	
---------	-----	-----	-------------	-----------	---	--	----------------	--

E 240 T	2.6	130	03.03–07.09	M 112.913	6		<b>ZS 297</b>	
---------	-----	-----	-------------	-----------	---	--	---------------	--

E 240 T 4-matic	2.6	130	07.03–07.09	M 112.917	6		<b>ZS 297</b>	
-----------------	-----	-----	-------------	-----------	---	--	---------------	--

E 280 T	3.0	170	03.05–07.09	M 272.943	6		<b>ZSE 140</b>	
---------	-----	-----	-------------	-----------	---	--	----------------	--

E 280 T 4-matic	3.0	170	03.05–07.09	M 272.943	6		<b>ZSE 140</b>	
-----------------	-----	-----	-------------	-----------	---	--	----------------	--

E 320 T	3.2	165	03.03–07.09	M 112.949	6		<b>ZS 297</b>	
---------	-----	-----	-------------	-----------	---	--	---------------	--

E 320 T 4-matic	3.2	165	07.03–07.09	M 112.954	6		<b>ZS 297</b>	
-----------------	-----	-----	-------------	-----------	---	--	---------------	--

E 350 T	3.5	200	03.05–07.09	M 272.964/M 272.972	6		<b>ZSE 140</b>	
---------	-----	-----	-------------	---------------------	---	--	----------------	--

E 350 T 4-matic	3.5	200	03.05–07.09	M 272.964/M 272.972	6		<b>ZSE 140</b>	
-----------------	-----	-----	-------------	---------------------	---	--	----------------	--

E 500 T	5.0	225	10.03–07.09	M 113.967	8		<b>ZS 297</b>	
---------	-----	-----	-------------	-----------	---	--	---------------	--

E 500 T	5.5	285	04.06–07.09	M 273.960	8		<b>ZSE 140</b>	
---------	-----	-----	-------------	-----------	---	--	----------------	--

E 500 T 4-matic	5.0	225	10.03–07.09	M 113.969	8		<b>ZS 297</b>	
-----------------	-----	-----	-------------	-----------	---	--	---------------	--

E 500 T 4-matic	5.5	285	04.06–07.09	M 273.962	8		<b>ZSE 140</b>	
-----------------	-----	-----	-------------	-----------	---	--	----------------	--

E 55 T AMG Kompressor	5.4	350	07.03–07.09	M 113.990	8		<b>ZS 297</b>	
-----------------------	-----	-----	-------------	-----------	---	--	---------------	--

**E-KLASSE (W212)**

E 200 CGI	1.8	135	08.09–	M 271.820/M 271.860	4		<b>ZS 077</b>	<b>GS 21</b>
-----------	-----	-----	--------	---------------------	---	--	---------------	--------------

E 200 NGT	1.8	120	03.11–	M 271.958	4		<b>ZS 077</b>	<b>GS 21</b>
-----------	-----	-----	--------	-----------	---	--	---------------	--------------

E 250 CGI	1.8	150	01.09–	M 271.860	4		<b>ZS 077</b>	<b>GS 21</b>
-----------	-----	-----	--------	-----------	---	--	---------------	--------------

E 350	3.5	200	01.09–	M 272.980	6		<b>ZSE 140</b>	
-------	-----	-----	--------	-----------	---	--	----------------	--

E 350 4-matic	3.5	200	01.09–08.11	M 272.977	6		<b>ZSE 140</b>	
---------------	-----	-----	-------------	-----------	---	--	----------------	--

E 500	5.5	285	01.09–	M 273.971	8		<b>ZSE 140</b>	
-------	-----	-----	--------	-----------	---	--	----------------	--

E 500 4-matic	5.5	285	01.09–	M 273.970	8		<b>ZSE 140</b>	
---------------	-----	-----	--------	-----------	---	--	----------------	--



kW



**MERCEDES-BENZ**

**E-KLASSE Kombi (S212)**

E 200 CGI	1.8	135	11.09-	M 271.820/M 271.860	4		ZS 077	GS 21
E 250 CGI	1.8	150	11.09-	M 271.860	4		ZS 077	GS 21
E 350	3.5	200	08.09-	M 272.980	6		ZSE 140	
E 350 4-matic	3.5	200	11.09-	M 272.977	6		ZSE 140	
E 500	5.5	285	11.09-	M 273.971	8		ZSE 140	

**E-KLASSE Cabriolet (A207)**

E 200 CGI	1.8	135	01.10-	M 271.820/M 271.860	4		ZS 077	GS 21
E 250 CGI	1.8	150	01.10-	M 271.860	4		ZS 077	GS 21
E 500	5.5	285	01.10-	M 273.966	8		ZSE 140	

**E-KLASSE Coupe (C207)**

E 200 CGI	1.8	135	01.10-	M 271.820/M 271.860	4		ZS 077	GS 21
E 250 CGI	1.8	150	01.09-	M 271.860	4		ZS 077	GS 21
E 500	5.5	285	01.09-	M 273.966	8		ZSE 140	

**G-KLASSE (W460)**

230 G	2.3	66	03.79-07.93	M 115.973	4		ZS 109	
230 G	2.3	75	02.80-07.87	M 115.973	4		ZS 109	
230 GE	2.3	90	05.87-08.89	M102.987	4	ZM 004		
230 GE	2.3	92	04.82-08.92	M 102.987/M 102.981/M 102.989	4	ZM 004	ZS 117	
280 GE	2.7	110	08.84-08.89	M 110.994	6	ZM 004	ZS 117	
280 GE	2.7	115	11.79-08.89	M 110.994	6	ZM 004	ZS 117	

**G-KLASSE (W463)**

230 GE	2.3	93	06.90-06.93	M 102.989	4		ZS 339	
300 GE	3.0	125	06.90-10.94	M 103.987	6		ZS 339	
300 GE	3.0	128	06.90-08.93	M 103.987	6		ZS 339 <sup>202</sup>	
300 GE	3.0	128	06.90-	M 103.987	6		ZS 339 <sup>202</sup>	
G 320	3.2	155	09.94-12.97	M 104.996	6		ZS 340	ZLE 234
G 320	3.2	158	07.97-	M 112.945	6		ZS 297	
G 36 AMG	3.6	200	01.95-		6		ZS 340	ZLE 234
G 500	5.0	218	04.98-	M 113.962	8		ZS 297	
G 500 E	5.0	177	09.93-	M 117.965	8		ZS 298	
G 55 AMG	5.4	260	04.99-	M 113.982	8		ZS 297	
G 55 AMG	5.4	350	06.04-	M 113.993	8		ZS 297	

**GL-KLASSE (X164)**

GL 450	4.7	250	09.06-	M 273.923	8		ZSE 140	
GL 500	5.5	285	09.06-	M 273.963	8		ZSE 140	

**GLK-KLASSE (X204)**

300 4-matic	3.0	170	07.09-04.11	M 272.948	6		ZSE 140	
350 4-matic	3.5	200	06.08-04.11	M 272.971	6		ZSE 140	

**M-KLASSE (W163)**

ML 230	2.3	110	02.98-06.05	M 111.977	4		ZS 340	ZLE 234
ML 320	3.2	160	02.98-08.02	M 112.942	6		ZS 297	
ML 350	3.7	173	02.03-06.05	M 112.970	6		ZS 297	
ML 350	3.7	180	08.02-06.05	M 112.970	6		ZS 297	
ML 430	4.3	200	02.98-06.05	M 113.942	8		ZS 297	
ML 500	5.0	215	09.01-06.05	M 113.964/M 113.965	8		ZS 297	
ML 55 AMG	5.4	255	02.00-06.05	M 113.981	8		ZS 297	

**M-KLASSE (W164)**

ML 350 4-matic	3.5	200	07.05-	M 272.962/M 272.967	6		ZSE 140	
ML 500 4-matic	5.0	225	07.05-	M 113.964	8		ZS 297	
ML 500 4-matic	5.5	285	12.07-	M 273.963	8		ZSE 140	

**R-KLASSE (W251, V251)**

R 280	3.0	170	01.07-	M 272.945	6		ZSE 140	
R 300	3.0	170	07.09-	M 272.945	6		ZSE 140	
R 350	3.5	200	01.07-	M 272.967	6		ZSE 140	
R 350 4-matic	3.5	200	01.06-	M 272.967	6		ZSE 140	
R 500 4-matic	5.0	225	01.06-	M 113.971	8		ZS 297	
R 500 4-matic	5.5	285	01.07-	M 273.963	8		ZSE 140	

**S-KLASSE (W126)**

260 SE	2.6	118	09.85-06.91	M 103.941	6		ZS 296	
260 SE	2.6	118	09.85-06.91	M 103.941	6		ZS 339	
260 SE	2.6	122	09.85-06.91	M 103.941	6		ZS 296	



kW

**MERCEDES-BENZ**
**S-KLASSE (W126)**

260 SE	2.6	122	09.85-06.91	M 103.941	6		<b>ZS 339</b>	
280 S	2.7	115	12.79-07.85	M 110.926/M 110.924	6	<b>ZM 004</b>	<b>ZS 400</b>	
280 S	2.7	115	12.79-07.85	M 110.926/M 110.924	6	<b>ZM 004</b>	<b>ZS 117</b>	
280 SE,SEL	2.7	136	09.81-07.85	M 110.987/M 110.989	6	<b>ZM 004</b>		
280 SE,SEL	2.7	136	10.79-07.85	M 110.987/M 110.989	6		<b>ZS 400</b>	
280 SE,SEL	2.7	136	10.79-07.85	M 110.987/M 110.989	6		<b>ZS 117</b>	
300 SE,SEL	3.0	132	01.86-06.91	M 103.981	6		<b>ZS 296</b>	
300 SE,SEL	3.0	132	01.86-06.91	M 103.981	6		<b>ZS 339</b>	
300 SE,SEL	3.0	138	09.85-12.89	M 103.981	6		<b>ZS 296</b> <sup>202</sup>	
300 SE,SEL	3.0	138	09.85-12.89	M 103.981	6		<b>ZS 339</b> <sup>202</sup>	
380 SE,SEL	3.8	150	09.81-08.85	M 116.963	8	<b>ZM 004</b>		
380 SE,SEL	3.8	150	12.79-08.85	M 116.963	8		<b>ZS 118</b>	
420 SE,SEL	4.2	150	10.85-06.91	M 116.965	8		<b>ZS 298</b>	
420 SE,SEL	4.2	160	10.85-12.87	M 116.965	8		<b>ZS 298</b>	
420 SE,SEL	4.2	165	10.85-06.91	M 116.965	8		<b>ZS 298</b>	
420 SE,SEL	4.2	170	10.85-12.87	M 116.965	8		<b>ZS 298</b>	
500 SE,SEL	5.0	164	09.85-06.91	M 117.965	8		<b>ZS 298</b>	
500 SE,SEL	5.0	170	09.81-08.85	M 117.961/M 117.963	8	<b>ZM 004</b>		
500 SE,SEL	5.0	170	12.79-08.85	M 117.961/M 117.963 Fgst.Nr.13681→	8		<b>ZS 118</b>	
500 SE,SEL	5.0	170	12.79-08.85	M 117.961/M 117.963	8		<b>ZS 400</b>	
500 SE,SEL	5.0	177	09.81-08.85	M 117.961/M 117.963	8	<b>ZM 004</b>		
500 SE,SEL	5.0	177	12.79-08.85	M 117.961/M 117.963	8		<b>ZS 400</b>	
500 SE,SEL	5.0	177	12.79-08.85	M 117.961/M 117.963	8		<b>ZS 118</b>	
500 SE,SEL	5.0	180	09.85-06.91	M 117.965	8		<b>ZS 298</b>	
500 SE,SEL	5.0	185	09.87-06.91	M 117.965	8		<b>ZS 298</b>	
500 SE,SEL	5.0	195	09.87-06.91	M 117.965	8		<b>ZS 298</b>	
500 SE,SEL KAT	5.0	185	06.89-06.91	M 117.965	8		<b>ZS 298</b>	
560 SE,SEL	5.5	178	10.85-06.91	M 117.968	8		<b>ZS 298</b>	
560 SE,SEL	5.5	200	10.85-12.87	M 117.968	8		<b>ZS 298</b>	
560 SE,SEL	5.5	205	08.87-06.91	M 117.968	8		<b>ZS 298</b>	
560 SE,SEL	5.5	220	10.85-08.87	M 117.968	8		<b>ZS 298</b>	

**S-KLASSE Coupe (C126)**

380 SEC	3.8	150	10.81-07.85	M 116.963	8	<b>ZM 004</b>	<b>ZS 118</b>	
420 SEC	4.2	150	10.85-06.91	M 116.965	8		<b>ZS 298</b>	
420 SEC	4.2	160	10.85-12.87	M 116.965	8		<b>ZS 298</b>	
420 SEC	4.2	165	10.85-06.91	M 116.965	8		<b>ZS 298</b>	
500 SEC	5.0	164	10.85-06.91	M 117.965	8		<b>ZS 298</b>	
500 SEC	5.0	170	10.81-08.85	M 117.963	8	<b>ZM 004</b>	<b>ZS 118</b>	
500 SEC	5.0	180	09.85-06.91	M 117.965	8		<b>ZS 298</b>	
500 SEC	5.0	185	08.87-06.91	M 117.965	8		<b>ZS 298</b>	
500 SEC	5.0	195	09.85-06.91	M 117.965	8		<b>ZS 298</b>	
500 SEC KAT	5.0	185	06.89-06.91	M 117.965	8		<b>ZS 298</b>	
560 SEC	5.5	178	10.85-06.91	M 117.968	8		<b>ZS 298</b>	
560 SEC	5.5	200	10.85-12.87	M 117.968	8		<b>ZS 298</b>	
560 SEC	5.5	205	10.85-06.91	M 117.968	8		<b>ZS 298</b>	
560 SEC	5.5	220	10.85-08.87	M 117.968	8		<b>ZS 298</b>	

**S-KLASSE (W140)**

300 SE 2.8	2.8	145	01.93-10.98	M 104.944	6		<b>ZS 340</b>	<b>ZLE 234</b>
300 SE,SEL/S320	3.2	170	03.91-10.98	M 104.994	6		<b>ZS 340</b>	<b>ZLE 234</b>
400 SE,SEL/S420	4.2	210	02.91-10.98	M 119.971	8		<b>ZS 296</b> <sup>280</sup>	
400 SE,SEL/S420	4.2	210	02.91-10.98	M 119.971	8		<b>ZS 339</b> <sup>281</sup>	
500 SE,SEL	5.0	240	02.91-10.98	M 119.970	8		<b>ZS 296</b> <sup>280</sup>	
500 SE,SEL	5.0	240	02.91-10.98	M 119.970	8		<b>ZS 339</b> <sup>281</sup>	
600 SE,SEL	6.0	300	04.91-12.92	M 120.982/M 120.980	12		<b>ZS 296</b> <sup>280</sup>	
600 SE,SEL	6.0	300	04.91-12.92	M 120.982/M 120.980	12		<b>ZS 339</b> <sup>281</sup>	
S 280	2.8	142	02.93-10.98	M 104.944	6		<b>ZS 340</b>	<b>ZLE 234</b>
S 420	4.2	205	01.93-10.98	M 119.971	8		<b>ZS 296</b> <sup>280</sup>	
S 420	4.2	205	01.93-10.98	M 119.971	8		<b>ZS 339</b> <sup>281</sup>	
S 500	5.0	235	01.93-10.98	M 119.970/M 119.980	8		<b>ZS 296</b> <sup>280</sup>	
S 500	5.0	235	01.93-10.98	M 119.970/M 119.980	8		<b>ZS 339</b> <sup>281</sup>	



kW



**MERCEDES-BENZ**

**S-KLASSE (W140)**

S 600	6.0	290	01.93-10.98	M 120.982/M 120.980	12		<b>ZS 296<sup>280</sup></b>
S 600	6.0	290	01.93-10.98	M 120.982/M 120.980	12		<b>ZS 339<sup>281</sup></b>

**S-KLASSE Coupe (C140)**

SEC/CL 420	4.2	205	10.94-02.99	M 119.971/M 119.981	8		<b>ZS 299</b>
SEC/CL 500	5.0	235	10.92-09.95	M 119.970 Fgst.Nr.→A 290166	8		<b>ZS 299</b>
SEC/CL 600	6.0	290	09.92-09.95	M 120.982/M 120.980 Fgst.Nr.→A 290166	12		<b>ZS 296<sup>280</sup></b>
SEC/CL 600	6.0	290	09.92-09.95	M 120.982/M 120.980 Fgst.Nr.→A 290166	12		<b>ZS 339<sup>281</sup></b>

**S-KLASSE (W220)**

S 280	2.8	150	10.98-08.05	M 112.922	6		<b>ZS 297</b>
S 320	3.2	165	10.98-08.05	M 112.944	6		<b>ZS 297</b>
S 350	3.7	180	09.02-08.05	M 112.972	6		<b>ZS 297</b>
S 350 4-matic	3.7	180	06.03-08.05	M 112.975	6		<b>ZS 297</b>
S 430	4.3	205	10.98-08.05	M 113.941	8		<b>ZS 297</b>
S 430 4-matic	4.3	205	09.02-08.05	M 113.948	8		<b>ZS 297</b>
S 500	5.0	225	10.98-08.05	M 113.960	8		<b>ZS 297</b>
S 500 4-matic	5.0	225	09.02-08.05	M 113.966	8		<b>ZS 297</b>
S 55 AMG	5.4	265	04.99-08.05	M 113.986	8		<b>ZS 297</b>
S 55 AMG Kompressor	5.4	368	06.02-08.05	M 113.991	8		<b>ZS 297</b>

**S-KLASSE Coupe (C215)**

CL 500	5.0	225	03.99-03.06	M 113.960	8		<b>ZS 297</b>
CL 55 AMG	5.4	265	10.99-03.06	M 113.986	8		<b>ZS 297</b>
CL 55 AMG Kompressor	5.4	368	06.02-03.06	M 113.991	8		<b>ZS 297</b>

**S-KLASSE (W221)**

S 280	3.0	170	08.06-	M 272.946	6		<b>ZSE 140</b>
S 300	3.0	170	08.06-	M 272.946	6		<b>ZSE 140</b>
S 350	3.5	200	10.05-	M 272.965	6		<b>ZSE 140</b>
S 350 4-matic	3.5	200	02.08-	M 272.975	6		<b>ZSE 140</b>
S 400 Hybrid	3.5	205	01.09-	M 272.974	6		<b>ZSE 140</b>
S 450	4.7	250	12.05-	M 273.922	8		<b>ZSE 140</b>
S 450 4-matic	4.7	250	12.05-	M 273.924	8		<b>ZSE 140</b>
S 500	5.5	285	10.05-	M 273.961	8		<b>ZSE 140</b>
S 500 4-matic	5.5	285	10.05-	M 273.961/M 273.968	8		<b>ZSE 140</b>

**S-KLASSE Coupe (C216)**

CL 500	5.5	285	06.06-	M 273.961	8		<b>ZSE 140</b>
CL 500 4-matic	5.5	285	02.08-	M 273.968	8		<b>ZSE 140</b>

**SL (R107)**

280 SL	2.7	136	08.74-07.85	M 110.986/M 110.990/M 110.982	6	<b>ZM 004</b>	<b>ZS 400</b>
380 SL	3.8	150	09.80-08.85	M 116.962	8	<b>ZM 004</b>	
420 SL	4.2	150	01.86-08.89	M 116.964	8		<b>ZS 299</b>
420 SL	4.2	160	01.86-08.89	M 116.964	8		<b>ZS 299</b>
500 SL	5.0	164	01.86-08.89	M 117.964	8		<b>ZS 299</b>
500 SL	5.0	170	09.81-12.85	M 117.960	8	<b>ZM 004</b>	<b>ZS 118</b>
500 SL	5.0	180	01.86-08.89	M 117.964/M 117.960	8	<b>ZM 004</b>	<b>ZS 299</b>

**SL (R129)**

280	2.8	142	08.93-10.01	M 104.943	6		<b>ZS 340</b>	<b>ZLE 234</b>
280	2.8	150	05.98-10.01	M 112.923/M 112.925	6		<b>ZS 297</b>	
300 SL-24	3.0	170	03.89-07.93	M 104.981	6		<b>ZS 299</b>	
320	3.2	165	05.98-10.01	M 112.943	6		<b>ZS 297</b>	
320	3.2	170	09.93-10.01	M 104.991	6		<b>ZS 340</b>	<b>ZLE 234</b>
500	5.0	225	05.98-10.01	M 113.961	8		<b>ZS 297</b>	
500	5.0	235	09.92-09.95	M 119.982/M 119.972	8		<b>ZS 296<sup>280</sup></b>	
500	5.0	235	09.92-09.95	M 119.982/M 119.972	8		<b>ZS 339<sup>281</sup></b>	
500 SL	5.0	240	09.89-08.92	M 119.960/M 119.972	8		<b>ZS 296<sup>280</sup></b>	
500 SL	5.0	240	09.89-08.92	M 119.960/M 119.972	8		<b>ZS 339<sup>281</sup></b>	
600	6.0	290	07.92-09.95	M 120.983/M 120.981	12		<b>ZS 296<sup>280</sup></b>	
600	6.0	290	07.92-09.95	M 120.983/M 120.981	12		<b>ZS 339<sup>281</sup></b>	

**SL (R230)**

280	3.0	170	03.08-01.12	M 272.949	6		<b>ZSE 140</b>
300	3.0	170	04.09-01.12	M 272.949	6		<b>ZSE 140</b>



kW

**MERCEDES-BENZ**

<b>SL (R230)</b>									
350	3.7	180	03.03-01.12	M 112.973	6			<b>ZS 297</b>	
350	3.5	200	03.06-01.12	M 272.966	6			<b>ZSE 140</b>	
350	3.5	232	04.08-01.12	M 272.968	6			<b>ZSE 140</b>	
500	5.0	225	10.01-01.12	M 113.963	8			<b>ZS 297</b>	
500	5.5	285	03.06-01.12	M 273.965	8			<b>ZSE 140</b>	
55 AMG	5.4	350	10.01-06.02	M 113.992	8			<b>ZS 297</b>	
55 AMG	5.4	380	03.06-01.12	M 113.995	8			<b>ZS 297</b>	
55 AMG Kompressor	5.4	368	06.02-01.12	M 113.992	8			<b>ZS 297</b>	
<b>SLK (R170)</b>									
200	2.0	100	09.96-03.00	M 111.946	4			<b>ZS 340</b>	<b>ZLE 234</b>
200 Kompressor	2.0	120	03.00-04.04	M 111.958	4			<b>ZS 041</b>	<b>GS 17</b>
200 Kompressor	2.0	141	10.96-03.00	M 111.943	4			<b>ZS 340</b>	<b>ZLE 234</b>
230 Kompressor	2.3	142	09.96-03.00	M 111.973	4			<b>ZS 340</b>	<b>ZLE 234</b>
230 Kompressor	2.3	145	03.00-04.04	M 111.983	4			<b>ZS 041</b>	<b>GS 17</b>
32 AMG Kompressor	3.2	260	03.01-04.04	M 112.960	6			<b>ZS 297</b>	
320	3.2	160	03.00-04.04	M 112.947	6			<b>ZS 297</b>	
<b>SLK (R171)</b>									
200 Kompressor	1.8	120	03.04-11.06	M 271.944 Mot.Nr.→3085 3899	4			<b>ZS 053</b>	<b>GS 21</b>
200 Kompressor	1.8	120	11.06-02.11	M 271.944 Mot.Nr.3085 3900→	4			<b>ZS 077</b>	<b>GS 21</b>
200 Kompressor	1.8	135	01.08-02.11	M 271.954 Mot.Nr.3085 3900→	4			<b>ZS 077</b>	<b>GS 21</b>
280	3.0	170	01.05-02.11	M 272.942	6			<b>ZSE 140</b>	
300	3.0	170	04.09-02.11	M 272.942	6			<b>ZSE 140</b>	
350	3.5	200	06.04-02.11	M 272.963	6			<b>ZSE 140</b>	
350	3.5	224	01.08-02.11	M 272.969	6			<b>ZSE 140</b>	
55 AMG	5.4	265	06.04-02.11	M 113.989	8			<b>ZS 297</b>	
<b>SLK (R172)</b>									
200	1.8	135	02.11-	M 271.861	4			<b>ZS 077</b>	<b>GS 21</b>
250	1.8	150	02.11-	M 271.860/M 271.861	4			<b>ZS 077</b>	<b>GS 21</b>
<b>SLR (R199)</b>									
5.4	5.4	460	04.04-	M 155.980	8			<b>ZS 297</b>	
5.4 722 Edition	5.4	478	10.06-	M 155.980	8			<b>ZS 297</b>	
<b>SLR ROADSTER (R199)</b>									
5.4	5.4	460	04.07-	M 155.980	8			<b>ZS 297</b>	
5.4	5.4	478	10.06-	M 155.980	8			<b>ZS 297</b>	
<b>VANEO (414)</b>									
1.6	1.6	60	02.02-07.05	M 166.961	4			<b>ZSE 146</b>	
1.6	1.6	75	02.02-07.05	M 166.961	4			<b>ZSE 146</b>	
1.9	1.9	92	02.02-07.05	M 166.991	4			<b>ZSE 146</b>	
<b>V-KLASSE (638/2)</b>									
V 200	2.0	95	02.97-07.03	M 111.948/M 111.950	4			<b>ZS 340</b>	<b>ZLE 234</b>
V 230	2.3	105	10.96-07.03	M 111.978	4			<b>ZS 340</b>	<b>ZLE 234</b>
V 280	2.8	128	08.97-07.03	M 104.900	6			<b>ZSE 004</b>	
<b>VIANO (W639)</b>									
3,0	3.2	140	09.03-	M 112.951	6			<b>ZS 297</b>	
3,2	3.2	160	09.03-	M 112.951	6			<b>ZS 297</b>	
3,5	3.5	190	09.07-	M 272.979	6			<b>ZSE 140</b>	
3,7	3.7	170	06.04-	M 112.976	6			<b>ZS 297</b>	
<b>190 (W201)</b>									
2.0	2.0	66	10.82-10.84	M 102.921	4		<b>ZM 004</b>	<b>ZS 117</b>	
2.0	2.0	75	01.86-05.90	M 102.924	4		<b>ZM 004</b>	<b>ZS 117</b>	
2.0	2.0	75	01.86-05.90	M 102.924 KAT	4		<b>ZM 004</b>	<b>ZS 296</b>	
2.0	2.0	77	09.84-05.90	M 102.924	4		<b>ZM 004</b>	<b>ZS 117</b>	
2.0	2.0	77	09.84-05.90	M 102.924 KAT	4		<b>ZM 004</b>	<b>ZS 296</b>	
E 1.8	1.8	80	04.90-08.93	M 102.910	4			<b>ZS 296</b>	
E 2.0	2.0	83	02.85-12.86	M 102.961/M 102.962	4			<b>ZS 117</b>	
E 2.0	2.0	83	02.85-12.86	M 102.961/M 102.962	4			<b>ZS 296</b>	
E 2.0	2.0	85	02.85-12.86	M 102.962	4			<b>ZS 296</b>	





kW



**MERCEDES-BENZ**

<b>190 (W201)</b>							
E 2.0	2.0	87	01.85-08.93	M 102.962	4	ZM 004	ZS 117
E 2.0	2.0	87	01.85-08.93	M 102.962	4	ZM 004	ZS 296
E 2.0	2.0	90	10.82-06.93	M 102.962	4	ZM 004	ZS 117
E 2.0	2.0	90	10.82-06.93	M 102.961/M 102.962	4	ZM 004	ZS 296
E 2.3	2.3	97	09.86-08.91	M 102.985	4		ZS 296
E 2.3	2.3	100	10.86-08.93	M 102.985	4		ZS 117
E 2.3	2.3	100	10.86-08.93	M 102.985 KAT	4		ZS 296
E 2.3-16	2.3	125	09.85-12.87	M 102.983	4		ZS 339
E 2.3-16	2.3	130	09.85-08.88	M 102.983	4		ZS 339
E 2.3-16	2.3	136	04.84-01.87	M 102.983	4		ZS 339
E 2.5-16	2.5	143	03.89-08.93	M 102.991	4		ZS 339
E 2.5-16	2.5	150	09.88-08.93	M 102.990	4		ZS 339
E 2.6	2.6	118	09.86-08.93	M 103.942	6		ZS 117
E 2.6	2.6	118	09.86-08.93	M 103.942 KAT	6		ZS 296
E 2.6	2.6	122	09.86-12.89	M 103.942	6		ZS 117
E 2.6	2.6	122	09.86-12.89	M 103.942 KAT	6		ZS 296
E Evolution II 2.5	2.5	173	05.90-08.93	M 102.992	4		ZS 339
<b>COUPE (C123)</b>							
230 CE	2.3	100	04.80-12.85	M 102.980	4	ZM 004	ZS 117
280 CE	2.7	136	03.77-11.85	M 110.988	6	ZM 004	ZS 117
<b>KOMBI (S123)</b>							
200 T	2.0	74	11.80-07.84	M 102.939	4	ZM 004	
200 T	2.0	74	11.80-11.85	M 102.939	4		ZS 117
200 T	2.0	80	11.80-07.84	M 102.920	4	ZM 004	
200 T	2.0	80	11.80-11.85	M 102.920	4		ZS 117
230 TE	2.3	100	04.80-11.85	M 102.980	4	ZM 004	ZS 117
280 TE	2.7	136	09.77-11.85	M 110.988	6	ZM 004	ZS 117
<b>Stufenheck (W123)</b>							
200	2.0	74	06.80-11.85	M 102.939	4	ZM 004	ZS 117
200	2.0	80	06.80-11.85	M 102.920	4	ZM 004	ZS 117
230 E	2.3	100	04.80-12.85	M 102.980	4	ZM 004	ZS 117
250	2.5	103	09.82-07.85	M 123.921	6	ZM 004	ZS 117
280 E	2.7	136	09.81-11.85	M 110.988/M 110.984	6	ZM 004	
280 E	2.7	136	04.80-11.85	M 110.988/M 110.984	6		ZS 117
280 E	2.7	136	02.76-11.85	M 110.988/M 110.984	6		ZS 400
<b>COUPE (C124)</b>							
220 CE	2.2	110	10.92-05.93	M 111.960	4		ZS 313
230 CE	2.3	97	03.87-12.92	M 102.982	4	ZM 004	ZS 117
230 CE	2.3	97	03.87-12.92	M 102.982 KAT	4	ZM 004	ZS 339
230 CE	2.3	100	03.87-12.92	M 102.982	4	ZM 004	ZS 117
230 CE	2.3	100	03.87-12.92	M 102.982 KAT	4	ZM 004	ZS 339
230 CE KAT	2.3	97	06.89-12.92	M 102.982	4	ZM 004	
230 CE KAT	2.3	97	06.89-12.92	M 102.982	4	ZM 004	ZS 117
230 CE KAT	2.3	97	06.89-12.92	M 102.982 KAT	4	ZM 004	ZS 339
300 CE	3.0	132	03.87-05.93	M 103.983	6		ZS 296
300 CE	3.0	138	03.87-12.89	M 103.983	6		ZS 296
300 CE-24	3.0	162	09.89-12.92	M 104.980	6		ZS 298
300 CE-24	3.0	170	09.89-12.92	M 104.980	6		ZS 298
320 CE	3.2	162	10.92-05.93	M 104.992	6		ZS 340 ZLE 234
<b>KOMBI (S124)</b>							
200 T	2.0	77	01.86-05.90	M 102.922	4	ZM 004	
200 T	2.0	77	01.86-05.90	M 102.922	4		ZS 117
200 T	2.0	77	01.86-05.90	M 102.922 KAT	4		ZS 339
200 T	2.0	80	09.85-08.89	M 102.922	4	ZM 004	
200 T	2.0	80	09.85-08.89	M 102.922	4		ZS 117



kW



**MERCEDES-BENZ**

**KOMBI (S124)**

200 T	2.0	80	09.85-08.89	M 102.922 KAT	4		<b>ZS 339</b>		
200 TE	2.0	87	09.88-08.92	M 102.963	4	<b>ZM 004</b>	<b>ZS 117</b>		
200 TE	2.0	87	09.88-08.92	M 102.963 KAT	4		<b>ZS 339</b>		
200 TE	2.0	90	09.88-12.89	M 102.962	4	<b>ZM 004</b>			
200 TE	2.0	90	09.88-12.89	M 102.962	4		<b>ZS 117</b>		
200 TE	2.0	90	09.88-12.89	M 102.962 KAT	4		<b>ZS 339</b>		
200 TE	2.0	100	10.92-06.93	M 111.940	4		<b>ZS 313</b>		
220 TE	2.2	110	10.92-05.93	M 111.960	4		<b>ZS 313</b>		
230 TE	2.3	97	09.85-08.92	M 102.982	4	<b>ZM 004</b>	<b>ZS 117</b>		
230 TE	2.3	97	09.85-08.92	M 102.982	4		<b>ZS 339</b>		
230 TE	2.3	100	09.85-08.92	M 102.982	4	<b>ZM 004</b>	<b>ZS 117</b>		
230 TE	2.3	100	09.85-08.92	M 102.982 KAT	4		<b>ZS 339</b>		
230 TE KAT	2.3	97	06.89-08.92	M 102.982	4	<b>ZM 004</b>	<b>ZS 117</b>		
230 TE KAT	2.3	97	06.89-08.92	M 102.982 KAT	4		<b>ZS 339</b>		
260 TE FGST.	2.6	118	09.89-08.92	M 103.940	6		<b>ZS 296</b>		
260 TE FGST.	2.6	122	09.85-12.89	M 103.940	6		<b>ZS 296</b>		
280 TE	2.8	145	10.92-06.93	M 104.942	6		<b>ZS 340</b>	<b>ZLE 234</b>	
300 TE	3.0	132	01.86-08.92	M 103.983	6		<b>ZS 296</b>		
300 TE	3.0	138	01.86-12.89	M 103.983	6		<b>ZS 296</b>		
300 TE 4-matic	3.0	132	09.86-06.93	M 103.985	6		<b>ZS 296</b>		
300 TE 4-matic	3.0	138	09.86-12.89	M 103.983	6		<b>ZS 296</b>		
300 TE-24	3.0	162	09.89-08.92	M 104.980	6		<b>ZS 298</b>		
320 TE	3.2	162	10.92-06.93	M 104.992	6		<b>ZS 340</b>	<b>ZLE 234</b>	
<b>Stufenheck (W124)</b>									
200	2.0	75	01.86-05.90	M 102.922	4	<b>ZM 004</b>	<b>ZS 117</b>		
200	2.0	75	01.86-05.90	M 102.922 KAT	4		<b>ZS 339</b>		
200	2.0	77	01.86-05.90	M 102.922	4	<b>ZM 004</b>	<b>ZS 117</b>		
200	2.0	77	01.86-05.90	M 102.922 KAT	4		<b>ZS 339</b>		
200	2.0	80	12.85-05.90	M 102.922	4	<b>ZM 004</b>	<b>ZS 117</b>		
200	2.0	80	12.85-05.90	M 102.922 KAT	4		<b>ZS 339</b>		
200 E	2.0	87	09.88-08.92	M 102.963	4	<b>ZM 004</b>	<b>ZS 117</b>		
200 E	2.0	87	09.88-08.92	M 102.963 KAT	4		<b>ZS 339</b>		
200 E	2.0	90	09.88-12.89	M 102.963	4	<b>ZM 004</b>	<b>ZS 117</b>		
200 E	2.0	90	09.88-12.89	M 102.963 KAT	4		<b>ZS 339</b>		
200 E	2.0	100	10.92-06.93	M 111.940	4		<b>ZS 313</b>		
220 E	2.2	110	10.92-06.93	M 111.960	4		<b>ZS 313</b>		
230 E	2.3	97	12.84-03.92	M 102.982	4	<b>ZM 004</b>	<b>ZS 117</b>		
230 E	2.3	97	12.84-03.92	M 102.982 KAT	4		<b>ZS 339</b>		
230 E	2.3	100	01.85-06.93	M 102.982	4	<b>ZM 004</b>	<b>ZS 117</b>		
230 E	2.3	100	01.85-06.93	M 102.982 KAT	4		<b>ZS 339</b>		
230 E KAT	2.3	97	06.89-06.93	M 102.982	4	<b>ZM 004</b>	<b>ZS 117</b>		
230 E KAT	2.3	97	06.89-06.93	M 102.982 KAT	4		<b>ZS 339</b>		
260 E	2.6	118	09.85-08.92	M 103.940	6		<b>ZS 339</b>		
260 E	2.6	118	09.85-08.92	M 103.940	6		<b>ZS 296</b>		
260 E	2.6	122	09.85-12.89	M 103.940	6		<b>ZS 296</b>		
260 E	2.6	122	09.85-12.89	M 103.940 Fgst.Nr.A 511 984→	6		<b>ZS 339</b>		
260 E 4-matic	2.6	118	09.86-08.92	M 103.943	6		<b>ZS 296</b>		
260 E 4-matic	2.6	122	12.86-12.89	M 103.940	6		<b>ZS 296</b>		
280 E	2.8	145	10.92-06.93	M 104.942	6		<b>ZS 340</b>	<b>ZLE 234</b>	



kW



**MERCEDES-BENZ**

**Stufenheck (W124)**

300 E	3.0	132	08.85-08.92	M 103.983	6	<b>ZS 296</b>	
300 E	3.0	138	01.85-12.85	M 103.980	6	<b>ZS 296</b>	
300 E	3.0	138	06.85-08.92	M 103.983	6	<b>ZS 296</b>	
300 E 4-matic	3.0	132	09.86-06.93	M 103.985	6	<b>ZS 296</b>	
300 E 4-matic	3.0	138	09.86-02.92	M 103.983	6	<b>ZS 296</b>	
300 E-24	3.0	162	09.88-08.92	M 104.980	6	<b>ZS 298</b>	
320 E	3.2	162	10.92-06.93	M 104.992	6	<b>ZS 340</b>	<b>ZLE 234</b>
400 E 4.2	4.2	205	10.92-06.93	M 119.975	8	<b>ZS 298</b> <sup>290</sup>	
400 E 4.2	4.2	205	10.92-06.93	M 119.975	8	<b>ZS 299</b> <sup>289</sup>	
500 E	5.0	240	01.91-06.93	M 119.974 Fgst.Nr.→B 568955	8	<b>ZS 339</b> <sup>289</sup>	
500 E	5.0	240	01.91-06.93	M 119.974 Fgst.Nr.→B 568955	8	<b>ZS 296</b> <sup>290</sup>	
500 E	5.0	240	01.91-06.93	M 119.974 Fgst.Nr.B 568956→	8	<b>ZS 299</b> <sup>289</sup>	
500 E	5.0	240	01.91-06.93	M 119.974 Fgst.Nr.B 568956→	8	<b>ZS 298</b> <sup>290</sup>	
500 E AMG 6.0	6.0	275	01.92-06.93	Fgst.Nr.→B 568955	8	<b>ZS 339</b> <sup>289</sup>	
500 E AMG 6.0	6.0	275	01.92-06.93	Fgst.Nr.→B 568955	8	<b>ZS 296</b> <sup>290</sup>	
500 E AMG 6.0	6.0	275	01.92-06.93	Fgst.Nr.B 568956→	8	<b>ZS 299</b> <sup>289</sup>	
500 E AMG 6.0	6.0	275	01.92-06.93	Fgst.Nr.B 568956→	8	<b>ZS 298</b> <sup>290</sup>	



**SPRINTER (901, 902)**

214	2.3	105	02.95-05.06	M 111.979/M 111.984	4	<b>ZS 340</b>	<b>ZLE 234</b>
214 NGT	2.3	92	04.00-05.06	M 111.984	4	<b>ZS 340</b>	<b>ZLE 234</b>

**SPRINTER (903)**

314	2.3	105	02.95-05.06	M 111.984	4	<b>ZS 340</b>	<b>ZLE 234</b>
314 4x4	2.3	105	08.02-05.06	M 111.984	4	<b>ZS 340</b>	<b>ZLE 234</b>
314 NGT	2.3	92	04.00-05.06	M 111.984	4	<b>ZS 340</b>	<b>ZLE 234</b>

**SPRINTER (904)**

414	2.3	105	02.96-05.06	M 111.979	4	<b>ZS 340</b>	<b>ZLE 234</b>
414 4x4	2.3	105	05.97-05.06	M 111.979	4	<b>ZS 340</b>	<b>ZLE 234</b>

**SPRINTER (906)**

316	1.8	115	09.08-10.10	M 271.951 Mot.Nr.→30853899	4	<b>ZS 053</b>	<b>GS 21</b>
316	1.8	115	11.10-	M 271.951 Mot.Nr.3085 3900→	4	<b>ZS 077</b>	<b>GS 21</b>
316 NGT	1.8	115	09.08-10.10	M 271.951 Mot.Nr.→30853899	4	<b>ZS 053</b>	<b>GS 21</b>
316 NGT	1.8	115	11.10-	M 271.951 Mot.Nr.3085 3900→	4	<b>ZS 077</b>	<b>GS 21</b>
324	3.5	190	06.06-	M 272.979	6	<b>ZSE 140</b>	

**T1 (601)**

210 2.3	2.3	70	07.82-01.90	M 102.942	4	<b>ZM 004</b>	<b>ZS 117</b>
210 2.3	2.3	77	05.89-06.95	M 102.945	4	<b>ZM 004</b>	<b>ZS 117</b>

**T1/TN**

410	2.3	70	08.82-06.95	M 102.942	4	<b>ZM 004</b>	<b>ZS 117</b>
410	2.3	77	08.82-06.95	M 102.945	4	<b>ZM 004</b>	<b>ZS 117</b>

**T2/L**

L 410	2.3	70	08.82-12.88	M 102.943	4	<b>ZM 040</b>	
L 410	2.3	70	08.82-12.88	M 102.943	4		<b>ZS 106</b>
L 410	2.3	70	08.82-12.88	M 102.943	4		<b>ZS 117</b>

**T2/LN1**

510	2.3	70	04.86-12.94	M 102.946	4	<b>ZM 004</b>	<b>ZS 117</b>
510	2.3	77	04.86-12.94	M 102.946	4	<b>ZM 004</b>	<b>ZS 117</b>

**VITO (638)**

113 2.0	2.0	95	02.96-07.03	M 111.948/M 111.950	4	<b>ZS 340</b>	<b>ZLE 234</b>
114 2.3	2.3	105	12.96-07.03	M 111.978	4	<b>ZS 340</b>	<b>ZLE 234</b>



kW

**MERCEDES-BENZ**

**VITO (W639)**

119	3.2	140	09.03–	M 112.951	6	<b>ZS 297</b>
122	3.2	160	09.03–	M 112.951	6	<b>ZS 297</b>
123	3.7	170	06.04–	M 112.976	6	<b>ZS 297</b>
126	3.5	190	09.07–	M 272.978	6	<b>ZSE 140</b>

**MG**
**MG ZR**

105	1.4	76	06.01–04.05	14 K4F Fgst.Nr.471656→	4	<b>ZS 501</b>
-----	-----	----	-------------	---------------------------	---	---------------

**MG ZT**

160	2.5	118	06.01–07.05	25 K4F	6	<b>ZS 088</b>
180	2.5	130	01.03–07.05	25 K4F	6	<b>ZS 088</b>
190	2.5	140	06.01–07.05	25 K4F	6	<b>ZS 088</b>

**MG ZT- T**

160	2.5	118	10.01–07.05	KV 6	6	<b>ZS 088</b>
180	2.5	130	01.03–07.05	25 K4F	6	<b>ZS 088</b>
190	2.5	140	10.01–07.05	25 K4F	6	<b>ZS 088</b>

**MGF**

1.8 i VVC	1.8	107	03.95–03.02	18 K4K	4	<b>ZS 502</b>
1.8 i 16V	1.8	88	03.95–03.02	18 K4F CVT-Automatik	4	<b>ZS 501</b>

**MINI**
**MINI (R50, R53)**

1.4	1.4	55	04.03–09.06		4	<b>ZS 382</b>
Cooper S	1.6	120	03.02–09.06	W11B16A	4	<b>ZS 382</b>
Cooper S	1.6	125	07.04–09.06	W11B16A	4	<b>ZS 382</b>
One	1.6	66	06.01–09.06	W10B16A	4	<b>ZS 382</b>
S Works	1.6	147	11.03–06.05	W11B16A	4	<b>ZS 382</b>
Works	1.6	155	11.03–09.06	W11B16A	4	<b>ZS 382</b>

**MINI (R56)**

Cooper	1.6	85	03.10–	N16 B16 A	4	<b>ZSE 143</b>
Cooper	1.6	88	10.06–08.10	N12B16A	4	<b>ZSE 143</b>
Cooper	1.6	90	03.10–	N16 B16 A	4	<b>ZSE 143</b>
One	1.4	55	03.09–02.10	N12B14A	4	<b>ZSE 143</b>
One	1.4	70	03.07–02.10	N12B14A	4	<b>ZSE 143</b>
One	1.6	55	03.10–	N16 B16 A	4	<b>ZSE 143</b>
One	1.6	72	03.10–	N16 B16 A	4	<b>ZSE 143</b>

**MINI Cabriolet (R52)**

Cooper	1.6	85	07.04–11.07	W10B16A	4	<b>ZS 382</b>
Cooper S	1.6	125	07.04–11.07	W11B16A	4	<b>ZS 382</b>
John Cooper Works	1.6	155	07.04–11.07	W11B16A	4	<b>ZS 382</b>
One	1.6	66	07.04–11.07	W10B16A	4	<b>ZS 382</b>

**MINI Cabriolet (R57)**

Cooper	1.6	88	03.09–06.10	N12B16A	4	<b>ZSE 143</b>
Cooper	1.6	90	03.10–	N16 B16 A	4	<b>ZSE 143</b>
One	1.6	72	03.10–	N16 B16 A	4	<b>ZSE 143</b>

**MINI CLUBMAN (R55)**

Cooper	1.6	85	03.10–	N16 B16 A	4	<b>ZSE 143</b>
Cooper	1.6	88	10.07–07.10	N12B16A/N16 B16 A	4	<b>ZSE 143</b>
Cooper	1.6	90	03.10–	N16 B16 A	4	<b>ZSE 143</b>
One	1.4	70	03.09–02.10	N12B14A	4	<b>ZSE 143</b>
One	1.6	72	03.10–	N16 B16 A	4	<b>ZSE 143</b>

**MINI COUNTRYMAN (R60)**

Cooper	1.6	85	06.10–	N16 B16 A	4	<b>ZSE 143</b>
Cooper	1.6	90	09.10–	N16 B16 A	4	<b>ZSE 143</b>
One	1.6	72	06.10–	N16 B16 A	4	<b>ZSE 143</b>

**MINI Coupe (R58)**

Cooper	1.6	85	09.11–	N16 B16 A	4	<b>ZSE 143</b>
--------	-----	----	--------	-----------	---	----------------



kW

**MINI****MINI Coupe (R58)**

Cooper	1.6	90	09.11–	N16 B16 A	4		<b>ZSE 143</b>
--------	-----	----	--------	-----------	---	--	----------------

**MINI Roadster (R59)**

Cooper	1.6	85	02.12–	N16 B16 A	4		<b>ZSE 143</b>
Cooper	1.6	90	02.12–	N16 B16 A	4		<b>ZSE 143</b>

**MITSUBISHI****COLT II**

1.2 EL, GL	1.2	40	02.84–09.86	4G16	4		<b>ZS 106</b>
1.2 EL, GL	1.2	40	02.84–09.86	4G16	4		<b>ZS 115</b>
1.2 EL, GL	1.2	44	09.86–04.88	4G16	4		<b>ZS 106</b>
1.2 EL, GL	1.2	44	09.86–04.88	4G16	4		<b>ZS 115</b>
1.5 GLX	1.5	51	09.85–04.88	G15B	4		<b>ZS 106</b>
1.5 GLX	1.5	51	09.85–04.88	G15B	4		<b>ZS 115</b>
1.5 GLX	1.5	55	09.84–04.88	4G15	4		<b>ZS 106</b>
1.5 GLX	1.5	55	09.84–04.88	4G15	4		<b>ZS 115</b>
1.6 Turbo ECi	1.6	92	02.84–04.88	4G32 T/C	4		<b>ZS 106</b>
1.6 Turbo ECi	1.6	92	02.84–04.88	4G32 T/C	4		<b>ZS 115</b>

**COLT III**

1.3	1.3	51	01.89–05.92	4G13 (8V)	4	<b>ZM 049</b>	
1.3 12V	1.3	55	04.88–05.92	4G13 (12V)	4	<b>ZM 049</b>	<b>ZS 263</b>
1.3 GL	1.3	44	04.88–12.90	4G13 (8V)	4	<b>ZM 049</b>	<b>ZS 263</b>
1.5 GLXi	1.5	62	01.89–05.92	4G15	4	<b>ZM 049</b>	
1.5 GLXi	1.5	62	04.88–05.92	4G15	4		<b>ZS 263</b>
1.5 KAT	1.5	66	07.90–05.92	4G15 (12V)	4	<b>ZM 049</b>	<b>ZS 106</b>
1.5 KAT	1.5	66	07.90–05.92	4G15 (12V)	4	<b>ZM 049</b>	<b>ZS 115</b>
1.6 GTi 16V	1.6	91	01.89–05.90	4G61	4	<b>ZM 049</b>	
1.8 GTi 16V KAT	1.8	100	06.90–05.92	4G67	4	<b>ZM 049</b>	

**COLT IV**

1.3 GLi 12V	1.3	55	04.92–04.96	4G13 (12V)	4	<b>ZM 049</b>	
1.6	1.6	66	02.94–04.96	4G92	4	<b>ZM 049</b>	
1.6 GLXi 16V	1.6	83	04.92–04.96	4G92	4	<b>ZM 049</b>	
1.8 GTi 16V	1.8	103	04.92–04.96	4G93	4	<b>ZM 049</b>	

**COLT V**

1300 GL, GLX	1.3	55	05.96–09.00	4G13 (12V)	4	<b>ZM 049</b>	<b>ZS 264</b>
1600 GLX	1.6	66	05.96–09.00	4G92	4	<b>ZM 049</b>	

**CORDIA**

1.6 GSL	1.6	55	01.83–12.86	4G32	4	<b>ZM 053</b>	
1.6 GSL	1.6	55	10.82–12.86	4G32	4		<b>ZS 106</b>
1.6 GSL	1.6	55	10.82–12.86	4G32	4		<b>ZS 115</b>
1.6 Turbo	1.6	84	01.83–05.85	4G32 T	4	<b>ZM 053</b>	
1.6 Turbo	1.6	84	10.82–05.85	4G32 T	4		<b>ZS 106</b>
1.6 Turbo	1.6	84	10.82–05.85	4G32 T	4		<b>ZS 115</b>
1.6 Turbo	1.6	85	07.83–05.85	4G32 T	4	<b>ZM 053</b>	<b>ZS 106</b>
1.6 Turbo	1.6	85	07.83–05.85	4G32 T	4	<b>ZM 053</b>	<b>ZS 115</b>
1.8 GSL	1.8	66	10.86–12.86	4G37	4		<b>ZS 106</b>
1.8 GSL	1.8	66	10.86–12.86	4G37	4		<b>ZS 115</b>
1.8 Turbo ECi	1.8	100	10.84–12.86	4G62 T	4		<b>ZS 106</b>
1.8 Turbo ECi	1.8	100	10.84–12.86	4G62 T	4		<b>ZS 115</b>

**GALANT III**

1.6 GLX	1.6	55	06.84–04.90	4G32	4		<b>ZS 106</b>
1.6 GLX	1.6	55	06.84–04.90	4G32	4		<b>ZS 110</b>
1.6 GLX	1.6	55	06.84–04.90	4G32	4		<b>ZS 115</b>
2.0 GLS	2.0	66	06.86–04.90	G63B	4		<b>ZS 106</b>
2.0 GLS	2.0	66	06.86–04.90	G63B	4		<b>ZS 110</b>
2.0 GLS	2.0	66	06.86–04.90	G63B	4		<b>ZS 115</b>
2.0 GLS	2.0	75	06.84–04.90	4G63 (SOHC 8V)	4		<b>ZS 106</b>
2.0 GLS	2.0	75	06.84–04.90	4G63 (SOHC 8V)	4		<b>ZS 115</b>
2.0 Turbo ECi	2.0	110	06.84–04.90	4G63 T (SOHC 8V)	4	<b>ZM 022</b>	<b>ZS 263</b>
2.4 GLS	2.4	82	07.85–04.90	G64B	4		<b>ZS 106</b>
2.4 GLS	2.4	82	07.85–04.90	G64B	4		<b>ZS 115</b>



kW

**MITSUBISHI**

<b>MITSUBISHI</b>								
<b>GALANT IV</b>								
1.8	1.8	66	11.88–10.92	4G37	4	<b>ZM 049</b>	<b>ZS 106</b>	
1.8	1.8	66	11.88–10.92	4G37	4	<b>ZM 049</b>	<b>ZS 115</b>	
2.0	2.0	80	04.89–10.92	4G63 (SOHC 8V)	4	<b>ZM 049</b>	<b>ZS 261</b> <sup>202</sup>	
2.0	2.0	80	04.89–10.92	4G63 (SOHC 8V)	4	<b>ZM 049</b>	<b>ZS 263</b> <sup>202</sup>	
2.0 4x4	2.0	80	04.89–10.92	4G63 (SOHC 8V)	4			
2.0 4x4	2.0	80	04.89–10.92	4G63 (SOHC 8V)	4	<b>ZM 049</b>	<b>ZS 261</b> <sup>202</sup>	
2.0 4x4	2.0	80	04.89–10.92	4G63 (SOHC 8V)	4	<b>ZM 049</b>	<b>ZS 263</b> <sup>202</sup>	
2.0 GTI 16V	2.0	106	01.89–10.92	4G63 (DOHC 16V)	4	<b>ZM 049</b>		
2.0 GTI 16V	2.0	107	01.89–10.92	4G63 (DOHC 16V)	4	<b>ZM 049</b>		
2.0 GTI 16V 4x4	2.0	106	07.89–12.92	4G63 (DOHC 16V)	4	<b>ZM 049</b>		
<b>GALANT V</b>								
1.8	1.8	85	02.94–08.96	4G93	4	<b>ZM 049</b>		
1.8 GLSI	1.8	93	11.92–08.96	4G93 (GDI)	4	<b>ZM 049</b>		
2.0 GLSI	2.0	101	11.92–08.96	4G63 (SOHC 8V)	4	<b>ZM 049</b>		
2.0 GLSI 4x4	2.0	101	11.92–08.96	4G63 (SOHC 8V)	4	<b>ZM 049</b>		
2.0 V6-24	2.0	110	11.92–08.96	6A12	6	<b>ZM 049</b>		
2.5 V6-24 4x4	2.5	125	11.92–08.96	6G73	6	<b>ZM 049</b>		
<b>GALANT VI</b>								
2.0	2.0	100	09.96–09.00	4G63 (SOHC 16V)	4	<b>ZM 049</b>		
2.4 GDI	2.4	110	02.99–09.00	4G64 (GDI)	4	<b>ZM 049</b>		
2.5 V6 24V	2.5	120	09.96–09.00	6A13	6	<b>ZM 049</b>		
<b>GALLOPER</b>								
3.0 V6	3.0	104	09.98–12.03	6G6AT	6		<b>ZSE 010</b>	
<b>LANCER III</b>								
1.5	1.5	51	01.89–08.89	G15B	4	<b>ZM 049</b>		
1.5	1.5	55	09.85–12.87	4G15	4		<b>ZS 263</b>	
1.5	1.5	61	01.89–12.90	4G15	4	<b>ZM 049</b>		
1.5	1.5	61	09.88–12.90	4G15	4		<b>ZS 263</b>	
1.5 12V	1.5	66	09.90–12.91	4G15 (12V)	4	<b>ZM 051</b>		
1.8 4x4	1.8	61	01.89–08.89	G37B	4	<b>ZM 049</b>		
1.8 4x4	1.8	63	03.89–12.90	4G37	4	<b>ZM 049</b>		
1.8 4x4	1.8	69	08.90–06.92	4G37	4	<b>ZM 049</b>		
<b>LANCER IV</b>								
1.3 12V	1.3	55	06.92–05.94	4G13 (12V)	4	<b>ZM 049</b>		
1.5 12V	1.5	66	05.89–05.90	4G15 (12V)	4		<b>ZS 263</b>	
1.5 12V	1.5	66	01.90–05.92	4G15 (12V)	4	<b>ZM 051</b>		
1.6 16V	1.6	83	06.92–05.94	4G92	4	<b>ZM 049</b>		
1.8 4x4	1.8	71	01.90–06.92	4G37	4	<b>ZM 051</b>		
1.8 4x4	1.8	71	09.89–06.92	4G37	4		<b>ZS 263</b>	
1.8 GTi 16V	1.8	100	01.90–05.92	4G67	4	<b>ZM 051</b>		
1.8 GTi 16V	1.8	103	06.92–12.93	4G93	4	<b>ZM 049</b>		
<b>LANCER V</b>								
1.3	1.3	55	06.92–12.96	4G13 (12V)	4	<b>ZM 049</b>		
1.6	1.6	66	02.94–12.96	4G92	4	<b>ZM 049</b>		
1.6 16V	1.6	83	06.92–12.96	4G92	4	<b>ZM 049</b>		
1.6 16V 4WD	1.6	83	06.92–12.96	4G92	4	<b>ZM 049</b>		
<b>LANCER VI</b>								
1.3 12V	1.3	55	12.95–08.03	4G13 (12V)	4	<b>ZM 049</b>		
1.5 16V	1.5	69	12.95–08.03	4G15 (16V)	4	<b>ZM 049</b>		
1.6 16V	1.6	66	12.95–08.03	4G92	4	<b>ZM 049</b>		
2.0 16V EVO	2.0	206	08.96–08.03	4G63 Turbo	4	<b>ZM 049</b>		
<b>PAJERO I</b>								
2.6	2.6	76	01.83–11.90	4G54	4		<b>ZS 282</b>	
3.0 V6	3.0	104	11.88–11.90	6G72 (SOHC 12V)	6	<b>ZM 049</b>	<b>ZS 282</b>	
<b>PAJERO II</b>								
2.4	2.4	82	04.91–10.99	4G64 (12V)	4		<b>ZS 263</b>	
3.0 V6 4x4	3.0	110	12.90–12.95	6G72 (SOHC 12V)	6		<b>ZS 282</b>	
<b>SANTAMO</b>								
2.0 16V	2.0	102	05.99–12.04	4G63 (DOHC 16V)	4		<b>ZS 521</b>	
<b>SAPORO II</b>								
2.0 GSR	2.0	82	08.80–09.84	4G63 (SOHC 8V)	4	<b>ZM 022</b>	<b>ZS 106</b>	



kW



**MITSUBISHI**

<b>SAPORO II</b>							
2.0 GSR	2.0	82	08.80–09.84	4G63 (SOHC 8V)	4	<b>ZM 022</b>	<b>ZS 115</b>
<b>SAPORO III</b>							
2.4	2.4	91	06.87–08.90	4G64 (8V)	4		<b>ZS 261</b>
<b>SIGMA</b>							
3.0 V6	3.0	130	12.90–07.96	6G72 (SOHC 12V)	6		<b>ZS 511</b>
<b>STARION</b>							
2.0 Turbo ECI	2.0	125	06.82–12.85	4G63 T (ECI)	4	<b>ZM 022</b>	

**NISSAN**

<b>100 NX</b>							
1.6	1.6	66	03.90–10.94	GA16DS	4	<b>ZM 048</b>	<b>ZS 277</b>
1.6 SR	1.6	75	09.93–10.94	GA16DE	4		<b>ZS 277</b>
2.0 GTI	2.0	105	03.91–10.94	SR20DE	4	<b>ZM 048</b>	<b>ZS 277</b>
<b>350 Z</b>							
3.5	3.5	206	10.03–01.07	VQ35DE	6		<b>ZSE 132</b>
3.5	3.5	221	04.06–01.07	VQ35DE	6		<b>ZSE 132</b>
<b>350 Z Roadster</b>							
3.5	3.5	206	03.05–01.07	VQ35DE	6		<b>ZSE 132</b>
3.5	3.5	221	04.06–01.07	VQ35DE	6		<b>ZSE 132</b>
<b>ALMERA I</b>							
1.4 GX,LX	1.4	55	09.95–07.00	GA14DE	4		<b>ZS 277</b>
1.6 SLX	1.6	66	09.95–07.00	GA16DE	4		<b>ZS 277</b>
<b>ALMERA II</b>							
1.5	1.5	66	07.00–03.01	QG15DE	4		<b>ZSE 021</b>
1.5	1.5	66	04.01–07.02	QG15DE	4		<b>ZSE 081</b>
1.5	1.5	72	10.02–	QG15DE	4		<b>ZSE 021</b>
1.8	1.8	84	07.00–03.01	QG18DE	4		<b>ZSE 021</b>
1.8	1.8	84	04.01–07.02	QG18DE	4		<b>ZSE 081</b>
1.8	1.8	85	10.02–11.06	QG18DE	4		<b>ZSE 081</b>
<b>ALMERA TINO</b>							
1.8	1.8	84	08.00–12.00	QG18DE	4		<b>ZSE 021</b>
1.8	1.8	84	01.01–12.05	QG18DE	4		<b>ZSE 081</b>
1.8	1.8	85	12.02–	QG18DE	4		<b>ZSE 021</b>
1.8	1.8	85	12.02–	QG18DE	4		<b>ZSE 081</b>
<b>ARMADA</b>							
5.6	5.6	227	08.03–	VK56DE	8		<b>ZSE 134<sup>202</sup></b>
5.6 4x4	5.6	233	01.12–	VK56DE	8		<b>ZSE 134<sup>202</sup></b>
<b>BLUEBIRD</b>							
2.0 i	2.0	77	04.84–01.88	CA20E	4		<b>ZS 106</b>
2.0 i	2.0	77	04.84–01.88	CA20E	4		<b>ZS 115</b>
<b>CEFIRO</b>							
2.0	2.0	103	10.94–12.99	VQ20DE	6		<b>ZSE 071</b>
2.0	2.0	103	10.94–12.99	VQ20DE	6		<b>ZSE 073</b>
<b>CHERRY III</b>							
1.3	1.3	44	05.82–10.86	E13	4		<b>ZS 106</b>
1.3	1.3	44	05.82–10.86	E13	4		<b>ZS 115</b>
1.5	1.5	55	11.83–10.86	E15S	4		<b>ZS 106</b>
1.5	1.5	55	11.83–10.86	E15S	4		<b>ZS 115</b>
<b>CIMA</b>							
4.1	4.1	198	07.96–02.01	VH41DE	8		<b>ZSE 074</b>
4.1	4.1	198	09.91–06.96	VH41DE	8		<b>ZSE 074</b>
<b>CUBE</b>							
1.6 16V	1.6	81	03.10–	HR16DE	4		<b>ZSE 056</b>
<b>LATIO</b>							
1.5	1.5	80	11.04–	HR15DE	4		<b>ZSE 088</b>
<b>LAUREL</b>							
2.4	2.4	88	09.83–12.85	L24	6		<b>ZS 109</b>
<b>MAXIMA II</b>							
3.0 i	3.0	125	10.88–06.94	VG30E	6	<b>ZM 048</b>	<b>ZS 277</b>
<b>MAXIMA QX II</b>							
2.0 V6 24V	2.0	103	03.00–11.03	VQ20DE	6		<b>ZSE 071<sup>202</sup></b>



kW

**NISSAN****MAXIMA QX II**

2.0 V6 24V	2.0	103	03.00–11.03	VQ20DE	6	ZSE 073 <sup>202</sup>
2.0 V6 24V	2.0	103	03.00–11.03	VQ20DE	6	ZSE 075 <sup>202</sup>
2.0 V6 24V	2.0	103	03.00–11.03	VQ20DE	6	ZSE 077 <sup>202</sup>
2.0 V6 24V	2.0	103	03.00–11.03	VQ20DE	6	ZSE 078 <sup>202</sup>
2.0 V6 24V	2.0	103	03.00–11.03	VQ20DE	6	ZSE 082
3.0 V6 24V	3.0	147	03.00–11.03	VQ30DE	6	ZSE 071 <sup>202</sup>
3.0 V6 24V	3.0	147	03.00–11.03	VQ30DE	6	ZSE 073 <sup>202</sup>
3.0 V6 24V	3.0	147	03.00–11.03	VQ30DE	6	ZSE 075 <sup>202</sup>
3.0 V6 24V	3.0	147	03.00–11.03	VQ30DE	6	ZSE 077 <sup>202</sup>
3.0 V6 24V	3.0	147	03.00–11.03	VQ30DE	6	ZSE 078 <sup>202</sup>
3.0 V6 24V	3.0	147	03.00–11.03	VQ30DE	6	ZSE 082

**MAXIMA QX III**

2.0	2.0	103	02.95–08.00	VQ20DE	6	ZSE 071 <sup>202</sup>
2.0	2.0	103	02.95–08.00	VQ20DE	6	ZSE 073 <sup>202</sup>
2.0	2.0	103	02.95–08.00	VQ20DE	6	ZSE 075 <sup>202</sup>
2.0	2.0	103	02.95–08.00	VQ20DE	6	ZSE 078 <sup>202</sup>
3.0	3.0	142	01.95–08.00	VQ30DE	6	ZSE 071
3.0	3.0	142	01.95–08.00	VQ30DE	6	ZSE 073 <sup>202</sup>
3.0	3.0	142	01.95–08.00	VQ30DE	6	ZSE 075 <sup>202</sup>
3.0	3.0	142	01.95–08.00	VQ30DE	6	ZSE 078 <sup>202</sup>

**MAXIMA Station Wagon**

2.0 QX	2.0	103	10.97–	VQ20DE	6	ZSE 071 <sup>202</sup>
2.0 QX	2.0	103	10.97–	VQ20DE	6	ZSE 073 <sup>202</sup>
2.0 QX	2.0	103	10.97–	VQ20DE	6	ZSE 075 <sup>202</sup>
2.0 QX	2.0	103	10.97–	VQ20DE	6	ZSE 077 <sup>202</sup>
2.0 QX	2.0	103	10.97–	VQ20DE	6	ZSE 078 <sup>202</sup>
3.0 QX	3.0	142	10.97–	VQ30DE	6	ZSE 071 <sup>202</sup>
3.0 QX	3.0	142	10.97–	VQ30DE	6	ZSE 073 <sup>202</sup>
3.0 QX	3.0	142	10.97–	VQ30DE	6	ZSE 075 <sup>202</sup>
3.0 QX	3.0	142	10.97–	VQ30DE	6	ZSE 077 <sup>202</sup>
3.0 QX	3.0	142	10.97–	VQ30DE	6	ZSE 078 <sup>202</sup>

**MICRA C+C**

1.6 160 SR	1.6	81	08.05–	HR16DE	4	ZSE 056
------------	-----	----	--------	--------	---	---------

**MICRA I**

1.0	1.0	37	12.82–11.88	MA10S	4	ZS 109
1.0	1.0	40	12.82–11.88	MA10S	4	ZS 109
1.2	1.2	40	07.86–07.92	MA12S	4	ZS 277

**MICRA II**

1.0 i 16V	1.0	40	07.00–09.00	CG10DE	4	ZS 337
1.0 i 16V	1.0	44	09.00–10.02	CG10DE	4	ZS 337
1.3 i 16V	1.3	55	08.92–09.00	CG13DE	4	ZS 337
1.4 i 16V	1.3	60	09.00–10.02	CGA3DE	4	ZS 337

**MICRA III**

160 SR	1.6	81	05.05–06.10	HR16DE	4	ZSE 056
--------	-----	----	-------------	--------	---	---------

**MICRA IV**

1.2	1.2	59	05.10–	HR12DE	3	ZSE 088
-----	-----	----	--------	--------	---	---------

**MURANO**

3.5 4x4	3.5	172	08.03–	VQ35DE	6	ZSE 079
---------	-----	-----	--------	--------	---	---------

**NOTE**

1.6	1.6	81	03.06–	HR16DE	4	ZSE 056
-----	-----	----	--------	--------	---	---------

**PATHFINDER (R50)**

3.3 V6 4WD	3.3	110	03.98–10.00	VG33E	6	ZSE 076
3.3 V6 4WD	3.3	125	09.97–12.04	VG33E	6	ZSE 076
3.5 V6 4WD	3.5	162	11.00–12.04	VQ35	6	ZSE 076
3.5 V6 4WD	3.5	162	01.03–12.04	VQ35	6	ZSE 079

**PATHFINDER (R51)**

4.0 4WD	4.0	198	09.05–	VQ40DE	6	ZSE 134 <sup>202</sup>
---------	-----	-----	--------	--------	---	------------------------

**PATROL GR I**

4.2 KAT	4.2	121	11.88–06.97	TB42E	6	ZS 376
---------	-----	-----	-------------	-------	---	--------

**PATROL Hardtop (K160)**

2.8	2.8	88	07.80–08.88	L28	6	ZS 109
-----	-----	----	-------------	-----	---	--------





kW



NISSAN							
<b>PATROL Hardtop (K160)</b>							
2.8	2.8	89	07.80-08.88	L28	6		ZS 109
<b>PATROL Hardtop (K260)</b>							
2.8	2.8	88	05.86-06.90	L28	6		ZS 110
<b>PRAIRIE PRO</b>							
2.0 i	2.0	72	10.88-04.92	CA20E	4		ZS 277
2.4 i	2.4	98	04.92-07.94	KA24E	4	ZM 048	ZS 277
<b>PRIMERA (P10)</b>							
1.6	1.6	66	06.90-01.96	GA16DS	4	ZM 049 <sup>286</sup>	ZS 277
1.6	1.6	71	06.90-01.96	GA16DS	4		ZS 277
1.6	1.6	75	06.93-01.96	GA16DE	4		ZS 277
2.0 16V	2.0	85	05.93-04.93	SR20DI	4	ZM 048 <sup>287</sup>	ZS 277
2.0 16V	2.0	85	05.93-06.94	SR20DI	4	ZM 048 <sup>286</sup>	ZS 277
2.0 16V 4x4	2.0	85	05.93-06.94	SR20DI	4	ZM 048	
2.0 16V 4x4	2.0	85	04.91-06.96	SR20DI	4		ZS 277
2.0 GT	2.0	110	06.90-01.96	SR20DE	4	ZM 048	ZS 277
2.0 i	2.0	92	01.95-06.96	SR20DE	4	ZM 048	
<b>PRIMERA (P11)</b>							
1.6 16V	1.6	66	09.96-12.01	GA16DE	4		ZS 277
1.6 16V	1.6	73	09.96-10.00	GA16DE	4		ZS 277
1.6 16V	1.6	78	09.00-12.01	QG16DE	4		ZSE 081
1.8 16V	1.8	84	08.99-09.00	QG18DE	4		ZSE 021
1.8 16V	1.8	84	10.00-12.01	QG18DE	4		ZSE 081
2.0 16V	2.0	85	09.96-12.01	SR20De	4	ZM 048	
2.0 16V	2.0	96	09.96-12.01	SR20DE	4	ZM 048	
2.0 16V	2.0	103	08.99-12.01	SR20DE	4	ZM 048	
2.0 16V	2.0	110	09.96-12.01	SR20DE	4	ZM 048	ZS 277
<b>PRIMERA (P12)</b>							
1.6	1.6	78	03.02-06.10	QG16DE	4		ZSE 081
1.6	1.6	80	01.02-06.10	QG16DE	4		ZSE 081
1.8	1.8	85	03.02-	QG18DE	4		ZSE 021
1.8	1.8	85	03.02-	QG18DE	4		ZSE 081
2.0	2.0	103	03.02-	QR20DE	4		ZSE 080
<b>QASHQAI / QASHQAI +2 (J10, JJ10)</b>							
1.6	1.6	84	02.07-	HR16DE	4		ZSE 056
2.0	2.0	103	02.07-	MR20DE	4		ZSE 056
2.0	2.0	104	11.10-	MR20DE	4		ZSE 088
<b>SERENA</b>							
1.6 16V	1.6	71	02.93-09.94	GA16DE	4		ZS 277
1.6 16V	1.6	71	02.93-09.01	GA16DE	4	ZM 048	
1.6 16V	1.6	71	10.94-09.01	GA16DE	4		ZS 376
2.0 16V	2.0	93	11.92-09.01	SR20DE	4	ZM 048	ZS 277
<b>STANZA</b>							
1.6	1.6	60	01.85-12.85	CA16S	4	ZM 048	
1.8 SGL	1.8	66	01.85-12.85	CA18S	4	ZM 048	
<b>SUNNY I</b>							
1.5	1.5	55	03.82-10.86	E15S	4		ZS 109
<b>SUNNY II</b>							
1.4 LX	1.4	55	10.88-08.91	GA14S	4		ZS 109
1.6 i	1.6	54	06.86-10.90	E16i	4		ZS 511
<b>SUNNY III</b>							
1.4 i	1.4	55	10.90-05.95	GA14DE / GA14DS	4	ZM 048	ZS 277
1.6 i	1.6	66	10.90-05.95	GA16DE , GA16DS	4		ZS 277
<b>TEANA I</b>							
2.0	2.0	103	10.03-06.08	QR20DE	4		ZSE 080
<b>TERRANO I</b>							
3.0 i 4WD	3.0	109	01.90-12.95	VG30E	6	ZM 048	ZS 277
<b>TERRANO II</b>							
2.4 i 12V 4WD	2.4	91	02.93-06.96	KA24E	4	ZM 048	ZS 277
<b>TIIDA Schrägheck</b>							
1.5	1.5	80	05.04-02.07	HR15DE	4		ZSE 088



kW

**NISSAN**
**TIIDA Schrägheck (C11X)**

1.6	1.6	81	09.07–	HR16DE	4		<b>ZSE 056</b>	
1.8	1.8	93	09.07–	MR18DE	4		<b>ZSE 056</b>	

**TIIDA Stufenheck (SC11X)**

1.6	1.6	81	09.07–	HR16DE	4		<b>ZSE 056</b>	
1.8	1.8	93	09.07–	MR18DE	4		<b>ZSE 056</b>	

**TITAN**

5.6	5.6	227	10.03–	VK56DE	8		<b>ZSE 134<sup>202</sup></b>	
5.6	5.6	237	09.06–	VK56DE	8		<b>ZSE 134<sup>202</sup></b>	
5.6 Flex-Fuel 4WD	5.6	224	01.04–12.07	VK56DE	8		<b>ZSE 134<sup>202</sup></b>	

**X-TRAIL (T30)**

2.0	2.0	103	07.01–	QR20DE	4		<b>ZSE 080</b>	
2.5 4x4	2.5	121	01.03–	QR25DE	4		<b>ZSE 080</b>	

**X-TRAIL (T31)**

2.0	2.0	103	06.08–	MR20DE	4		<b>ZSE 056</b>	
2.0	2.0	104	06.07–	MR20DE	4		<b>ZSE 056</b>	

**KUBISTAR**

1.2	1.1	44	08.03–	D7F 764	4		<b>ZS 052<sup>282</sup></b>	<b>GS 29</b>
1.2	1.1	44	08.03–	D7F 764	4		<b>ZS 354</b>	
1.2 16V	1.1	55	04.06–	D4F 712	4		<b>ZS 354</b>	
1.6 16V	1.6	70	08.03–	K4M 752	4		<b>ZS 052<sup>282</sup></b>	<b>GS 29</b>

**PRIMASTAR**

2.0	2.0	88	03.01–	F4R 722/F4R 720	4		<b>ZS 052<sup>282</sup></b>	<b>GS 29</b>
-----	-----	----	--------	-----------------	---	--	-----------------------------	--------------

**VANETTE**

1.5	1.5	51	10.86–06.94	A15S	4		<b>ZS 109</b>	
1.6 i	1.6	72	01.96–	GA16DE	4		<b>ZS 277</b>	

**OPEL**
**AGILA (A)**

1.0	1.0	44	08.03–12.07	Z 10 XEP	3		<b>ZS 359</b>	
1.0 12V	1.0	43	09.00–12.07	Z 10 XE	3		<b>ZS 358</b>	
1.2 16V	1.2	55	09.00–12.07	Z 12 XE	4		<b>ZSE 147</b>	
1.2 16V Twinport	1.2	59	07.04–12.07	Z 12 XEP	4		<b>ZS 338</b>	

**ASCONA C**

1.3 N	1.3	44	09.81–08.86	13 N	4	<b>ZM 006</b>	<b>ZS 252</b>	
1.3 S	1.3	55	09.81–08.88	13 S	4	<b>ZM 006</b>	<b>ZS 252</b>	
1.6	1.6	55	09.81–09.87	16 N	4	<b>ZM 002</b>	<b>ZS 252</b>	
1.6	1.6	55	09.83–09.87	16 N	4	<b>ZM 015</b>	<b>ZS 252</b>	
1.6 i	1.6	55	09.87–08.88	E 16 NZ/E 16 LZ	4	<b>ZM 016</b>	<b>ZS 252</b>	
1.6 i KAT	1.6	55	09.86–08.88	C 16 NZ/C 16 LZ	4	<b>ZM 016</b>	<b>ZS 252</b>	
1.6 S	1.6	66	09.81–08.86	16 SH	4	<b>ZM 002</b>		
1.6 S	1.6	66	09.83–08.86	16 SH	4	<b>ZM 015</b>		
1.8 E	1.8	74	01.85–08.86	S 18 NV/C 18 NE	4	<b>ZM 032</b>		
1.8 i	1.8	85	09.82–08.86	18 E	4	<b>ZM 002</b>		
1.8 i	1.8	85	09.82–08.86	18 E	4	<b>ZM 015</b>		

**ASTRA F**

1.4	1.4	60	09.92–09.98	14 SE	4		<b>ZS 253</b>	
1.4 i	1.4	44	09.91–09.98	C 14 NZ/X 14 NZ	4	<b>ZM 018</b>	<b>ZS 253</b>	
1.4 i	1.4	44	09.91–09.98	C 14 NZ	4		<b>ZSE 026</b>	
1.4 i 16V	1.4	66	02.96–09.98	X 14 XE	4		<b>ZSE 026</b>	
1.4 Si	1.4	60	03.92–09.98	C 14 SE Mot.Nr.→02T14052	4	<b>ZM 018</b>		
1.4 Si	1.4	60	03.92–09.98	C 14 SE	4		<b>ZS 253</b>	
1.4 Si	1.4	60	03.92–09.98	C 14 SE Mot.Nr.02T14053→	4		<b>ZSE 026</b>	
1.6 i	1.6	52	05.93–07.96	X 16 SZ	4		<b>ZSE 026</b>	
1.6 i	1.6	55	03.92–09.98	C 16 NZ/X 16 SZR	4	<b>ZM 016</b>	<b>ZS 252</b>	
1.6 i	1.6	55	03.92–09.98	C 16 NZ	4		<b>ZSE 026</b>	
1.6 i 16V	1.6	74	08.94–09.98	X 16 XEL	4		<b>ZSE 026</b>	
1.6 Si	1.6	74	05.92–12.94	C 16 SE	4		<b>ZSE 026</b>	



kW



## OPEL

## ASTRA F

1.8 i	1.8	66	03.92-09.98	C 18 NZ	4	ZM 018	ZS 253
1.8 i 16V	1.8	85	11.94-09.98	C 18 XEL/X 18 XE	4		ZS 344
1.8 i 16V	1.8	92	06.93-10.94	C 18 XE	4		ZS 344
2.0 i 16V	2.0	100	02.95-09.98	X 20 XEV	4	ZM 026	ZS 344

## ASTRA F Cabriolet

1.4 i 16V	1.4	66	01.96-03.01	X 14 XE	4		ZSE 026
1.4 Si	1.4	60	05.93-03.01	C 14 SE	4	ZM 018	ZS 253
1.4 Si	1.4	60	05.93-03.01	C 14 SE Mot.Nr.02T14053→	4		ZSE 026
1.6 i	1.6	52	03.93-08.96	X 16 SZ	4		ZSE 026
1.6 i	1.6	55	01.96-03.01	X 16 SZR	4		ZSE 026
1.8 i 16V	1.8	85	11.94-03.01	C 18 XEL/X 18 XE	4		ZS 344

## ASTRA F Caravan

1.4	1.4	60	09.92-01.98	14 SE	4		ZS 253
1.4 i	1.4	44	09.91-01.98	C 14 NZ	4	ZM 018	ZS 253
1.4 i	1.4	44	09.91-01.98	C 14 NZ	4		ZSE 026
1.4 i 16V	1.4	66	02.96-01.98	X 14 XE	4		ZSE 026
1.4 Si	1.4	60	03.92-01.98	C 14 SE	4	ZM 018	ZS 253
1.4 Si	1.4	60	03.92-01.98	C 14 SE Mot.Nr.02T14053→	4		ZSE 026
1.6	1.6	55	09.95-01.98	16 NZR/16 LZ2	4		ZS 253
1.6 i	1.6	52	05.93-07.96	X 16 SZ	4		ZSE 026
1.6 i	1.6	55	09.91-01.98	C 16 NZ	4	ZM 016	ZS 252
1.6 i	1.6	55	09.91-01.98	C 16 NZ/X 16 SZR	4		ZSE 026
1.6 i 16V	1.6	74	08.94-01.98	X 16 XEL	4		ZSE 026
1.6 Si	1.6	74	03.92-12.94	C 16 SE	4		ZSE 026
1.8 i	1.8	66	09.91-01.98	C 18 NZ	4	ZM 018	ZS 253
1.8 i 16V	1.8	85	07.94-01.98	C 18 XEL	4		ZS 344
1.8 i 16V	1.8	92	06.93-02.96	C 18 XE	4		ZS 344
2.0 i 16V	2.0	100	02.95-01.98	X 20 XEV	4	ZM 026	ZS 344
2.0 i 16V	2.0	110	03.93-01.98	C 20 XE Mot.Nr.14137013→	4	ZM 034	ZS 300

## ASTRA G

1.0	1.0	44	08.03-05.04	Z 10 XEP	3		ZS 359
1.4	1.4	66	09.07-12.09	Z 14 XEP	4		ZS 338
1.4 16V	1.4	66	02.98-01.05	X 14 XE/Z 14 XE	4		ZS 259 GS 39
1.6	1.6	55	02.98-09.00	X 16 SZR	4		ZSE 026
1.6	1.6	70	06.02-03.04	Z 16 YNG	4		ZS 259 GS 39
1.6	1.6	76	12.02-12.09	Z 16 XEP	4		ZS 427
1.6 16V	1.6	74	02.98-01.05	X 16 XEL	4		ZS 259 GS 39
1.8	1.8	81	02.03-01.04	Z 18 XEL	4		ZS 342
1.8 16V	1.8	85	02.98-09.00	X 18 XE1	4		ZS 342
1.8 16V	1.8	92	09.00-01.05	Z 18 XE	4		ZS 342
2.0 16V	2.0	100	02.98-01.05	X 20 XEV/C 20 SEL	4		ZS 344
2.0 16V OPC	2.0	118	11.99-09.02	X 20 XER	4		ZS 344

## ASTRA G Cabriolet

1.6	1.6	76	01.03-10.05	Z 16 XEP	4		ZS 427
1.6 16V	1.6	74	03.01-10.05	Z 16 XE Mot.Nr.→41000000	4		ZS 259 GS 39
1.8 16V	1.8	92	03.01-10.05	Z 18 XE	4		ZS 342
2.0 16V Turbo	2.0	147	11.02-10.05	Z 20 LET	4		ZSE 151
2.0 OPC	2.0	141	03.02-10.05	Z 20 LET	4		ZSE 151

## ASTRA G Caravan

1.2 16V	1.2	48	02.98-09.00	X 12 XE	4		ZSE 147
1.2 16V	1.2	55	09.00-09.03	Z 12 XE	4		ZSE 147
1.4	1.4	66	09.07-12.09	Z 14 XEP	4		ZS 338
1.4 16V	1.4	66	06.98-07.04	X 14 XE/Z 14 XE	4		ZS 259 GS 39
1.6	1.6	55	02.98-09.00	X 16 SZR	4		ZSE 026
1.6	1.6	76	12.05-07.09	Z 16 XEP	4		ZS 427
1.6 16V	1.6	74	02.98-07.04	X 16 XEL	4		ZS 259 GS 39
1.6 CNG	1.6	71	03.03-07.04	Z 16 YNG	4		ZS 259 GS 39
1.8	1.8	81	02.03-07.04	Z 18 XEL	4		ZS 342



kW

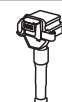

## OPEL

## ASTRA G Caravan

1.8 16V	1.8	85	02.98–09.00	X 18 XE1	4		ZS 342	
1.8 16V	1.8	92	09.00–07.04	Z 18 XE	4		ZS 342	
2.0 16V	2.0	100	02.98–07.04	X 20 XEV	4		ZS 344	
2.0 OPC	2.0	141	09.02–07.04	Z 20 LET	4		ZSE 151	
2.0 OPC	2.0	147	11.02–07.04	Z 20 LET	4		ZSE 151	

## ASTRA G Coupe

1.6 16V	1.6	74	03.00–05.05	Z 16 XE Mot.Nr.→41000000	4		ZS 259	GS 39
1.6 16V	1.6	76	03.00–05.05	Z 16 XEP	4		ZS 427	
1.8 16V	1.8	85	03.00–10.00	X 18 XE1	4		ZS 342	
1.8 16V	1.8	92	09.00–05.05	Z 18 XE	4		ZS 342	
2.0 16V Turbo	2.0	140	09.00–08.01	Z 20 LET	4		ZSE 151	
2.0 16V Turbo	2.0	141	08.01–05.05	Z 20 LET	4		ZSE 151	
2.0 16V Turbo	2.0	147	11.02–05.05	Z 20 LET	4		ZSE 151	

## ASTRA H

1.2	1.2	59	08.05–	Z 12 XEP	4		ZS 338	
1.4	1.4	66	03.04–	Z 14 XEP	4		ZS 338	
1.6	1.6	77	03.04–	Z 16 XEP	4		ZS 427	
1.6	1.6	85	12.06–	Z 16 XER , A 16 XER	4		ZS 427	
1.6 CNG	1.6	69	11.05–	Z 16 YNG	4		ZS 259	GS 39
1.6 Turbo	1.6	132	02.07–	Z 16 LET	4		ZS 427	
1.8	1.8	92	03.04–	Z 18 XE	4		ZS 342	
1.8	1.8	103	01.06–	Z 18 XER/A 18 XER	4		ZS 427	
2.0 Turbo	2.0	125	03.04–	Z 20 LEL	4		ZSE 151	
2.0 Turbo	2.0	147	09.04–	Z 20 LER	4		ZSE 151	
2.0 Turbo	2.0	177	03.05–	Z 20 LEH	4		ZSE 151	

## ASTRA H Caravan

1.4 LPG	1.4	66	08.09–	Z 14 XEP	4		ZS 338	
1.6	1.6	77	08.04–	Z 16 XEP	4		ZS 427	
1.6	1.6	85	12.06–	Z 16 XER , A 16 XER	4		ZS 427	
1.6 CNG	1.6	69	11.05–	Z 16 YNG	4		ZS 259	GS 39
1.6 LPG	1.6	85	08.09–	Z 16 XER	4		ZS 427	
1.6 Turbo	1.6	132	02.07–	Z 16 LET	4		ZS 427	
1.8	1.8	92	08.04–	Z 18 XE	4		ZS 342	
1.8	1.8	103	08.05–	Z 18 XER/A 18 XER	4		ZS 427	
2.0 Turbo	2.0	125	08.04–	Z 20 LEL	4		ZSE 151	
2.0 Turbo	2.0	147	09.04–	Z 20 LER	4		ZSE 151	

## ASTRA H GTC

1.2	1.2	59	08.05–	Z 12 XEP	4		ZS 338	
1.4	1.4	66	03.05–	Z 14 XEP	4		ZS 338	
1.6	1.6	77	12.05–	Z 16 XEP	4		ZS 427	
1.6	1.6	85	12.06–	Z 16 XER	4		ZS 427	
1.6 CNG	1.6	69	11.05–	Z 16 YNG	4		ZS 259	GS 39
1.6 Turbo	1.6	132	02.07–	Z 16 LET	4		ZS 427	
1.8	1.8	103	01.06–	Z 18 XER	4		ZS 427	
2.0 Turbo	2.0	125	03.05–	Z 20 LEL	4		ZSE 151	
2.0 Turbo	2.0	147	03.05–	Z 20 LER	4		ZSE 151	
2.0 Turbo	2.0	177	08.05–	Z 20 LEH	4		ZSE 151	

## ASTRA H TwinTop

2.0 Turbo	2.0	125	09.05–	Z 20 LEL	4		ZSE 151	
2.0 Turbo	2.0	147	09.05–	Z 20 LER	4		ZSE 151	

## CALIBRA A

2.0 i	2.0	85	06.90–07.97	C 20 NE Mot.Nr.→14180385	4		ZS 125	
2.0 i	2.0	85	06.90–07.97	C 20 NE Mot.Nr.14180386→	4		ZS 127	
2.0 i 16V	2.0	100	02.94–07.97	X 20 XEV Mot.Nr.14028515→	4	ZM 034	ZS 344	
2.0 i 16V	2.0	110	06.90–02.94	C 20 XE Fgst.Nr.P1000001→ Mot.Nr.14028515→	4	ZM 034	ZS 300	



kW



**OPEL**

**CALIBRA A**

2.0 i 4x4	2.0	85	06.90-07.97	C 20 NE Mot.Nr.14028515→	4	<b>ZM 034</b>	
2.0 i 4x4	2.0	85	06.90-07.97	C 20 NE Mot.Nr.→14180385	4		<b>ZS 125</b>
2.0 i 4x4	2.0	85	06.90-07.97	C 20 NE Mot.Nr.14180386→	4		<b>ZS 127</b>
2.0 i Turbo 4x4	2.0	150	03.92-07.97	C 20 LET	4	<b>ZM 034</b>	
2.5 i V6	2.5	125	04.93-07.97	X 25 XE/C 25 XE	6		<b>ZS 301</b>

**COMBO**

1.2	1.2	33	07.94-10.01	C 12 NZ	4		<b>ZSE 026</b>
1.4	1.4	44	07.94-08.00	C 14 NZ	4		<b>ZS 253</b>
1.4	1.4	44	07.94-10.01	X 14 SZ	4		<b>ZSE 026</b>
1.4	1.4	60	07.94-10.01	C 14 SE	4		<b>ZSE 026</b>

**CORSA A**

1.2	1.2	33	09.82-08.90	12NC	4	<b>ZM 001</b>	
1.2	1.2	33	09.82-08.90	E 12 GV/12 NC	4	<b>ZM 006</b>	<b>ZS 253</b> <sup>283,287</sup>
1.2 N	1.2	38	01.90-03.93	12 NV	4		<b>ZS 252</b>
1.2 i	1.2	33	09.89-03.93	C 12 NZ	4		<b>ZS 253</b> <sup>283,287</sup>
1.2 S	1.2	40	01.85-02.90	12 ST	4	<b>ZM 006</b>	
1.3 i	1.3	44	09.86-09.90	C 13 N	4	<b>ZM 016</b>	<b>ZS 252</b>
1.3 S	1.3	51	09.82-07.85	13 SB	4	<b>ZM 006</b>	
1.3 S	1.3	51	08.85-10.89	13 SB	4	<b>ZM 007</b>	
1.4 i	1.4	40	01.85-03.93	C 14 NZ	4	<b>ZM 015</b>	
1.4 i	1.4	40	01.85-03.93	C 14 NZ	4	<b>ZM 018</b>	
1.4 i	1.4	44	01.90-03.93	C 14 NZ	4	<b>ZM 041</b>	<b>ZS 253</b> <sup>287</sup>
1.4 S	1.4	53	01.90-03.93	14 NV	4		<b>ZS 253</b> <sup>283,287</sup>
1.4 Si	1.4	60	09.91-03.93	C 14 SE	4	<b>ZM 041</b>	<b>ZS 253</b>
1.4 Si	1.4	60	09.91-03.93	C 14 SE Mot.Nr.02T14053→	4	<b>ZM 041</b>	<b>ZSE 026</b>
1.6 GSI	1.6	72	09.89-03.93	C 16 SEI	4	<b>ZM 016</b>	<b>ZS 253</b>
1.6 GSI	1.6	74	04.89-03.92	E 16 SE	4	<b>ZM 016</b>	
1.6 GSI	1.6	74	05.88-03.92	E 16 SE	4		<b>ZS 253</b>
1.6 GSI	1.6	74	05.88-03.92	E 16 SE Fgst.Nr.L4000001→	4		<b>ZSE 026</b>
1.6 GSI KAT	1.6	74	02.92-03.93	C 16 SE	4	<b>ZM 016</b>	<b>ZS 253</b>
1.6 GSI KAT	1.6	74	02.92-03.93	C 16 SE Fgst.Nr.L4000001→	4	<b>ZM 016</b>	<b>ZSE 026</b>

**CORSA B**

1.0 i 12V	1.0	40	11.96-09.00	X 10 XE	3		<b>ZS 358</b>
1.2 i	1.2	33	03.93-09.00	12 NZ	4	<b>ZM 041</b>	<b>ZS 253</b>
1.2 i	1.2	33	03.93-09.00	C 12 NZ/X 12 SZ	4	<b>ZM 018</b>	<b>ZS 253</b>
1.2 i	1.2	33	03.93-09.00	X 12 SZ	4		<b>ZSE 026</b>
1.2 i 16V	1.2	48	03.98-09.00	X 12 XE	4		<b>ZSE 147</b>
1.4 i	1.4	44	03.93-09.00	C 14 NZ	4	<b>ZM 018</b>	<b>ZS 253</b>
1.4 i	1.4	44	03.93-09.00	C 14 NZ	4	<b>ZM 041</b>	<b>ZS 253</b>
1.4 i	1.4	44	03.93-09.00	X 14 SZ	4		<b>ZSE 026</b>
1.4 i 16V	1.4	66	09.94-09.00	X 14 XE	4		<b>ZSE 026</b>
1.4 Si	1.4	60	03.93-09.00	C 14 SE	4		<b>ZS 253</b>
1.4 Si	1.4	60	03.93-09.00	C 14 SE	4		<b>ZSE 026</b>
1.6 GSI 16V	1.6	80	03.93-09.00	C 16 XE	4		<b>ZSE 026</b>
1.6 i 16V	1.6	78	09.94-09.00	X 16 XE	4		<b>ZSE 026</b>

**CORSA C**

1.0	1.0	43	09.00-	Z 10 XE	3		<b>ZS 358</b>
1.0	1.0	44	06.03-	Z 10 XEP	3		<b>ZS 359</b>
1.2	1.2	55	09.00-06.04	Z 12 XE Fgst.Nr.→33999999 , 34999999 , 36999999	4		<b>ZSE 147</b>
1.2 Twinport	1.2	59	07.04-	Z 12 XEP	4		<b>ZS 338</b>
1.4	1.4	66	09.00-	Z 14 XE	4		<b>ZS 259</b> <b>GS 39</b>
1.4 Twinport	1.4	66	06.03-	Z 14 XEP	4		<b>ZS 338</b>
1.6	1.6	71	08.05-07.06	Z 16 YNG	4		<b>ZS 259</b> <b>GS 39</b>
1.8	1.8	92	09.00-	Z 18 XE	4		<b>ZS 342</b>



kW



OPEL							
<b>CORSA D</b>							
1.0	1.0	44	07.06–	Z 10 XEP	3		<b>ZS 359</b>
1.2	1.2	51	06.10–	A 12 XEL	4		<b>ZS 338</b>
1.2	1.2	59	07.06–	Z 12 XEP	4		<b>ZS 338</b>
1.2	1.2	63	06.10–	A 12 XER	4		<b>ZS 338</b>
1.2 LPG	1.2	59	09.09–	Z 12 XEP	4		<b>ZS 338</b>
1.4	1.4	64	09.09–	A 14 XEL	4		<b>ZS 338</b>
1.4	1.4	74	06.10–	A 14 XER	4		<b>ZS 338</b>
1.4 LPG	1.4	66	07.06–	Z 14 XEP	4		<b>ZS 338</b>
1.6 Turbo	1.6	110	02.07–	Z 16 LEL/A 16 LEL	4		<b>ZS 427</b>
1.6 Turbo	1.6	141	02.07–	Z 16 LER , A 16 LER	4		<b>ZS 427</b>
1.6 Turbo	1.6	155	06.11–	Z 16 LER , A 16 LER	4		<b>ZS 427</b>
<b>FRONTERA A</b>							
2.2 i	2.2	100	03.95–10.98	X 22 XE Fgst.Nr.SV 720103→	4		<b>ZS 300</b>
2.4 i	2.4	92	03.92–10.98	C 24 NE	4		<b>ZS 127</b>
<b>FRONTERA A Sport</b>							
2.0 i	2.0	85	03.92–10.98	C 20 NE	4		<b>ZS 127</b>
2.0 i	2.0	85	03.92–10.98	X 20 SE	4		<b>ZS 300</b>
<b>INSIGNIA</b>							
1.6 Turbo	1.6	132	07.08–	A 16 LET Fgst.Nr.→B1999999	4		<b>ZS 427</b>
<b>INSIGNIA Sports Tourer</b>							
1.6 Turbo	1.6	132	01.09–	A 16 LET Fgst.Nr.→B1999999	4		<b>ZS 427</b>
<b>KADETT E</b>							
1.3 i KAT	1.3	44	09.85–08.89	C 13 N	4	<b>ZM 016</b>	
1.3 N	1.3	44	09.84–08.91	13 NB/13 N	4		<b>ZS 252</b>
1.3 S	1.3	55	09.84–08.87	13 S	4	<b>ZM 006</b>	
1.4 i	1.4	44	09.90–08.91	C 14 NZ	4	<b>ZM 041</b>	
1.4 i	1.4	44	01.90–08.91	C 14 NZ	4	<b>ZM 018</b>	<b>ZS 253</b> <sup>283,287</sup>
1.4 S	1.4	55	01.90–08.91	14 NV	4	<b>ZM 015</b>	<b>ZS 253</b>
1.4 S	1.4	55	01.90–08.91	14 NV	4	<b>ZM 018</b>	<b>ZS 253</b>
1.6 i	1.6	55	09.87–08.91	E 16 NZ	4	<b>ZM 016</b>	
1.6 i	1.6	55	09.86–08.91	E 16 NZ	4	<b>ZM 018</b>	<b>ZS 252</b>
1.6 i KAT	1.6	55	09.87–08.91	C 16 NZ/C 16 LZ	4	<b>ZM 016</b>	
1.6 i KAT	1.6	55	09.86–08.91	C 16 NZ/C 16 LZ	4	<b>ZM 018</b>	<b>ZS 252</b>
1.6 S	1.6	60	09.86–08.87	16 SV	4	<b>ZM 007</b>	
1.6 S	1.6	60	01.90–08.91	16 SV	4		<b>ZS 253</b> <sup>283</sup>
1.6 S	1.6	66	09.84–08.86	16 SH	4	<b>ZM 002</b>	
1.6 S	1.6	66	09.84–08.86	16 SH	4	<b>ZM 015</b>	
1.8	1.8	84	09.87–08.90	18 E	4		<b>ZS 127</b>
1.8	1.8	84	09.87–08.90	18 E	4		<b>ZS 253</b>
1.8 i	1.8	66	09.90–08.91	C 18 NT	4	<b>ZM 015</b>	
1.8 S	1.8	62	09.87–08.88	E 18 NV	4		<b>ZS 125</b>
1.8 S	1.8	62	09.88–08.91	E 18 NV	4		<b>ZS 127</b>
1.8 S	1.8	62	09.87–12.90	E 18 NV	4	<b>ZM 034</b>	
2.0 i	2.0	85	03.87–08.88	20 NE/20 SE	4		<b>ZS 125</b>
2.0 i	2.0	85	09.88–08.91	20 NE/20 SE	4		<b>ZS 127</b>
2.0 i KAT	2.0	85	03.87–08.88	C 20 NE	4		<b>ZS 125</b>
2.0 i KAT	2.0	85	09.88–08.91	C 20 NE	4		<b>ZS 127</b>
<b>KADETT E Cabriolet</b>							
1.3 S	1.3	55	03.87–02.93	13 S	4	<b>ZM 006</b>	
1.4 i	1.4	44	01.90–08.91	C 14 NZ	4	<b>ZM 041</b>	<b>ZS 253</b> <sup>283,287</sup>
1.6 i	1.6	55	09.87–02.93	E 16 NZ	4	<b>ZM 016</b>	
1.6 i	1.6	55	10.86–02.93	E 16 NZ	4	<b>ZM 018</b>	
1.6 i KAT	1.6	55	10.87–02.93	C 16 NZ/C 16 LZ	4	<b>ZM 016</b>	<b>ZS 252</b>
1.6 i KAT	1.6	55	10.87–02.93	C 16 NZ/C 16 LZ	4	<b>ZM 018</b>	<b>ZS 252</b>
2.0 i	2.0	85	09.88–02.93	20 NE	4		<b>ZS 127</b>
2.0 i	2.0	85	10.86–08.88	20 NE	4		<b>ZS 125</b>
2.0 i KAT	2.0	85	09.88–02.93	C 20 NE	4		<b>ZS 127</b>
2.0 i KAT	2.0	85	10.86–08.88	C 20 NE	4		<b>ZS 125</b>



kW



**OPEL**

**KADETT E Caravan**

1.3 i KAT	1.3	44	09.85-08.89	C 13 N	4	ZM 016		
1.3 S	1.3	55	09.84-08.87	13 S	4	ZM 006		
1.4 i	1.4	44	01.90-08.91	C 14 NZ	4	ZM 018	ZS 253 <sup>283,287</sup>	
1.4 S	1.4	55	01.90-08.91	14 NV	4	ZM 015	ZS 253	
1.4 S	1.4	55	01.90-08.91	14 NV	4	ZM 018	ZS 253	
1.6 i	1.6	55	09.87-08.91	E 16 NZ	4	ZM 016		
1.6 i	1.6	55	09.86-08.91	E 16 NZ	4	ZM 018	ZS 252	
1.6 i KAT	1.6	55	09.87-08.91	C 16 NZ/C 16 LZ	4	ZM 016		
1.6 i KAT	1.6	55	09.86-08.91	C 16 NZ/C 16 LZ	4	ZM 018	ZS 252	
1.6 S	1.6	66	09.84-08.86	16 SH	4	ZM 002		
1.6 S	1.6	66	09.84-08.86	16 SH	4	ZM 015		
1.8 i	1.8	66	01.89-08.91	C 18 NZ/C 18 NT	4	ZM 018		
1.8 i	1.8	66	06.85-09.85	C18NT	4	ZM 001		
1.8 S	1.8	62	09.87-08.88	E 18 NV	4		ZS 125	
1.8 S	1.8	62	01.89-08.91	E 18 NV	4	ZM 034		
1.8 S	1.8	62	09.88-08.91	E 18 NV	4		ZS 127	
2.0 i	2.0	85	09.87-08.88	20 NE	4		ZS 125	
2.0 i	2.0	85	09.88-08.91	20 NE	4		ZS 127	
2.0 i KAT	2.0	85	09.87-08.88	C 20 NE	4		ZS 125	
2.0 i KAT	2.0	85	09.88-08.91	C 20 NE	4		ZS 127	

**MANTA B**

1.3 S	1.3	55	01.82-08.86	13 S	4	ZM 006		
1.3 S	1.3	55	08.81-08.86	13 S	4	ZM 002	ZS 252	
1.8 S	1.8	66	07.82-08.87	18 S	4	ZM 002		
2.0 S	2.0	74	08.77-08.84	20 S	4	ZM 002		

**MERIVA**

1.4 16V Twinport	1.4	66	07.04-05.10	Z 14 XEP	4		ZS 338	
1.4 16V Twinport LPG	1.4	66	07.04-05.10	Z 14 XEP	4		ZS 338	
1.6	1.6	77	01.06-05.10	Z 16 XEP	4		ZS 427	
1.6 16V	1.6	74	05.03-05.10	Z16XE	4		ZS 259	GS 39
1.6 Turbo	1.6	132	09.05-05.10	Z 16 LET	4		ZS 427	
1.8	1.8	92	05.03-05.10	Z 18 XE	4		ZS 342	

**MONZA A**

2.2 E	2.2	85	11.84-08.86	22 E	4	ZM 015		
2.5 E	2.5	100	05.81-08.86	H 25 E	6	ZM 002		
2.5 E	2.5	100	09.84-08.86	H 25 E	6	ZM 015		
2.5 E	2.5	103	06.84-08.86	25 E	6	ZM 002		
2.5 E	2.5	103	09.84-08.86	25 E	6	ZM 015		
3.0 GSE	3.0	115	09.85-08.86	C 30 LE	6	ZM 002		
3.0 GSE	3.0	115	09.85-08.86	C 30 LE	6	ZM 015		
3.0 GSE	3.0	132	08.81-08.86	30 E	6	ZM 002		
3.0 GSE	3.0	132	09.83-08.86	30 E	6	ZM 015		

**OMEGA A**

1.8	1.8	65	09.87-03.94	E 18 NVR	4	ZM 034	ZS 125	
1.8	1.8	65	09.87-03.94	E 18 NVR Mot.Nr.14258180→	4	ZM 034	ZS 127	
1.8	1.8	85	09.86-03.94	18 SEH	4	ZM 034	ZS 253	
1.8 N	1.8	60	09.86-08.87	18 NV	4	ZM 032	ZS 125	
1.8 N	1.8	60	09.86-08.87	18 NV Mot.Nr.14258180	4	ZM 032	ZS 127	
1.8 S	1.8	66	09.86-03.94	18 SV	4	ZM 032	ZS 253	
2.0	2.0	73	09.90-03.94	C 20 NEJ Mot.Nr.→14180385	4		ZS 125	
2.0	2.0	73	09.90-03.94	C 20 NEJ Mot.Nr.14180386→	4		ZS 127	
2.0	2.0	74	09.90-03.94	C 20 NEF Mot.Nr.→14180385	4	ZM 034	ZS 125	
2.0	2.0	74	09.90-03.94	C 20 NEF Mot.Nr.14180386→	4		ZS 127	
2.0	2.0	90	09.86-03.94	20 SE Mot.Nr.→14180385	4		ZS 125	



kW



OPEL							
OMEGA A							
2.0	2.0	90	09.86-03.94	20 SE Mot.Nr.14180386→	4		ZS 127
2.0 i	2.0	85	09.86-03.94	C 20 NE Mot.Nr.→14180385	4		ZS 125
2.0 i	2.0	85	09.86-03.94	C 20 NE Mot.Nr.14180386→	4		ZS 127
2.4 i	2.4	92	09.88-03.94	C 24 NE Fgst.Nr.→K1999999	4		ZS 127
2.4 i	2.4	92	09.88-03.94	C 24 NE Fgst.Nr.L1000001→	4		ZS 125
3.0	3.0	115	03.87-12.87	C 30 LE Fgst.Nr.K1000099→ Fgst.Nr.→K1999999	6		ZS 125
3.0	3.0	115	03.87-12.87	C 30 LE Fgst.Nr.L1000001→	6		ZS 127
3.0	3.0	130	03.87-08.89	30 NE	6	ZM 001	
3.0	3.0	130	03.87-09.90	30 NE	6		ZS 125
3.0	3.0	130	03.87-09.90	30 NE	6		ZS 127
3.0	3.0	130	03.88-03.94	C 30 NE Fgst.Nr.K1000099→ Fgst.Nr.→K1999999	6		ZS 125
3.0	3.0	130	03.88-03.94	C 30 NE Fgst.Nr.L1000001→	6		ZS 127
3.0 24V	3.0	147	09.89-03.94	C 30 SEJ	6		ZS 127
3.0 24V	3.0	150	09.89-03.94	C 30 SE	6		ZS 127
3.0 24V Evolution500	3.0	169	03.91-07.92	C 30 XEI	6		ZS 127
3.6 24V Lotus	3.6	277	08.90-09.92	C 36 GET	6		ZS 355
OMEGA A Caravan							
1.8	1.8	65	09.87-03.94	E 18 NVR	4	ZM 034	ZS 125
1.8	1.8	65	09.87-03.94	E 18 NVR Mot.Nr.14258180→	4	ZM 034	ZS 127
1.8	1.8	85	09.86-03.94	18 SEH	4	ZM 032	
1.8 N	1.8	60	09.86-08.87	18 NV	4	ZM 032	ZS 125
1.8 N	1.8	60	09.86-08.87	18 NV Mot.Nr.14258180→	4	ZM 032	ZS 127
1.8 S	1.8	66	09.86-03.94	18 SV	4	ZM 032	
2.0	2.0	74	09.90-03.94	C 20 NEF Mot.Nr.→14180385	4		ZS 125
2.0	2.0	74	09.90-03.94	C 20 NEF Mot.Nr.14180386→	4		ZS 127
2.0	2.0	90	09.86-03.94	20 SE Mot.Nr.→14180385	4		ZS 125
2.0	2.0	90	09.86-03.94	20 SE Mot.Nr.14180386→	4		ZS 127
2.0 i	2.0	73	09.90-03.94	C 20 NEJ Mot.Nr.→14180385	4		ZS 125
2.0 i	2.0	73	09.90-03.94	C 20 NEJ Mot.Nr.14180386→	4		ZS 127
2.0 i	2.0	85	09.86-03.94	C 20 NE Mot.Nr.→14180385	4		ZS 125
2.0 i	2.0	85	09.86-03.94	C 20 NE Mot.Nr.14180386→	4		ZS 127
2.4 i	2.4	92	09.88-03.94	C 24 NE Fgst.Nr.→K1999999	4		ZS 127
2.4 i	2.4	92	09.88-03.94	C 24 NE Fgst.Nr.L1000001→	4		ZS 125
3.0	3.0	115	03.87-03.94	C 30 LE Fgst.Nr.K1000099→ Fgst.Nr.→K1999999	6		ZS 125
3.0	3.0	115	03.87-03.94	C 30 LE Fgst.Nr.L1000001→	6		ZS 127
3.0	3.0	130	03.87-09.90	30 NE	6		ZS 125
3.0	3.0	130	03.87-09.90	30 NE	6		ZS 127





kW



**OPEL**

**OMEGA A Caravan**

3.0 KAT	3.0	130	03.87-03.94	C 30 NE Fgst.Nr.K1000099→ Fgst.Nr.→K1999999	6	<b>ZS 125</b>
3.0 KAT	3.0	130	03.87-03.94	C 30 NE Fgst.Nr.L1000001→	6	<b>ZS 127</b>

**OMEGA B**

2.0	2.0	85	03.94-09.99	X 20 SE	4	<b>ZS 300</b>
2.0	2.0	85	03.94-12.00	20 SE	4	<b>ZS 300</b>
2.0 16V	2.0	100	03.94-09.99	X 20 XEV	4	<b>ZS 344</b>
2.2 16V	2.2	106	09.99-07.03	Y 22 XE/Z 22 XE	4	<b>ZSE 150</b>
2.5 V6	2.5	125	03.94-09.00	X 25 XE	6	<b>ZS 301<sup>202</sup></b>
2.5 V6	2.5	125	03.94-09.00	X 25 XE	6	<b>ZS 306<sup>202</sup></b>
2.5 V6	2.5	125	03.94-09.00	X 25 XE	6	<b>ZS 451<sup>202</sup></b>
2.6 V6	2.6	132	09.00-07.03	Y 26 SE	6	<b>ZSE 152</b>
2.6 V6	2.6	132	09.00-07.03	Y 26 SE	6	<b>ZSE 153</b>
3.0 V6	3.0	155	04.94-02.01	X 30 XE	6	<b>ZS 301<sup>202</sup></b>
3.0 V6	3.0	155	04.94-02.01	X 30 XE	6	<b>ZS 306<sup>202</sup></b>
3.0 V6	3.0	155	04.94-02.01	X 30 XE	6	<b>ZS 451<sup>202</sup></b>
3.2 V6	3.2	160	02.01-07.03	Y 32 SE	6	<b>ZSE 152</b>
3.2 V6	3.2	160	02.01-07.03	Y 32 SE	6	<b>ZSE 153</b>

**OMEGA B Caravan**

2.0	2.0	85	03.94-09.99	X 20 SE	4	<b>ZS 300</b>
2.0 16V	2.0	100	03.94-09.99	X 20 XEV	4	<b>ZS 344</b>
2.2 16V	2.2	106	09.99-07.03	Y 22 XE/Z 22 XE	4	<b>ZSE 150</b>
2.5 V6	2.5	125	03.94-09.00	X 25 XE	6	<b>ZS 301<sup>202</sup></b>
2.5 V6	2.5	125	03.94-09.00	X 25 XE	6	<b>ZS 306<sup>202</sup></b>
2.5 V6	2.5	125	03.94-09.00	X 25 XE	6	<b>ZS 451<sup>202</sup></b>
2.6 V6	2.6	132	09.00-07.03	Y 26 SE	6	<b>ZSE 152</b>
2.6 V6	2.6	132	09.00-07.03	Y 26 SE	6	<b>ZSE 153</b>
3.0 V6	3.0	155	04.94-02.01	X 30 XE	6	<b>ZS 301<sup>202</sup></b>
3.0 V6	3.0	155	04.94-02.01	X 30 XE	6	<b>ZS 306<sup>202</sup></b>
3.0 V6	3.0	155	04.94-02.01	X 30 XE	6	<b>ZS 451<sup>202</sup></b>
3.2 V6	3.2	160	02.01-07.03	Y 32 SE	6	<b>ZSE 152</b>
3.2 V6	3.2	160	02.01-07.03	Y 32 SE	6	<b>ZSE 153</b>

**SENATOR A**

2.0 E	2.0	85	03.83-10.84	H 20 E	4	<b>ZM 002</b>
2.2 E	2.2	85	11.84-08.87	22 E	4	<b>ZM 015</b>
2.5 E	2.5	100	01.83-08.84	H 25 E	6	<b>ZM 002</b>
3.0 E	3.0	132	02.78-12.86	30 E	6	<b>ZM 002</b>

**SENATOR B**

2.5 i	2.5	103	09.90-09.93	25 NE	6	<b>ZM 015</b>	<b>ZS 127</b>
2.6 i	2.6	110	09.90-09.93	C 26 NE	6	<b>ZM 015</b>	<b>ZS 127</b>
3.0	3.0	115	09.87-09.93	C 30 LE Fgst.Nr.K1000099→ Fgst.Nr.→K1999999	6	<b>ZM 015</b>	<b>ZS 125</b>
3.0	3.0	115	09.87-09.93	C 30 LE Fgst.Nr.L1000001→	6		<b>ZS 127</b>
3.0	3.0	130	01.88-09.90	30 NE	6	<b>ZM 015</b>	
3.0 24V	3.0	150	09.89-09.93	C 30 SE	6	<b>ZM 015</b>	<b>ZS 127</b>
3.0 i KAT	3.0	130	01.88-09.93	C 30 NE Fgst.Nr.K1000099→ Fgst.Nr.→K1999999	6	<b>ZM 015</b>	<b>ZS 125</b>
3.0 i KAT	3.0	130	01.88-09.93	C 30 NE Fgst.Nr.L1000001→	6	<b>ZM 015</b>	<b>ZS 127</b>

**SIGNUM**

1.8	1.8	90	05.03-	Z 18 XE	4		<b>ZS 342</b>
1.8	1.8	103	09.05-	Z 18 XER	4		<b>ZS 427</b>
2.2 direct	2.2	114	05.03-09.08	Z 22 YH	4		<b>ZSE 149</b>

**SINTRA**

2.2 i 16V	2.2	104	11.96-04.99	X 22 XE	4		<b>ZS 450</b>
-----------	-----	-----	-------------	---------	---	--	---------------

**SPEEDSTER**

2.0 Turbo	2.0	147	04.03-09.06	Z 20 LET	4		<b>ZSE 151</b>
-----------	-----	-----	-------------	----------	---	--	----------------



kW



OPEL							
<b>TIGRA</b>							
1.4 16V	1.4	66	07.94–12.00	X 14 XE	4		<b>ZSE 026</b>
1.6 16V	1.6	78	07.94–08.98	X 16 XE	4		<b>ZSE 026</b>
<b>TIGRA TwinTop</b>							
1.4	1.4	66	06.04–	Z 14 XEP	4		<b>ZS 338</b>
1.8	1.8	92	06.04–	Z 18 XE	4		<b>ZS 342</b>
<b>VECTRA A</b>							
1.6	1.6	60	01.90–05.93	16 SV	4		<b>ZS 253</b> <sup>287</sup>
1.6	1.6	60	09.88–07.92	16 SV	4	<b>ZM 018</b>	
1.6	1.6	60	09.88–12.90	16 SV	4		<b>ZS 252</b> <sup>283</sup>
1.6 i	1.6	52	09.93–11.95	X 16 SZ	4		<b>ZSE 026</b>
1.6 i	1.6	55	09.88–11.95	C 16 NZ2/C 16 NZ/E 16 NZ	4	<b>ZM 016</b>	<b>ZS 252</b>
1.6 i	1.6	55	09.93–11.95	16 LZ2	4		<b>ZS 253</b>
1.8 i KAT	1.8	66	03.90–11.95	C 18 NZ	4		<b>ZS 253</b>
1.8 S	1.8	65	09.88–07.89	E 18 NVR	4		<b>ZS 125</b>
1.8 S	1.8	66	09.89–10.90	18 SV	4		<b>ZS 253</b>
1.8 S 4x4	1.8	65	01.89–07.89	E 18 NVR	4		<b>ZS 125</b>
1.8 S 4x4	1.8	65	01.89–07.89	E 18 NVR	4		<b>ZS 253</b>
2.0	2.0	74	09.88–09.89	C 20 NEF Mot.Nr.→14180385	4		<b>ZS 125</b>
2.0	2.0	74	09.88–09.89	C 20 NEF Mot.Nr.14180386→	4		<b>ZS 127</b>
2.0 i	2.0	85	09.88–10.90	20 NE Mot.Nr.→14180385	4		<b>ZS 125</b>
2.0 i	2.0	85	09.88–10.90	20 NE Mot.Nr.14180386→	4		<b>ZS 127</b>
2.0 i	2.0	95	09.88–09.92	20 SEH Mot.Nr.→14180385	4		<b>ZS 125</b>
2.0 i	2.0	95	09.88–09.92	20 SEH Mot.Nr.14180386→	4		<b>ZS 127</b>
2.0 i 16V	2.0	100	06.94–11.95	X 20 XEV	4	<b>ZM 026</b>	<b>ZS 344</b>
2.0 i 4x4	2.0	85	01.89–10.90	20 NE Mot.Nr.→14180385	4		<b>ZS 125</b>
2.0 i 4x4	2.0	85	01.89–10.90	20 NE Mot.Nr.14180386→	4		<b>ZS 127</b>
2.0 i 4x4	2.0	95	01.89–09.92	20 SEH Mot.Nr.→14180385	4		<b>ZS 125</b>
2.0 i 4x4	2.0	95	01.89–09.92	20 SEH Mot.Nr.14180386→	4		<b>ZS 127</b>
2.0 i 4x4 KAT	2.0	85	01.89–11.95	C 20 NE Mot.Nr.→14180385	4		<b>ZS 125</b>
2.0 i 4x4 KAT	2.0	85	01.89–11.95	C 20 NE Mot.Nr.14180386→	4		<b>ZS 127</b>
2.0 i KAT	2.0	85	09.88–11.95	C 20 NE Mot.Nr.→14180385	4		<b>ZS 125</b>
2.0 i KAT	2.0	85	09.88–11.95	C 20 NE Mot.Nr.14180386→	4		<b>ZS 127</b>
2.0 i Turbo 4x4	2.0	150	06.94–11.95	C 20 LET	4	<b>ZM 034</b>	<b>ZS 127</b>
2.5 V6	2.5	125	02.93–08.94	C 25 XE	6		<b>ZS 301</b>
2000 16V 4x4	2.0	110	09.89–10.90	20 XEJ	4	<b>ZM 034</b>	
2000 16V 4x4	2.0	110	01.89–10.90	20 XEJ	4		<b>ZS 127</b>
2000/GT 16V	2.0	110	01.89–06.94	20 XEJ	4		<b>ZS 127</b>
2000/GT 16V	2.0	110	09.89–08.92	20 XEJ	4	<b>ZM 034</b>	
2000/GT 16V 4x4 KAT	2.0	110	02.90–08.92	C 20 XE Fgst.Nr.P1000001→	4		<b>ZS 300</b>
2000/GT 16V 4x4 KAT	2.0	110	02.90–11.95	C 20 XE	4	<b>ZM 034</b>	
2000/GT 16V KAT	2.0	110	02.90–11.95	C 20 XE Fgst.Nr.P1000001→	4	<b>ZM 034</b>	<b>ZS 300</b>
<b>VECTRA B</b>							
1.6 i	1.6	55	10.95–04.02	X 16 SZR	4		<b>ZSE 026</b>
1.6 i 16V	1.6	74	10.95–04.02	Z 16 XE/X 16 XEL/Y 16 XE	4		<b>ZS 259</b> <b>GS 39</b>
1.8 i 16V	1.8	85	10.95–09.00	X 18 XE1	4		<b>ZS 342</b>
1.8 i 16V	1.8	85	10.95–09.00	X 18 XE	4		<b>ZS 344</b>
1.8 i 16V	1.8	92	09.00–04.02	Z 18 XE	4		<b>ZS 342</b>



kW



**OPEL**

**VECTRA B**

2.0 i	2.0	82	10.95-04.02	20 NEJ	4		<b>ZS 300</b>	
2.0 i 16V	2.0	100	10.95-09.00	X 20 XEV/C 20 SEL	4	<b>ZM 026</b>	<b>ZS 344</b>	
2.5 i V6	2.5	125	10.95-09.00	X 25 XE	6		<b>ZS 451</b>	
2.6 i V6	2.6	125	09.00-04.02	Y 26 SE	6		<b>ZSE 152</b>	
2.6 i V6	2.6	125	09.00-04.02	Y 26 SE	6		<b>ZSE 153</b>	
i 500 2.5	2.5	143	05.98-09.00	X 25 XE	6		<b>ZS 451</b>	

**VECTRA B Caravan**

1.6 i	1.6	55	11.96-06.00	X 16 SZR	4		<b>ZSE 026</b>	
1.6 i 16V	1.6	74	11.96-07.02	Z 16 XE/X 16 XEL/Y 16 XE	4		<b>ZS 259</b>	<b>GS 39</b>
1.8 i 16V	1.8	85	11.96-09.00	X 18 XE	4		<b>ZS 344</b>	
1.8 i 16V	1.8	85	11.96-09.00	X 18 XE1	4	<b>ZM 026</b>	<b>ZS 342</b>	
1.8 i 16V	1.8	92	09.00-07.03	Z 18 XE	4		<b>ZS 342</b>	
2.0 i 16V	2.0	100	11.96-09.00	X 20 XEV	4		<b>ZS 344</b>	
2.5 i V6	2.5	125	11.96-09.00	X 25 XE	6		<b>ZS 451</b>	
2.6 i V6	2.6	125	09.00-09.02	Y 26 SE	6		<b>ZSE 152</b>	
2.6 i V6	2.6	125	09.00-09.02	Y 26 SE	6		<b>ZSE 153</b>	
i 500 2.5	2.5	143	05.98-09.00	X 25 XE	6		<b>ZS 451</b>	

**VECTRA C**

1.6	1.6	77	01.06-	Z 16 XEP	4		<b>ZS 427</b>	
1.6 16V	1.6	74	06.04-	Z16XE	4		<b>ZS 259</b>	<b>GS 39</b>
1.8	1.8	81	04.02-	Z 18 XEL	4		<b>ZS 342</b>	
1.8	1.8	103	01.06-	Z 18 XER	4		<b>ZS 427</b>	
1.8 16V	1.8	90	04.02-	Z 18 XE	4		<b>ZS 342</b>	
2.2 direct	2.2	114	10.03-10.08	Z 22 YH	4		<b>ZSE 149</b>	

**VECTRA C Caravan**

1.6	1.6	77	01.06-	Z 16 XEP	4		<b>ZS 427</b>	
1.6 16V	1.6	74	06.04-	Z16XE	4		<b>ZS 259</b>	<b>GS 39</b>
1.8	1.8	90	10.03-	Z 18 XE	4		<b>ZS 342</b>	
1.8	1.8	103	01.06-	Z 18 XER	4		<b>ZS 427</b>	
2.2 direct	2.2	114	10.03-10.08	Z 22 YH	4		<b>ZSE 149</b>	

**VECTRA C GTS**

1.8	1.8	103	01.06-	Z 18 XER	4		<b>ZS 427</b>	
1.8 16V	1.8	90	08.02-	Z 18 XE	4		<b>ZS 342</b>	
2.2 direct	2.2	114	10.03-10.08	Z 22 YH	4		<b>ZSE 149</b>	

**ZAFIRA A**

1.6	1.6	70	09.02-06.05	Z 16 YNG	4		<b>ZS 259</b>	<b>GS 39</b>
1.6 16V	1.6	74	04.99-06.05	X 16 XEL	4		<b>ZS 259</b>	<b>GS 39</b>
1.6 CNG	1.6	71	09.01-06.05	Z 16 YNG	4		<b>ZS 259</b>	<b>GS 39</b>
1.8	1.8	81	02.03-06.05	Z 18 XEL	4		<b>ZS 342</b>	
1.8 16V	1.8	85	04.99-09.00	X 18 XE1	4		<b>ZS 342</b>	
1.8 16V	1.8	92	09.00-06.05	Z 18 XE	4		<b>ZS 342</b>	
2.0 OPC	2.0	141	09.01-06.05	Z 20 LET	4		<b>ZSE 151</b>	
2.0 OPC	2.0	147	11.02-06.05	Z 20 LET/Z 20 LER	4		<b>ZSE 151</b>	

**ZAFIRA B**

1.6	1.6	77	07.05-	Z 16 XE1/Z 16 XEP	4		<b>ZS 427</b>	
1.6	1.6	85	01.08-	Z 16 XER	4		<b>ZS 427</b>	
1.6 CNG	1.6	69	01.06-	Z 16 YNG	4		<b>ZS 259</b>	<b>GS 39</b>
1.6 CNG Turbo	1.6	110	02.09-	Z 16 XNT , A 16 XNT	4		<b>ZS 427</b>	
1.8	1.8	103	07.05-	Z 18 XER , A 18 XER	4		<b>ZS 427</b>	
2.0	2.0	147	07.05-	Z 20 LER	4		<b>ZSE 151</b>	
2.0	2.0	177	01.06-	Z 20 LEH	4		<b>ZSE 151</b>	
2.2	2.2	110	07.05-	Z 22 YH	4		<b>ZSE 149</b>	

**ZAFIRA C**

1.6 CNG	1.6	110	10.11-	A 16 XNT	4		<b>ZS 427</b>	
---------	-----	-----	--------	----------	---	--	---------------	--



**VIVARO**

2.0 16V	2.0	88	08.01-	F4R 720	4		<b>ZS 052<sup>282</sup></b>	<b>GS 29</b>
2.0 ECOTEC	2.0	86	08.06-	F4R 820	4		<b>ZS 052<sup>282</sup></b>	<b>GS 29</b>



kW

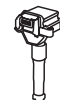

## PEUGEOT

PEUGEOT							
<b>104</b>							
1.0	1.0	32	09.83-06.88	108C (XV8)	4		ZS 110
1.1	1.1	37	08.80-06.88	109F (XW7)	4	ZM 001	ZS 110
<b>104 Coupe</b>							
1.1	1.1	37	08.79-06.88	109F (XW7)	4	ZM 001	ZS 110
<b>106 I</b>							
1.0	1.0	33	07.92-04.96	TU9/CDY (TU9M)	4	ZM 003	ZS 231
1.0	1.0	33	09.91-04.96	TU9/CDY (TU9M)	4	ZM 003 <sup>283</sup>	ZS 249 <sup>283,288</sup>
1.1	1.1	44	09.91-04.96	HDZ (TU1M)	4	ZM 003	
1.1	1.1	44	01.93-04.96	HDZ (TU1M)	4		ZS 231
1.1	1.1	44	09.91-12.92	HDZ (TU1M)	4		ZS 249 <sup>283,285</sup>
1.3	1.3	72	10.93-04.96	TU2J2	4	ZM 003	ZS 231
1.4	1.4	55	09.91-02.94	KDX (TU3MC)/KDY (TU3M)	4	ZM 003	ZS 249
1.4	1.4	55	09.91-02.94	KDX (TU3MC)/KDY (TU3M)	4	ZM 026	ZS 249
1.4	1.4	55	03.94-04.96	KDX (TU3MC)/KDY (TU3M)	4		ZS 231
1.4	1.4	69	09.91-04.96	KFZ (TU3J2/Z)	4		ZS 231
1.6	1.6	65	06.93-04.96	NFZ (TU5JP) Fgst.Nr.→3200	4		ZS 231
1.6	1.6	76	01.94-04.96	NFY (TU5J2)	4		ZS 231
<b>106 II</b>							
1.0 i	1.0	33	05.96-	CDY (TU9M)	4		ZS 232
1.0 i	1.0	37	01.97-	CDZ (TU9M)	4	ZM 003	ZS 232
1.1 i	1.1	40	01.97-	HDY (TU1M)	4		ZS 232
1.1 i	1.1	44	05.96-	HDZ (TU1M)/HFX (TU1JP)	4		ZS 232
1.1 i	1.1	44	05.96-	HDZ (TU1M)/HFX (TU1JP)	4		ZSE 047
1.4 i	1.4	55	03.98-05.05	KFX (TU3JP)/KFW (TU3JP)	4		ZS 381
1.4 i	1.4	55	05.96-	KFX (TU3JP)/KFW (TU3JP) Org.Nr.→7727	4		ZS 232
1.4 i	1.4	55	05.96-	KFX (TU3JP)/KFW (TU3JP)	4		ZSE 047
1.6 i	1.6	65	05.96-	NFZ (TU5JP) Fgst.Nr.→3200	4		ZS 232
1.6 i	1.6	74	05.96-	NFW (TU5J2)/NFY (TU5J2)	4		ZS 231
1.6 S16	1.6	87	05.96-	NFX (TU5J4) Fgst.Nr.51450→	4		ZS 241
1.6 S16	1.6	87	05.96-	NFX (TU5J4)	4		ZSE 046
<b>205 I</b>							
1.1	1.1	36	02.83-10.87	109N (XW7)	4	ZM 003	
1.1	1.1	37	02.83-10.87	109F (XW7)	4	ZM 001	
1.4	1.4	44	02.83-10.87	150D (XY7)/150G (XY7)	4	ZM 001	
1.4	1.4	58	10.85-10.87	150H (XY8)	4	ZM 001	
1.4	1.4	59	02.83-10.87	150B (XY8)	4	ZM 001	
1.6	1.6	53	03.87-10.87	B1E (XU51C)	4	ZM 003	
1.6	1.6	55	08.86-10.87	B1A (XU51C)	4	ZM 003	
1.6 GTI	1.6	76	12.84-10.87	180A (XU5J)	4	ZM 003	
1.9 GTI	1.9	94	10.86-10.87	D6B (XU9JA (ohne KAT))	4	ZM 003	
<b>205 I Cabriolet</b>							
1.1 CJ	1.1	44	10.89-12.94	HDZ (TU1M)	4	ZM 003 <sup>283</sup>	ZS 247 <sup>283</sup>
1.4 CJ	1.4	44	03.88-05.89	150D (XY7)/150G (XY7)	4	ZM 003	
1.4 CJ	1.4	49	03.89-12.94	K1D (TU3A)	4	ZM 003	
1.4 CJ	1.4	55	05.91-12.94	KDZ (TU3M)/KDY (TU3M)	4	ZM 003 <sup>283</sup>	ZS 247 <sup>283</sup>
1.4 CJ KAT	1.4	44	01.89-12.92	KAY (TU3CP)	4	ZM 003	ZS 247
1.4 CT	1.4	58	04.86-12.88	150B (XY8)/150H (XY8)	4	ZM 003	
1.6 CJ	1.6	65	08.92-12.94	BDY (XU5M3Z)	4	ZM 003	ZS 232
1.9 CTI	1.9	75	10.87-12.94	DFZ (XU9J1)	4	ZM 003	
1.6 CTI	1.6	76	04.86-10.90	180A (XU5J)/180Z (XU5J)	4	ZM 003	
<b>205 II</b>							
1.0	1.0	33	10.87-09.98	TU9	4	ZM 003 <sup>283</sup>	ZS 247 <sup>283</sup>
1.0	1.0	33	01.91-12.94	TU9	4		ZS 231
1.1	1.1	36	10.87-10.90	109N (XW7)	4	ZM 003	
1.1	1.1	40	10.87-10.90	H1B (TU1)	4	ZM 003 <sup>283</sup>	ZS 247 <sup>283</sup>
1.1	1.1	44	07.89-09.98	HDZ (TU1M)	4	ZM 003 <sup>283</sup>	ZS 247 <sup>283</sup>
1.1	1.1	44	01.91-12.94	HDZ (TU1M)	4		ZS 231
1.4	1.4	44	10.87-05.89	150D (XY7)/150G (XY7)	4	ZM 001	



kW



**PEUGEOT**

**205 II**

1.4	1.4	49	10.87-10.90	K1D (TU3A)	4	ZM 003	ZS 247
1.4	1.4	55	08.90-01.96	KDX (TU3MC)	4		ZS 231
1.4	1.4	55	08.90-07.98	KDX (TU3MC)	4	ZM 003	
1.4	1.4	55	02.96-07.98	KDX (TU3MC)/TU32	4		ZS 232
1.4	1.4	55	01.91-09.98	KFX (TU3JP)/KDZ (TU3M)/KDY (TU3M)	4	ZM 003	ZS 231
1.4	1.4	55	07.88-09.98	KFX (TU3JP)/KDZ (TU3M)/KDY (TU3M)	4	ZM 003	ZS 247
1.4	1.4	58	07.88-05.89	150B (XY8)/150H (XY8)	4	ZM 001	
1.4	1.4	62	06.87-12.89	K2B (TU3S)	4	ZM 003	
1.4 KAT	1.4	44	08.87-09.93	KAY (TU3CP)	4	ZM 003	ZS 247
1.6	1.6	53	01.91-12.94	B1E (XU51C)	4		ZS 232
1.6 Aut.	1.6	65	05.90-09.98	BDY (XU5M2Z)/BDY (XU5M3Z)	4	ZM 003	
1.6 Aut.	1.6	65	05.90-12.94	BDY (XU5M2Z)/BDY (XU5M3Z)	4		ZS 232
1.6 GTI	1.6	76	10.88-12.89	180A (XU5J)/180Z (XU5J)	4	ZM 003	
1.9 GTI	1.9	75	10.87-05.89	D2A (XU92C)	4	ZM 003	
1.9 GTI	1.9	88	10.87-10.94	DKZ (XU9JAZ)	4	ZM 003	
1.9 GTI	1.9	94	10.87-09.98	D6B (XU9JA)	4	ZM 003	
1.9 GTI KAT	1.9	75	10.87-07.94	DFZ (XU9J1)	4	ZM 001	

**206**

1.1 i	1.1	44	09.98-	HFZ (TU1JP)/HFX (TU1JP)	4		ZS 381
1.1 i	1.1	44	09.98-	HFZ (TU1JP)/HFX (TU1JP)	4		ZSE 047
1.4 i	1.4	55	09.98-05.00	KFX (TU3JP)	4		ZS 381
1.4 i	1.4	55	06.00-	KFW (TU3JP)	4		ZSE 047
1.6 16V	1.6	80	12.00-	NFU (TU5JP4)	4		ZSE 045
1.6 i	1.6	65	09.98-12.00	NFZ (TU5JP) Fgst.Nr.→3200	4		ZS 231
1.6 i	1.6	65	09.98-12.00	NFZ (TU5JP)	4		ZS 381
2.0 RC	2.0	130	07.03-	RFK (EW10J4S)	4		ZS 351
2.0 S16	2.0	99	04.99-10.00	RFR (DEW10J4)	4		ZS 348
2.0 S16	2.0	100	10.00-	RFN (EW10J4)	4		ZS 348

**206 SW**

1.1	1.1	44	07.02-	HFX (TU1JP)	4		ZSE 047
1.4	1.4	55	07.02-	KFV (TU3A)/KFW (TU3JP)	4		ZSE 047
1.6 16V	1.6	80	07.02-	NFU (TU5JP4)	4		ZSE 045
2.0 16V	2.0	100	07.02-	RFN (EW10J4)	4		ZS 348

**206+**

1.1	1.1	44	01.09-	HFX (TU1A)/HFX (TU1JP)/TU1AE5	4		ZSE 048
1.4 i	1.4	54	09.10-	KFT (TU3A)	4		ZSE 048
1.4 i	1.4	55	01.09-	KFV (TU3A) , KFW (TU3A)	4		ZSE 048

**207**

1.4	1.4	53	02.06-	KFV (TU3A)	4		ZSE 048
1.4	1.4	55	08.08-	KFV (TU3A) , KFW (TU3A)	4		ZSE 048
1.4 16V	1.4	70	06.07-	EP3C/EP3	4		ZSE 143
1.6 16V	1.6	80	02.06-	NFU (TU5JP4)	4		ZSE 045
1.6 16V VTi	1.6	88	03.07-	5FS (EP6C)/EP6	4		ZSE 143

**207 SW**

1.4	1.4	54	06.07-	KFV (TU3A)	4		ZSE 048
-----	-----	----	--------	------------	---	--	---------

**208**

1.4	1.4	70	03.12-	EP3C	4		ZSE 143
1.6	1.6	88	03.12-		4		ZSE 143

**305 II**

1.3	1.3	44	10.82-08.85	118 (XL5)	4	ZM 001	ZS 110
1.5	1.5	50	09.85-07.90	142 (XR5A)	4	ZM 001	ZS 110
1.5	1.5	54	10.82-08.85	142 (XR5)	4	ZM 001	ZS 110
1.6	1.6	55	10.82-07.88	B1A (XU51C)	4	ZM 001	
1.6	1.6	66	07.84-08.87	171 (XU5S)	4	ZM 001	
1.9	1.9	75	10.82-08.85	159 (XU9S)	4	ZM 001	

**305 II Break**

1.3	1.3	44	10.82-08.86	118 (XL5)	4	ZM 001	ZS 110
1.5	1.5	50	09.85-10.86	142 (XR5A)	4	ZM 001	
1.5	1.5	54	10.82-08.86	142 (XR5)	4	ZM 001	ZS 110
1.6	1.6	54	11.86-12.88	BAZ (XU5CP)	4	ZM 001	

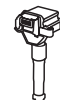

kW

**PEUGEOT****305 II Break**

1.6	1.6	55	02.86–12.88	B1A (XU51C)	4	<b>ZM 001</b>	
1.6	1.6	66	07.84–12.87	171 (XU5S)	4	<b>ZM 001</b>	
1.9	1.9	75	09.84–10.87	159 (XU9S)	4	<b>ZM 001</b>	

**306**

1.1	1.1	44	06.94–05.01	HDZ (TU1M)	4		<b>ZS 231</b>
1.1	1.1	44	06.94–05.01	HDZ (TU1M)	4		<b>ZS 232</b>
1.4 SL	1.4	55	06.94–05.01	KDX (TU3MC)	4		<b>ZS 231</b>
1.4 SL	1.4	55	06.94–05.01	KFW (TU3JP), KFX (TU3JP)	4		<b>ZS 232</b>
1.4 SL	1.4	55	06.94–05.01	KFW (TU3JP), KFX (TU3JP) Org.Nr.07875→	4		<b>ZS 381</b>
1.6	1.6	72	10.00–05.01	NFT	4		<b>ZSE 047</b>
1.6 SR	1.6	65	06.94–10.00	NFZ (TU5JP) Fgst.Nr.→3200	4		<b>ZS 231</b>
1.6 SR	1.6	65	07.98–10.00	NFZ (TU5JP)	4		<b>ZS 381</b>
1.8 16V	1.8	81	03.97–05.01	LFY (XU7JP4) Org.Nr.→07608	4	<b>ZM 026</b>	<b>ZS 256</b>
1.8 16V	1.8	81	03.97–05.01	LFY (XU7JP4) Org.Nr.07609→	4	<b>ZM 026</b>	<b>ZS 349</b>
1.8 ST	1.8	74	06.94–05.01	LFZ (XU7JP)	4		<b>ZS 232</b>
2.0	2.0	97	03.97–05.01	RFV (XU10J4R)	4		<b>ZS 232</b>
2.0	2.0	97	09.97–05.01	RFV (XU10J4R)	4		<b>ZS 349</b>
2.0 S16	2.0	110	06.94–05.01	XU10J4TEZ	4		<b>ZS 323</b>
2.0 S16	2.0	112	06.94–05.01	RFY (XU10J4Z)	4		<b>ZS 232</b>

**306**

2.0 ST	2.0	89	07.94–05.01	RFX (XU10J2)	4		<b>ZS 232</b>
--------	-----	----	-------------	--------------	---	--	---------------

**306 Break**

1.4	1.4	55	03.97–04.02	KFW (TU3JP), KFX (TU3JP) Org.Nr.→07874	4		<b>ZS 232</b>
1.4	1.4	55	03.97–04.02	KFW (TU3JP), KFX (TU3JP) Org.Nr.07875→	4		<b>ZS 381</b>
1.6	1.6	65	03.97–10.00	NFZ (TU5JP) Fgst.Nr.→3200	4		<b>ZS 231</b>
1.6	1.6	65	07.98–10.00	NFZ (TU5JP)	4		<b>ZS 381</b>
1.6	1.6	72	10.00–04.02	NFT	4		<b>ZSE 047</b>
1.8	1.8	74	03.97–04.02	LFZ (XU7JP)	4		<b>ZS 232</b>
1.8 16V	1.8	81	03.97–04.02	LFY (XU7JP4) Org.Nr.→07608	4		<b>ZS 256</b>
1.8 16V	1.8	81	03.97–04.02	LFY (XU7JP4) Org.Nr.07609→	4		<b>ZS 349</b>
2.0	2.0	97	09.97–04.02	RFV (XU10J4R)	4		<b>ZS 232</b>
2.0	2.0	97	03.97–04.02	RFV (XU10J4R)	4		<b>ZS 349</b>

**306 Cabriolet**

1.6	1.6	65	04.96–10.00	NFZ (TU5JP) Fgst.Nr.→3200	4		<b>ZS 231</b>
1.6	1.6	65	07.98–10.00	NFZ (TU5JP)	4		<b>ZS 381</b>
1.8	1.8	74	03.94–04.02	LFZ (XU7JP)	4		<b>ZS 232</b>
1.8 16V	1.8	81	07.00–04.02	LFY (XU7JP4) Org.Nr.→07608	4	<b>ZM 026</b>	<b>ZS 256</b>
1.8 16V	1.8	81	07.00–04.02	LFY (XU7JP4) Org.Nr.07609→	4	<b>ZM 026</b>	<b>ZS 349</b>
2.0	2.0	89	03.94–04.02	RFX (XU10J2)	4		<b>ZS 232</b>
2.0 16V	2.0	97	03.97–04.02	RFV (XU10J4R)	4		<b>ZS 232</b>
2.0 16V	2.0	97	09.97–04.02	RFV (XU10J4R)	4		<b>ZS 349</b>

**307**

1.4	1.4	55	09.01–	KFW (TU3JP)	4		<b>ZSE 047</b>
1.6 16V	1.6	80	08.00–	NFU (TU5JP4)	4		<b>ZSE 045</b>
2.0 16V	2.0	100	03.01–	RFN (EW10J4)	4		<b>ZS 348</b>
2.0 16V	2.0	103	03.05–	RFJ (EW10A)	4		<b>ZS 352</b>
2.0 16V	2.0	130	06.05–	RFK (EW10J4S)	4		<b>ZS 351</b>

**307 Break**

1.6 16V	1.6	80	03.02–	NFU (TU5JP4)	4		<b>ZSE 045</b>
2.0	2.0	100	03.02–	RFN (EW10J4)	4		<b>ZS 348</b>
2.0	2.0	100	03.05–	RFN (EW10J4)	4		<b>ZS 352</b>



kW

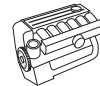

**PEUGEOT**

<b>307 Break</b>							
2.0 16V	2.0	103	03.05-	RFJ (EW10A)	4		<b>ZS 352</b>
2.0 16V	2.0	130	06.05-	RFK (EW10J4S)	4		<b>ZS 351</b>
<b>308</b>							
1.4 16V	1.4	70	09.07-03.10	EP3	4		<b>ZSE 143</b>
1.4 16V	1.4	72	04.10-		4		<b>ZSE 143</b>
1.6 16V	1.6	88	09.07-	EP6	4		<b>ZSE 143</b>
<b>308 SW</b>							
1.4 16V	1.4	70	05.08-03.10	8FS (EP3)	4		<b>ZSE 143</b>
1.4 16V	1.4	72	12.09-		4		<b>ZSE 143</b>
1.6 16V	1.6	88	05.08-	EP6	4		<b>ZSE 143</b>
1.6 Bioflex	1.6	82	03.09-	NFU (TU5JP4)	4		<b>ZSE 045</b>
<b>309 I</b>							
1.1	1.1	40	10.85-07.89	E1	4	<b>ZM 001</b>	<b>ZS 257</b>
1.3	1.3	47	10.85-07.89	G1A	4	<b>ZM 001</b>	
1.4	1.4	49	03.89-07.89	K1D (TU3A)	4	<b>ZM 003</b>	
1.4	1.4	62	03.89-07.89	K2B (TU3S)	4	<b>ZM 003</b>	
1.6	1.6	53	08.87-07.89	B1E (XU51C)	4	<b>ZM 001</b>	
1.6	1.6	55	10.85-07.89	B1A (XU51C)	4	<b>ZM 003</b>	
1.6	1.6	76	04.86-09.88	180Z (XU5J)/B6B (XU5J)	4	<b>ZM 001</b>	<b>ZS 247</b>
1.6	1.6	69	01.86-07.89		4		<b>ZS 257</b>
1.9	1.9	72	03.86-07.89	DFZ (XU9J1)	4	<b>ZM 001</b>	
1.9 GTI	1.9	94	10.86-07.89	D6B (XU9JA)	4	<b>ZM 001</b>	
<b>309 II</b>							
1.1	1.1	44	08.90-12.93	HDZ (TU1M)	4	<b>ZM 003</b> <sup>283</sup>	<b>ZS 247</b> <sup>283</sup>
1.1	1.1	44	08.90-12.93	HDZ (TU1M)	4	<b>ZM 003</b>	<b>ZS 257</b>
1.4	1.4	49	07.90-12.93	K1D (TU3A)	4		<b>ZS 247</b>
1.4	1.4	55	06.90-12.93	KDZ (TU3M)/KDY (TU3M)	4	<b>ZM 003</b>	<b>ZS 247</b>
1.6	1.6	65	07.89-12.93	BDY (XU5M2Z)/BDZ (XU5M)/BDY (XU5M3Z)	4		<b>ZS 232</b>
1.6	1.6	68	07.89-12.93	B2A (XU52C/K)	4	<b>ZM 003</b>	<b>ZS 257</b>
1.6	1.6	69	07.89-12.93	B2A (XU52C/K)	4	<b>ZM 003</b>	<b>ZS 257</b>
1.9	1.9	72	08.89-12.93	DFZ (XU9J1)	4	<b>ZM 001</b>	
1.9 GTI	1.9	88	07.89-12.93	DKZ (XU9JAZ)	4	<b>ZM 001</b>	
1.9 GTI	1.9	88	01.91-12.93	DKZ (XU9JAZ)	4		<b>ZS 247</b>
1.9 GTI 16V	1.9	108	10.90-12.93	DFW (XU9J4Z)	4	<b>ZM 001</b>	<b>ZS 257</b>
1.9 GTI 16V	1.9	116	08.89-07.90	D6C (XU9J4)	4	<b>ZM 001</b>	<b>ZS 257</b>
<b>405 I</b>							
1.6	1.6	55	07.87-06.88	B1E (XU51C)/BAZ (XU5CP)	4	<b>ZM 003</b>	
1.6	1.6	65	07.87-12.92	BDY (XU5M2Z)/BDZ (XU5M) Fgst.Nr.→77119980	4	<b>ZM 003</b>	<b>ZS 257</b>
1.6	1.6	66	10.89-12.92	BDZ (XU5M) Fgst.Nr.→70119980	4	<b>ZM 003</b>	<b>ZS 257</b>
1.9	1.9	70	07.87-12.92	D2C (XU92C)	4	<b>ZM 003</b>	<b>ZS 257</b>
1.9	1.9	80	07.88-12.92	DDZ (XU9M)	4	<b>ZM 003</b>	
1.9	1.9	88	07.88-12.92	DKZ (XU9JAZ)	4	<b>ZM 003</b>	<b>ZS 257</b>
1.9	1.9	93	07.87-12.93		4		<b>ZS 232</b>
1.9 4x4	1.9	80	07.88-12.92	DDZ (XU9M)	4	<b>ZM 003</b>	
1.9 Injection	1.9	77	07.87-12.92	DFZ (XU9J1)	4	<b>ZM 003</b>	
1.9 Sport MI-16	1.9	108	04.88-12.92	DFW (XU9J4Z)	4	<b>ZM 003</b>	
1.9 Sport MI-16	1.9	116	07.87-11.91	D6C (XU9J4)	4	<b>ZM 003</b>	
<b>405 I Break</b>							
1.6	1.6	53	10.88-08.92	B1E (XU51C)	4	<b>ZM 003</b>	
1.6	1.6	55	10.88-08.92	BAZ (XU5CP)	4	<b>ZM 003</b>	
1.6	1.6	65	10.90-08.92	BDY (XU5M2Z)/BDZ (XU5M)/BDY (XU5M3Z)	4		<b>ZS 232</b>
1.6	1.6	65	10.88-09.90	BDY (XU5M2Z)/BDZ (XU5M)/BDY (XU5M3Z)	4		<b>ZS 257</b>
1.6	1.6	66	10.88-08.92	BDZ (XU5M)	4	<b>ZM 003</b>	<b>ZS 257</b>
1.9	1.9	70	10.88-08.92	D2C (XU92C)	4	<b>ZM 003</b>	<b>ZS 257</b>
1.9	1.9	72	05.88-07.92	DFZ (XU9J1)	4	<b>ZM 003</b>	
1.9	1.9	77	10.88-08.92	DFZ (XU9J1)	4	<b>ZM 003</b>	
1.9	1.9	80	10.88-08.92	DDZ (XU9M)	4	<b>ZM 003</b>	
1.9	1.9	88	10.88-08.92	DKZ (XU9JAZ)	4	<b>ZM 003</b>	<b>ZS 257</b>
1.9 4x4	1.9	80	10.88-08.92	DDZ (XU9M)	4	<b>ZM 003</b>	



kW

**PEUGEOT****405 I Break**

1.9 Allrad	1.9	77	09.88–07.92	DFZ (XU9J1)	4	<b>ZM 003</b>	
------------	-----	----	-------------	-------------	---	---------------	--

**405 II**

1.4	1.4	55	08.92–10.95	KDX (TU3MC)	4	<b>ZM 003</b>	<b>ZS 231</b>
-----	-----	----	-------------	-------------	---	---------------	---------------

1.6	1.6	65	08.92–10.95	BFZ (XU5JP)/BDY (XU5M2Z)/BDZ (XU5M)/BDY (XU5M3Z)	4	<b>ZM 003</b>	<b>ZS 232</b>
-----	-----	----	-------------	--	---	---------------	---------------

1.8	1.8	74	08.92–10.95	LFZ (XU7JP)	4	<b>ZM 003</b>	<b>ZS 232</b>
-----	-----	----	-------------	-------------	---	---------------	---------------

2.0	2.0	89	08.92–10.95	RFX (XU10J2)	4	<b>ZM 003</b>	<b>ZS 232</b>
-----	-----	----	-------------	--------------	---	---------------	---------------

2.0 MI-16	2.0	112	08.92–10.95	RFY (XU10J4Z)	4	<b>ZM 026</b>	<b>ZS 232</b>
-----------	-----	-----	-------------	---------------	---	---------------	---------------

2.0 T 16 X4	2.0	144	08.92–10.95	RGZ (XU10J4TE/Z)	4	<b>ZM 026</b>	<b>ZS 232</b>
-------------	-----	-----	-------------	------------------	---	---------------	---------------

2.0 T 16 X4	2.0	144	08.92–10.95	XU10J4TEZ	4	<b>ZM 026</b>	<b>ZS 323</b>
-------------	-----	-----	-------------	-----------	---	---------------	---------------

2.0 X4	2.0	89	08.92–10.95	RFX (XU10J2)	4	<b>ZM 003</b>	<b>ZS 232</b>
--------	-----	----	-------------	--------------	---	---------------	---------------

**405 II Break**

1.4	1.4	55	08.92–10.96	KDX (TU3MC)	4	<b>ZM 003</b>	<b>ZS 231</b>
-----	-----	----	-------------	-------------	---	---------------	---------------

1.6	1.6	65	08.92–10.96	BFZ (XU5JP)/BDY (XU5M2Z)/BDZ (XU5M)/BDY (XU5M3Z)	4	<b>ZM 003</b>	<b>ZS 232</b>
-----	-----	----	-------------	--	---	---------------	---------------

1.8	1.8	74	08.92–10.96	LFZ (XU7JP)	4	<b>ZM 003</b>	<b>ZS 232</b>
-----	-----	----	-------------	-------------	---	---------------	---------------

2.0	2.0	89	08.92–10.96	RFX (XU10J2)	4	<b>ZM 003</b>	<b>ZS 232</b>
-----	-----	----	-------------	--------------	---	---------------	---------------

2.0 4x4	2.0	89	08.92–10.96	RFX (XU10J2)	4	<b>ZM 003</b>	<b>ZS 232</b>
---------	-----	----	-------------	--------------	---	---------------	---------------

2.0 4x4	2.0	144	08.92–12.95	RGZ (XU10J4TE/Z)	4	<b>ZM 026</b>	<b>ZS 232</b>
---------	-----	-----	-------------	------------------	---	---------------	---------------

2.0 4x4	2.0	144	08.92–12.95	XU10J4TEZ	4		<b>ZS 323</b>
---------	-----	-----	-------------	-----------	---	--	---------------

**406**

1.6	1.6	65	11.95–05.04	BFZ (XU5JP)	4		<b>ZS 232</b>
-----	-----	----	-------------	-------------	---	--	---------------

1.8	1.8	66	05.97–05.04		4		<b>ZS 232</b>
-----	-----	----	-------------	--	---	--	---------------

1.8 16V	1.8	81	11.95–10.00	LFY (XU7JP4) Org.Nr.→07608	4		<b>ZS 256</b>
---------	-----	----	-------------	-------------------------------	---	--	---------------

1.8 16V	1.8	81	11.95–10.00	LFY (XU7JP4) Org.Nr.07609→	4		<b>ZS 349</b>
---------	-----	----	-------------	-------------------------------	---	--	---------------

1.8 16V	1.7	85	10.00–05.04	6FZ (EW7J4)	4		<b>ZS 348</b>
---------	-----	----	-------------	-------------	---	--	---------------

2.0 16V	2.0	97	11.95–05.04	RFV (XU10J4R)	4		<b>ZS 232</b>
---------	-----	----	-------------	---------------	---	--	---------------

2.0 16V	2.0	97	09.97–05.04	RFV (XU10J4R)	4		<b>ZS 349</b>
---------	-----	----	-------------	---------------	---	--	---------------

2.0 16V	2.0	97	11.95–09.97	RFV (XU10J4R) Org.Nr.→7608	4		<b>ZS 256</b>
---------	-----	----	-------------	-------------------------------	---	--	---------------

2.0 16V	2.0	99	01.99–08.00	RFR (DEW10J4)	4		<b>ZS 348</b>
---------	-----	----	-------------	---------------	---	--	---------------

2.0 16V	2.0	100	08.00–05.04	RFN (EW10J4)	4		<b>ZS 348</b>
---------	-----	-----	-------------	--------------	---	--	---------------

2.0 Turbo	2.0	108	04.96–05.04	RGX (XU10J2TE)	4		<b>ZS 232</b>
-----------	-----	-----	-------------	----------------	---	--	---------------

2.2	2.2	116	07.00–05.04	3FZ (EW12J4)	4		<b>ZS 351</b>
-----	-----	-----	-------------	--------------	---	--	---------------

3.0 24V	2.9	140	10.96–12.99	ES9J4/L3	6		<b>ZS 343</b>
---------	-----	-----	-------------	----------	---	--	---------------

3.0 V6	2.9	152	03.00–05.04	XFX (ES9J4S)	6		<b>ZS 347</b>
--------	-----	-----	-------------	--------------	---	--	---------------

**406 Break**

1.8	1.8	66	05.97–10.04	LFX (XU7JB)	4		<b>ZS 232</b>
-----	-----	----	-------------	-------------	---	--	---------------

1.8 16V	1.8	81	10.96–10.00	LFY (XU7JP4) Org.Nr.→07608	4		<b>ZS 256</b>
---------	-----	----	-------------	-------------------------------	---	--	---------------

1.8 16V	1.8	81	10.96–10.00	LFY (XU7JP4) Org.Nr.07609→	4		<b>ZS 349</b>
---------	-----	----	-------------	-------------------------------	---	--	---------------

1.8 16V	1.7	85	10.00–10.04	6FZ (EW7J4)	4		<b>ZS 348</b>
---------	-----	----	-------------	-------------	---	--	---------------

2.0 16V	2.0	97	10.96–09.97	RFV (XU10J4R) Org.Nr.→7608	4		<b>ZS 256</b>
---------	-----	----	-------------	-------------------------------	---	--	---------------

2.0 16V	2.0	97	10.96–10.04	RFV (XU10J4R)	4		<b>ZS 232</b>
---------	-----	----	-------------	---------------	---	--	---------------

2.0 16V	2.0	97	09.97–10.04	RFV (XU10J4R)	4		<b>ZS 349</b>
---------	-----	----	-------------	---------------	---	--	---------------

2.0 16V	2.0	99	04.99–10.00	RFR (DEW10J4)	4		<b>ZS 348</b>
---------	-----	----	-------------	---------------	---	--	---------------

2.0 16V	2.0	100	10.00–10.04	RFN (EW10J4)	4		<b>ZS 348</b>
---------	-----	-----	-------------	--------------	---	--	---------------

2.0 Turbo	2.0	108	10.96–10.04	RGX (XU10J2TE)	4		<b>ZS 232</b>
-----------	-----	-----	-------------	----------------	---	--	---------------

2.2	2.2	116	07.00–10.04	3FZ (EW12J4)	4		<b>ZS 351</b>
-----	-----	-----	-------------	--------------	---	--	---------------

3.0 24V	2.9	140	10.96–12.99	ES9J4/L3	6		<b>ZS 343</b>
---------	-----	-----	-------------	----------	---	--	---------------

3.0 V6	2.9	152	03.00–10.04	XFX (ES9J4S)	6		<b>ZS 347</b>
--------	-----	-----	-------------	--------------	---	--	---------------

**406 Coupe**

2.0 16V	2.0	97	03.97–09.97	RFV (XU10J4R) Org.Nr.→7608	4		<b>ZS 256</b>
---------	-----	----	-------------	-------------------------------	---	--	---------------

2.0 16V	2.0	97	03.97–12.04	RFV (XU10J4R)	4		<b>ZS 232</b>
---------	-----	----	-------------	---------------	---	--	---------------

2.0 16V	2.0	97	03.97–12.04	RFV (XU10J4R)	4		<b>ZS 349</b>
---------	-----	----	-------------	---------------	---	--	---------------

2.0 16V	2.0	99	04.99–10.00	RFR (DEW10J4)	4		<b>ZS 348</b>
---------	-----	----	-------------	---------------	---	--	---------------

2.0 16V	2.0	100	10.00–12.04	RFN (EW10J4)	4		<b>ZS 348</b>
---------	-----	-----	-------------	--------------	---	--	---------------





kW

**PEUGEOT**

<b>406 Coupe</b>							
2.2	2.2	116	03.02–12.04	3FZ (EW12J4)	4		<b>ZS 351</b>
3.0 V6	2.9	152	03.00–12.04	XFX (ES9J4S)	6		<b>ZS 347</b>
3.0 V6 24V	2.9	140	03.97–12.99	ES9J4/L3	6		<b>ZS 343</b>
<b>407</b>							
1.8	1.7	85	05.04–	6FZ (EW7J4)	4		<b>ZS 348</b>
1.8	1.7	85	05.04–	6FZ (EW7J4)	4		<b>ZS 351</b>
1.8 16V	1.7	92	01.06–	6FY (EW7A)	4		<b>ZS 351</b>
2.0	2.0	100	05.04–	RFN (EW10J4)	4		<b>ZS 348</b>
2.0 16V	2.0	103	01.06–	RFJ (EW10A)	4		<b>ZS 352</b>
2.2	2.2	116	05.04–	3FZ (EW12J4)	4		<b>ZS 351</b>
2.2 16V	2.2	120	09.05–	3FY (EW12J4)	4		<b>ZS 351</b>
2.2 16V	2.2	120	09.05–	3FY (EW12J4)	4		<b>ZS 353</b>
3.0	2.9	155	05.04–	XFV (ES9A)	6		<b>ZS 347</b>
<b>407 Coupe</b>							
2.2 16V	2.2	120	10.05–	3FY (EW12J4)	4		<b>ZS 351</b>
2.2 16V	2.2	120	10.05–	3FY (EW12J4)	4		<b>ZS 353</b>
3.0 V6	2.9	155	10.05–	XFV (ES9A)	6		<b>ZS 347</b>
<b>407 SW</b>							
1.8	1.7	85	05.04–	6FZ (EW7J4)	4		<b>ZS 348</b>
1.8	1.7	85	05.04–	6FZ (EW7J4)	4		<b>ZS 351</b>
1.8 16V	1.7	92	01.06–	6FY (EW7A)	4		<b>ZS 351</b>
2.0	2.0	100	05.04–	RFN (EW10J4)	4		<b>ZS 348</b>
2.0 16V	2.0	103	01.06–	RFJ (EW10A)	4		<b>ZS 352</b>
2.2	2.2	116	05.04–	3FZ (EW12J4)	4		<b>ZS 351</b>
2.2 16V	2.2	120	09.05–	3FY (EW12J4)	4		<b>ZS 351</b>
2.2 16V	2.2	120	09.05–	3FY (EW12J4)	4		<b>ZS 353</b>
3.0	2.9	155	05.04–	XFV (ES9A)	6		<b>ZS 347</b>
<b>504</b>							
2.0	2.0	71	03.71–06.86	106 (XN1)	4	<b>ZM 001</b>	<b>ZS 106</b>
<b>505</b>							
1.8	1.8	55	06.81–10.85	105 (XM7)	4	<b>ZM 001</b>	<b>ZS 110</b>
1.8	1.8	60	01.82–10.85	105 (XM7)	4	<b>ZM 001</b>	<b>ZS 110</b>
1.8	1.8	62	09.85–10.86	XM7A	4	<b>ZM 001</b>	
2.0	2.0	71	11.80–12.85	106 (XN1)	4	<b>ZM 001</b>	<b>ZS 110</b>
2.0	2.0	72	09.85–09.91	106E (XN1A)	4	<b>ZM 001</b>	<b>ZS 110</b>
2.0 Ti,STI	2.0	81	08.79–10.86	829 (ZEJ)	4	<b>ZM 001</b>	
2.2	2.2	84	03.86–12.93	851X (ZDJL)	4	<b>ZM 001</b>	
2.2	2.2	85	05.81–10.84	851 (ZDJ)	4	<b>ZM 001</b>	
2.2 GTI	2.2	90	08.83–12.93	851B (ZDJL)	4	<b>ZM 001</b>	
2.2 Turbo Injection	2.2	114	03.84–10.88	176B (N9TE)	4	<b>ZM 001</b>	
2.2 Turbo Injection	2.2	128	06.87–12.88	176W (N9TEA)	4	<b>ZM 001</b>	
2.8 GTI V6	2.8	105	06.86–12.93	154X (ZN3J)	6	<b>ZM 015</b>	<b>ZS 119</b>
<b>505 Break</b>							
2.0	2.0	69	08.83–12.85	106 (XN1)	4	<b>ZM 001</b>	<b>ZS 110</b>
2.0	2.0	72	09.85–11.87	106E (XN1A)	4	<b>ZM 001</b>	
<b>508</b>							
1.6 VTi	1.6	85	11.10–		4		<b>ZSE 143</b>
1.6 VTi	1.6	88	11.10–	5FS (EP6C)	4		<b>ZSE 143</b>
<b>508 SW</b>							
1.6 VTi	1.6	88	11.10–	5FS (EP6C)	4		<b>ZSE 143</b>
<b>605</b>							
2.0	2.0	79	02.90–09.99		4	<b>ZM 003</b>	<b>ZS 258</b>
2.0	2.0	89	10.90–06.93	RFZ (XU10J2Z)	4	<b>ZM 026</b>	
2.0	2.0	89	06.89–09.90	RFZ (XU10J2Z)	4	<b>ZM 001</b>	<b>ZS 249</b>
2.0	2.0	89	10.90–09.99	RFZ (XU10J2Z)	4		<b>ZS 232</b>
2.0 16V	2.0	97	07.94–09.99	RFV (XU10J4R) Org.Nr.→7608	4		<b>ZS 256</b>
2.0 16V	2.0	97	09.97–09.99	RFV (XU10J4R) Org.Nr.07609→	4		<b>ZS 349</b>
2.0 Turbo	2.0	104	07.92–09.99	RGY (XU10J2TE)	4	<b>ZM 026</b>	<b>ZS 232</b>
2.0 Turbo	2.0	108	07.91–09.99	RGX (XU10J2TE)	4	<b>ZM 026</b>	<b>ZS 232</b>



kW



## PEUGEOT

<b>605</b>							
3.0	3.0	123	10.89–09.99	UFZ (ZPJ)	6	<b>ZM 015</b>	
3.0 SV 24	3.0	147	08.89–09.99	UKZ (ZPJ4/Z)	6	<b>ZM 015</b>	
3.0 V6	2.9	140	04.97–09.99	XFZ (ES9J4)	6	<b>ZM 015</b>	
3.0 V6	2.9	140	04.97–09.99	ES9J4/L3	6		<b>ZS 343</b>
<b>607</b>							
2.0	2.0	100	05.00–	RFN (EW10J4)	4		<b>ZS 348</b>
2.2 16V	2.2	116	05.00–	3FZ (EW12J4)	4		<b>ZS 351</b>
2.2 16V	2.2	116	10.04–	3FZ (EW12J4)	4		<b>ZS 353</b>
2.2 16V	2.2	120	09.05–	3FY (EW12J4)	4		<b>ZS 351</b>
2.2 16V	2.2	120	09.05–	3FY (EW12J4)	4		<b>ZS 353</b>
3.0 V6 24V	2.9	152	02.00–	XFX (ES9J4S)	6		<b>ZS 347</b>
3.0 V6 24V	2.9	155	10.04–	XFX (ES9A)	6		<b>ZS 347</b>
<b>806</b>							
1.8	1.8	73	07.95–08.02	LFW (XU7JP)	4		<b>ZS 232</b>
2.0	2.0	89	06.94–08.02	RFU (XU10J2)	4		<b>ZS 232</b>
2.0 16V	2.0	97	05.98–09.00	RFV (XU10J4R)	4	<b>ZM 026</b>	
2.0 16V	2.0	97	10.98–09.00	RFV (XU10J4R)	4		<b>ZS 349</b>
2.0 16V	2.0	100	09.00–05.02	RFN (EW10J4)	4		<b>ZS 348</b>
2.0 Turbo	2.0	108	06.94–08.02	RGX (XU10J2TE)	4	<b>ZM 026</b>	<b>ZS 232</b>
<b>807</b>							
2.0	2.0	100	06.02–	RFN (EW10J4)	4		<b>ZS 348</b>
2.0 16V	2.0	103	02.06–	RFJ (EW10A)	4		<b>ZS 352</b>
2.2	2.2	116	06.02–	3FZ (EW12J4)	4		<b>ZS 351</b>
3.0 V6	2.9	150	06.02–	XFX (ES9J4S)	6		<b>ZS 347</b>
<b>1007</b>							
1.4	1.4	54	04.05–	KFV (TU3JP)	4		<b>ZSE 047</b>
1.4	1.4	54	09.05–	KFV (TU3JP)	4		<b>ZSE 048</b>
1.6 16V	1.6	80	04.05–	NFU (TU5JP4)	4		<b>ZSE 045</b>
<b>3008</b>							
1.6 VTi	1.6	88	06.09–	5FS (EP6C)/EP6	4		<b>ZSE 143</b>
<b>5008</b>							
1.6 16V	1.6	88	09.09–	5FS (EP6C)/EP6	4		<b>ZSE 143</b>
							
<b>BIPPER</b>							
1.4	1.4	54	02.08–	KFV (TU3A)	4		<b>ZSE 048</b>
<b>BOXER</b>							
2.0 i	2.0	80	03.94–04.02	RFW (XU10J2)	4		<b>ZS 232</b>
<b>EXPERT</b>							
1.8	1.8	74	10.96–09.00	LFZ (XU7JP)	4		<b>ZS 232</b>
<b>EXPERT</b>							
2.0	2.0	100	07.00–	RFN (EW10J4)	4		<b>ZS 348</b>
<b>J5</b>							
2.0	2.0	55	09.81–09.90	170B (XN1T)	4	<b>ZM 001</b>	<b>ZS 110</b>
2.0	2.0	58	01.83–09.90	170 (XN1T)	4	<b>ZM 001</b>	
2.0	2.0	62	10.90–02.94	170D (XN1TACP)	4	<b>ZM 001</b>	
<b>J9</b>							
1.6	1.6	44	03.80–06.87	XC7P	4	<b>ZM 001</b>	
2.0	2.0	57	03.80–06.87	XN1P	4	<b>ZM 001</b>	
<b>PARTNER</b>							
1.1	1.1	44	06.96–	HDZ (TU1M)/HFX (TU1JP)	4		<b>ZS 232</b>
1.4	1.4	55	06.96–08.02	KFX (TU3JP)	4		<b>ZS 381</b>
1.4	1.4	55	06.96–	KFX (TU3JP)/TU32/KFW (TU3JP)	4		<b>ZS 232</b>
1.4	1.4	55	09.00–	KFX (TU3JP)/TU32/KFW (TU3JP)	4		<b>ZSE 047</b>
1.4	1.4	55	09.05–	KFX (TU3JP)/TU32/KFW (TU3JP)	4		<b>ZSE 048</b>
1.6 16V	1.6	80	07.01–	NFU (TU5JP4)	4		<b>ZSE 045</b>
1.8	1.8	66	05.97–	LFX (XU7JB)	4		<b>ZS 232</b>



kW



**PININFARINA**

<b>SPIDEREUROPA</b>							
2000	2.0	76	11.84–11.85	132 C3.031	4		<b>ZS 106</b>
2000	2.0	76	11.84–11.85	132 C3.031	4		<b>ZS 115</b>
2000 Volumex	2.0	99	06.83–11.85	232R14	4		<b>ZS 106</b>
2000 Volumex	2.0	99	06.83–11.85	232R14	4		<b>ZS 115</b>

**PLYMOUTH**

<b>VOYAGER</b>							
3.3 i	3.3	116	01.95–03.01	EGM	6		<b>ZS 405</b>
3.3 LE	3.3	112	10.89–09.90	EGA	6		<b>ZS 405</b>
3.8 i	3.8	122	01.95–03.01	EGH	6		<b>ZS 405</b>
3.8 i	3.8	131	01.95–03.01	EGH	6		<b>ZS 405</b>
3.8 i AWD	3.8	122	01.95–03.01	EGH	6		<b>ZS 405</b>
3.8 i AWD	3.8	131	01.95–03.01	EGH	6		<b>ZS 405</b>

**PORSCHE**

<b>911 (964)</b>							
3.6 Carrera	3.6	184	07.89–09.93	M 64.01/M 64.02	6		<b>ZM 015</b>
3.6 Carrera 4	3.6	184	12.88–09.93	M 64.01	6		<b>ZM 015</b>
<b>911 (993)</b>							
3.6 Carrera	3.6	200	10.93–08.95	M 64.05/M 64.07/M 64.08/M 64.06	6		<b>ZM 026 ZS 357</b>
3.6 Carrera	3.6	210	08.95–09.97	M 64.24/M 64.22/M 64.21/M 64.23	6		<b>ZM 026 ZS 357</b>
3.6 Carrera 4	3.6	200	07.94–08.95	M 64.05/M 64.07	6		<b>ZM 026 ZS 357</b>
3.6 Carrera 4	3.6	210	08.95–09.97	M 64.21/M 64.23	6		<b>ZM 026 ZS 357</b>
3.8 Carrera	3.7	210	06.95–09.97	M 64.05S/M 64.06S	6		<b>ZS 357</b>
3.8 Carrera 4	3.7	210	06.95–09.97	M 64.05S/M 64.06S	6		<b>ZS 357</b>
3.8 Carrera RS	3.8	221	06.95–09.97	M 64.20	6		<b>ZM 026 ZS 357</b>
3.8 Carrera RS 4	3.8	221	08.95–09.97	M 64.20	6		<b>ZM 026 ZS 357</b>
<b>911 Cabriolet (993)</b>							
3.6 Carrera	3.6	200	07.94–08.95	M 64.05/M 64.07/M 64.08/M 64.06	6		<b>ZM 026 ZS 357</b>
3.6 Carrera	3.6	210	08.95–09.97	M 64.24/M 64.22/M 64.21/M 64.23	6		<b>ZM 026 ZS 357</b>
3.6 Carrera 4	3.6	200	07.94–08.95	M 64.05/M 64.07	6		<b>ZM 026 ZS 357</b>
3.6 Carrera 4	3.6	210	08.95–09.97	M 64.21/M 64.23	6		<b>ZM 026 ZS 357</b>
3.8 Carrera	3.7	210	06.95–09.97	M 64.05S/M 64.06S	6		<b>ZM 026 ZS 357</b>
3.8 Carrera 4	3.7	210	06.95–08.95	M 64.05S/M 64.06S	6		<b>ZS 357</b>
3.8 Carrera RS	3.8	221	08.95–09.97	M 64.21S	6		<b>ZM 026 ZS 357</b>
3.8 Carrera RS 4	3.8	221	08.95–09.97	M 64.21S	6		<b>ZM 026 ZS 357</b>
<b>911 Targa (993)</b>							
3.6 Carrera	3.6	210	08.95–09.97	M 64.24/M 64.22/M 64.21/M 64.23	6		<b>ZM 026 ZS 357</b>
3.7 Carrera	3.8	221	05.96–09.97	M 64.20	6		<b>ZM 026 ZS 357</b>
<b>911 (996)</b>							
3.4 Carrera	3.4	221	09.97–09.01	M 96.01/M 96.04	6		<b>ZS 031 ZLE 278</b>
3.4 Carrera 4	3.4	221	09.97–09.01	M 96.01/M 96.04	6		<b>ZS 031 ZLE 278</b>
3.6 Carrera	3.6	235	10.01–08.05	M 96.03	6		<b>ZS 036 ZLE 255</b>
3.6 Carrera 4	3.6	235	10.01–08.05	M 96.03	6		<b>ZS 031 ZLE 278</b>
3.6 Carrera 4S	3.6	254	02.03–07.04	M 96.03	6		<b>ZS 036 ZLE 255</b>
3.6 Carrera S	3.6	254	02.03–07.04	M 96.03	6		<b>ZS 036 ZLE 255</b>
3.6 GT2	3.6	340	04.01–08.05	M 96.70	6		<b>ZS 036 ZLE 255</b>
3.6 GT2	3.6	355	10.03–08.05	M 96.70	6		<b>ZS 036 ZLE 255</b>
3.6 GT3	3.6	265	03.99–08.03	M 96.76	6		<b>ZS 036 ZLE 255</b>
3.6 GT3	3.6	280	03.03–08.05	M 96.79	6		<b>ZS 036 ZLE 255</b>
3.6 S	3.6	331	08.04–08.05	M 96.70	6		<b>ZS 036 ZLE 255</b>
3.6 Turbo 4	3.6	309	06.00–08.05	M 96.70	6		<b>ZS 036 ZLE 255</b>
3.6 Turbo 4S	3.6	331	02.03–08.05	M 96.70	6		<b>ZS 036 ZLE 255</b>
<b>911 Cabriolet (996)</b>							
3.4 Carrera	3.4	221	02.98–09.01	M 96.01/M 96.04	6		<b>ZS 031 ZLE 278</b>
3.4 Carrera 4	3.4	221	02.98–09.01	M 96.02/M 96.04	6		<b>ZS 036 ZLE 255</b>
3.6 Carrera	3.6	235	10.01–08.05	M 96.03	6		<b>ZS 036 ZLE 255</b>
3.6 Carrera 4	3.6	235	10.01–08.05	M 96.03	6		<b>ZS 036 ZLE 255</b>
3.6 Carrera 4S	3.6	254	06.02–07.04	M 96.03	6		<b>ZS 036 ZLE 255</b>
3.6 Carrera S	3.6	254	06.02–07.04	M 96.03	6		<b>ZS 036 ZLE 255</b>
3.6 S	3.6	331	08.04–08.05	M 96.70	6		<b>ZS 036 ZLE 255</b>



kW

**PORSCHE****911 Cabriolet (996)**

3.6 Turbo 4	3.6	309	10.03–08.05	M 96.70	6	ZS 036	ZLE 255
3.6 Turbo 4S	3.6	331	10.03–08.05	M 96.70	6	ZS 036	ZLE 255

**911 Targa (996)**

3.6	3.6	235	12.01–08.05	M 96.03	6	ZS 036	ZLE 255
-----	-----	-----	-------------	---------	---	--------	---------

**911 (997)**

3.6 Carrera	3.6	239	07.04–	M 96.05	6	ZS 031	ZLE 278
3.6 Carrera	3.6	254	06.08–	MA1.02	6	ZSE 052	GS 28
3.6 Carrera 4	3.6	254	06.08–	MA1.02	6	ZSE 052	GS 28
3.6 GT 3	3.6	305	03.06–	M 97.76	6	ZS 031	ZLE 278
3.6 GT2 RS	3.6	456	05.10–	M 97.70	6	ZS 031	ZLE 278
3.6 Turbo	3.6	353	03.06–	M 97.70	6	ZS 031	ZLE 278
3.8 Carrera 4GTS	3.8	300	06.09–	MA1.01	6	ZSE 052	GS 28
3.8 Carrera 4S	3.8	261	07.04–	M 97.01	6	ZS 031	ZLE 278
3.8 Carrera 4S	3.8	283	06.08–	MA1.01	6	ZSE 052	GS 28
3.8 Carrera GTS	3.8	300	06.09–	MA1.01	6	ZSE 052	GS 28
3.8 Carrera S	3.8	261	07.04–	M 97.01	6	ZS 031	ZLE 278
3.8 Carrera S	3.8	283	06.08–	MA1.01	6	ZSE 052	GS 28

**911 Cabriolet (997)**

3.6 Carrera	3.6	254	06.08–	MA1.02	6	ZSE 052	GS 28
3.6 Carrera 4	3.6	254	06.08–	MA1.02	6	ZSE 052	GS 28
3.6 Turbo	3.6	353	09.07–	M 97.70	6	ZS 031	ZLE 278
3.8 Carrera 4GTS	3.8	300	06.09–	MA1.01	6	ZSE 052	GS 28
3.8 Carrera 4S	3.8	283	06.08–	MA1.01	6	ZSE 052	GS 28
3.8 Carrera GTS	3.8	300	06.09–	MA1.01	6	ZSE 052	GS 28
3.8 Carrera S	3.8	261	04.05–	M 97.01	6	ZS 036	ZLE 255
3.8 Carrera S	3.8	283	06.08–	MA1.01	6	ZSE 052	GS 28

**911 Targa (997)**

3.6 Carrera 4	3.6	254	10.08–	MA1.02	6	ZSE 052	GS 28
3.8 Carrera 4S	3.8	283	10.08–	MA1.01	6	ZSE 052	GS 28

**924**

2.0	2.0	92	11.75–08.89	XJ	4	ZS 115	
-----	-----	----	-------------	----	---	--------	--

**928**

4.6 S	4.7	228	08.83–07.86	M 28.22/M 28.21	8	ZM 015	
4.9 S	5.0	212	09.85–05.94	M 28.46/M 28.45	8	ZM 015	
4.9 S,S4	5.0	235	08.86–07.91	M 28.41/M 28.42	8	ZM 015	
4.9 S,S4	5.0	235	08.89–07.91	M 28.41/M 28.42	8	ZS 122	
5.0 GT	5.0	243	01.89–07.91	M 28.47	8	ZM 015	ZS 122
5.0 S4 KAT	5.0	235	08.89–07.91	M 28.41/M 28.42	8	ZM 015	ZS 122
5.4 GTS	5.4	257	08.91–11.95	M 28.49/M 28.50	8	ZM 015	ZS 122

**944**

2.5 S	2.5	140	08.86–07.88	M 44.40	4	ZM 015	
2.7	2.7	121	11.88–08.89	M 44.12/M 44.11	4	ZM 015	
3.0 S2	3.0	155	12.88–07.91	M 44.41	4	ZM 015	

**959**

2.8	2.9	330	01.86–04.91	959.50	6	ZS 298	
-----	-----	-----	-------------	--------	---	--------	--

**BOXSTER (986)**

2.5	2.5	150	09.96–08.99	M 96.20	6	ZS 031	ZLE 278
2.7	2.7	162	08.99–07.02	M 96.22	6	ZS 036	ZLE 255
2.7	2.7	168	07.02–10.04	M 96.23	6	ZS 036	ZLE 255
S 3.2	3.2	185	08.99–07.02	M 96.21	6	ZS 036	ZLE 255
S 3.2	3.2	191	07.02–10.04	M 96.24	6	ZS 036	ZLE 255
S 3.2	3.2	196	01.04–10.04	M 96.24	6	ZS 036	ZLE 255

**BOXSTER (987)**

2.7	2.7	176	11.04–	M 96.25	6	ZS 031	ZLE 278
2.7	2.7	180	07.06–	M 97.20	6	ZS 031	ZLE 278
2.9	2.9	188	06.09–	MA1.20	6	ZSE 052	GS 28
S 3.2	3.2	206	11.04–	M 96.26	6	ZS 031	ZLE 278
S 3.4	3.4	217	07.06–	M 97.21	6	ZS 031	ZLE 278
S 3.4	3.4	228	06.09–	MA1.21	6	ZSE 052	GS 28
Spyder 3.4	3.4	235	06.10–	MA1.21	6	ZSE 052	GS 28



kW



**PORSCHE**

**CARRERA GT**

5.7	5.7	450	07.03–	M 80.01	10		<b>ZSE 054</b>	<b>GS 28</b>
-----	-----	-----	--------	---------	----	--	----------------	--------------

**CAYENNE (955)**

3.2	3.2	177	08.03–	M02.2Y	6		<b>ZSE 044</b>	
3.2	3.2	184	10.03–	M02.2Y	6		<b>ZSE 044</b>	
S 4.5	4.5	250	09.02–	M 48.00	8		<b>ZSE 012</b>	<b>GS 28</b>
S 4.8	4.8	283	02.07–	M 48.01	8		<b>ZSE 042</b>	<b>GS 28</b>
Turbo 4.5	4.5	331	09.02–	M 48.50	8		<b>ZSE 012</b>	<b>GS 28</b>
Turbo S 4.8	4.8	368	02.07–	M 48.51	8		<b>ZSE 042</b>	<b>GS 28</b>

**CAYMAN (987)**

2.7	2.7	180	07.06–	M 97.20	6		<b>ZS 031</b>	<b>ZLE 278</b>
2.9	2.9	195	02.09–	MA1.20	6		<b>ZSE 052</b>	<b>GS 28</b>
S 3,4 Sport	3.4	223	08.08–	M 97.22	6		<b>ZS 036</b>	<b>ZLE 255</b>
S 3.4	3.4	217	11.05–	M 97.21	6		<b>ZS 036</b>	<b>ZLE 255</b>
S 3.4	3.4	235	02.09–	MA1.21	6		<b>ZSE 052</b>	<b>GS 28</b>

**PANAMERA**

3.0 S Hybrid	3.0	245	03.11–	MCG.FA/MCG.EA	6		<b>ZSE 032</b>	
3.6	3.6	220	05.10–	M 46.20	6		<b>ZSE 042</b>	<b>GS 28</b>
3.6 4	3.6	220	05.10–	M 46.40	6		<b>ZSE 042</b>	<b>GS 28</b>
4.8 4S	4.8	294	09.09–	M 48.40	8		<b>ZSE 042</b>	<b>GS 28</b>
4.8 S	4.8	294	09.09–	M 48.20	8		<b>ZSE 042</b>	<b>GS 28</b>
4.8 Turbo	4.8	368	09.09–	M 48.70	8		<b>ZSE 042</b>	<b>GS 28</b>

**PROTON**

**EXORA**

1.6	1.6	93	04.09–		4		<b>ZS 438</b>	
-----	-----	----	--------	--	---	--	---------------	--

**PERSONA**

1.6	1.6	82	03.08–	4 G 92/S4PH	4		<b>ZS 438</b>	
-----	-----	----	--------	-------------	---	--	---------------	--

**PUCH**

**G-MODELL (W 463)**

G 320	3.2	155	09.94–12.97	M 104.996	6		<b>ZS 340</b>	<b>ZLE 234</b>
G 55 AMG	5.4	260	04.99–	M 113.982	8		<b>ZS 297</b>	

**RENAULT**

**AVANTIME**

2.0 16V Turbo	2.0	120	11.01–05.03	F4R 760/F4R 761	4		<b>ZS 052</b> <sup>282</sup>	<b>GS 29</b>
3.0 V6	2.9	152	09.01–05.03	L7X 720/L7X 721	6		<b>ZS 347</b>	

**CLIO Grandtour**

1.2 16V	1.1	55	02.08–05.08	D4F 740	4		<b>ZS 375</b>	
1.2 16V	1.1	55	06.08–	D4F 740	4		<b>ZS 325</b>	
1.2 16V	1.1	58	02.08–05.08	D4F 764	4		<b>ZS 375</b>	
1.2 16V	1.1	58	06.08–	D4F 764	4		<b>ZS 325</b>	
1.2 16V	1.1	74	02.08–05.08	D4F 784	4		<b>ZS 375</b>	
1.2 16V	1.1	74	06.08–	D4F 784	4		<b>ZS 325</b>	
1.2 16V	1.1	74	02.08–	D4F 784	4		<b>ZS 354</b>	
1.2 16V Hi-Flex	1.1	55	07.08–	D4F 740	4		<b>ZS 325</b> <sup>202</sup>	
1.2 16V Hi-Flex	1.1	55	07.08–	D4F 740	4		<b>ZS 375</b> <sup>202</sup>	
1.4 16V	1.4	72	02.10–	K4J 780	4		<b>ZS 052</b> <sup>282</sup>	<b>GS 29</b>
1.6 16V	1.6	82	02.08–	K4M 800/K4M 801	4		<b>ZS 052</b> <sup>282</sup>	<b>GS 29</b>
1.6 16V	1.6	94	11.08–	K4M 862	4		<b>ZS 052</b> <sup>282</sup>	<b>GS 29</b>

**CLIO I**

1.1	1.1	34	01.91–09.98	C1E 700	4		<b>ZS 106</b>	
1.4	1.4	59	01.91–09.98	E7J 710 /E7J 711	4		<b>ZS 251</b> <sup>202</sup>	
1.4	1.4	59	01.91–09.98	E7J 710 /E7J 711	4		<b>ZS 316</b> <sup>202</sup>	
1.2	1.1	40	01.96–09.98	D7F 730	4		<b>ZS 345</b>	
1.2	1.2	40	01.91–01.96	E7F 706	4		<b>ZS 251</b> <sup>202</sup>	
1.2	1.2	40	01.91–01.96	E7F 706	4		<b>ZS 316</b> <sup>202</sup>	
1.2	1.2	40	04.96–12.96	C3G 720	4		<b>ZS 250</b>	
1.2	1.1	43	01.96–09.98	D7F 730	4		<b>ZS 345</b>	
1.2	1.2	43	05.90–09.98	E7F 750/E7F 700/E7F 708	4		<b>ZS 251</b> <sup>202</sup>	



kW



## RENAULT

RENAULT							
<b>CLIO I</b>							
1.2	1.2	43	05.90-09.98	E7F 750/E7F 700/E7F 708	4	ZS 316 <sup>202</sup>	
1.2	1.2	44	05.90-03.96	E5F 710	4	ZS 251	
1.4	1.4	55	01.91-09.98	E7J 756/E7J 757	4	ZS 251 <sup>202</sup>	
1.4	1.4	55	01.91-09.98	E7J 756/E7J 757	4	ZS 316 <sup>202</sup>	
1.4	1.4	58	01.91-09.98	E7J 719 /E7J 601 /E7J 718/E7J 754	4	ZS 251 <sup>202</sup>	
1.4	1.4	58	01.91-09.98	E7J 719 /E7J 601 /E7J 718/E7J 754	4	ZS 316 <sup>202</sup>	
1.8	1.8	65	01.91-09.98	F3P 710 /F3P 714	4	ZS 251 <sup>202</sup>	
1.8	1.8	65	01.91-09.98	F3P 710 /F3P 714	4	ZS 316 <sup>202</sup>	
1.8	1.8	66	08.90-04.96	F3P 755	4	ZS 251 <sup>202</sup>	
1.8	1.8	66	08.90-04.96	F3P 755	4	ZS 316 <sup>202</sup>	
1.8	1.8	66	08.94-09.98	F3P 755 /F3P 754	4	ZS 251 <sup>202</sup>	
1.8	1.8	66	08.94-09.98	F3P 755 /F3P 754	4	ZS 316 <sup>202</sup>	
1.8 Rsi	1.8	79	08.95-09.98	F3P 758	4	ZS 251 <sup>202</sup>	
1.8 Rsi	1.8	79	08.95-09.98	F3P 758	4	ZS 316 <sup>202</sup>	
1.8 Rsi	1.8	80	01.93-08.95	F3P 712	4	ZS 251 <sup>202</sup>	
1.8 Rsi	1.8	80	01.93-08.95	F3P 712	4	ZS 316 <sup>202</sup>	
Williams	2.0	108	01.94-09.98	F7R 700	4	ZS 251 <sup>202</sup>	
Williams	2.0	108	01.94-09.98	F7R 700	4	ZS 316 <sup>202</sup>	
<b>CLIO II</b>							
1.2	1.1	43	09.98-	D7F 766/D7F 720/D7F 764/D7F 726/ D7F 746	4	ZS 345	
1.2	1.1	43	09.98-	D7F 766/D7F 720/D7F 764/D7F 726/ D7F 746	4	ZS 354	
1.2	1.1	44	03.99-05.01	D7F 722	4	ZS 354	
1.4	1.4	55	09.98-03.01	E7J.6.34 , E7J.6.35	4	ZS 052 <sup>282</sup>	GS 29
1.4	1.4	55	09.98-05.05	E7J 780	4	ZS 242 <sup>120</sup>	
1.4	1.4	55	09.98-05.05	E7J 780	4	ZS 243 <sup>121</sup>	
1.4	1.4	55	09.98-05.05	E7J 780	4	ZS 354	
1.4 16V	1.4	70	10.99-08.00	K4J 712/K4J 713	4	ZS 052 <sup>282</sup>	GS 29
1.4 16V	1.4	72	08.00-	K4J 712/K4J 711/K4J 710/K4J 713	4	ZS 052 <sup>282</sup>	GS 29
1.6	1.6	66	09.98-03.01	K7M 744/K7M 745	4	ZS 052 <sup>282</sup>	GS 29
1.6	1.6	66	09.98-05.05	K7M 744/K7M 745	4	ZS 242 <sup>120</sup>	
1.6	1.6	66	09.98-05.05	K7M 744/K7M 745	4	ZS 243 <sup>121</sup>	
1.6	1.6	66	09.98-05.05	K7M 744/K7M 745	4	ZS 354	
1.6 16V	1.6	79	09.98-	K4M 743/K4M 748/K4M 740/K4M 744/ K4M 742/K4M 708/K4M 745	4	ZS 052 <sup>282</sup>	GS 29
2.0 16V Sport	2.0	124	02.00-	F4R 730	4	ZS 052 <sup>282</sup>	GS 29
2.0 16V Sport	2.0	124	04.01-	F4R 730	4	ZS 345	
2.0 16V Sport	2.0	124	02.00-	F4R 730	4	ZS 354	
2.0 16V Sport	2.0	132	01.04-05.05	F4R 738	4	ZS 345	
2.0 16V Sport	2.0	132	01.04-	F4R 738	4	ZS 052 <sup>282</sup>	GS 29
3.0 V6 Sport	2.9	187	12.02-	L7X 762	6	ZS 347	
<b>CLIO III</b>							
1.2 16V	1.1	48	06.05-05.08	D4F 740	4	ZS 375	
1.2 16V	1.1	48	06.08-	D4F 740	4	ZS 325	
1.2 16V	1.1	55	06.05-05.08	D4F 740	4	ZS 375	
1.2 16V	1.1	55	06.08-	D4F 740	4	ZS 325	
1.2 16V	1.1	58	06.05-05.08	D4F 764	4	ZS 375	
1.2 16V	1.1	58	06.08-	D4F 764	4	ZS 325	
1.2 16V	1.1	74	05.07-05.08	D4F 784	4	ZS 375	
1.2 16V	1.1	74	06.08-	D4F 784	4	ZS 325	
1.2 16V	1.1	74	05.07-	D4F 784	4	ZS 354	
1.2 16V	1.1	76	09.10-	D4F 786	4	ZS 325	
1.2 16V	1.1	76	09.10-	D4F 786	4	ZS 375	
1.2 16V Hi-Flex	1.1	55	07.08-	D4F 740/D4F 742	4	ZS 325	
1.2 16V Hi-Flex	1.1	55	07.08-	D4F 740/D4F 742	4	ZS 375	
1.4 16V	1.4	72	06.05-	K4J 780	4	ZS 052 <sup>282</sup>	GS 29
1.6 16V	1.6	65	06.05-	K4M 804	4	ZS 052 <sup>282</sup>	GS 29
1.6 16V	1.6	82	06.05-	K4M 800/K4M 801	4	ZS 052 <sup>282</sup>	GS 29
1.6 16V GT	1.6	94	06.09-	K4M 862	4	ZS 052 <sup>282</sup>	GS 29
2.0 16V Sport	2.0	145	02.06-	F4R 830	4	ZS 052 <sup>282</sup>	GS 29
2.0 16V Sport	2.0	148	09.08-	F4R 830	4	ZS 052 <sup>282</sup>	GS 29



kw

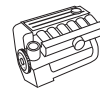

**RENAULT**

<b>RENAULT</b>							
<b>ESPACE I</b>							
2.0	2.0	74	01.88–12.90	J6R 734	4		<b>ZS 251</b> <sup>202</sup>
2.0	2.0	74	01.88–12.90	J6R 734	4		<b>ZS 316</b> <sup>202</sup>
2.0	2.0	80	07.84–12.90	J6R 234/J6R 236	4		<b>ZS 251</b> <sup>202</sup>
2.0	2.0	80	07.84–12.90	J6R 234/J6R 236	4		<b>ZS 316</b> <sup>202</sup>
2.0 i	2.0	87	01.89–12.90	J7R 760	4		<b>ZS 251</b> <sup>202</sup>
2.0 i	2.0	87	01.89–12.90	J7R 760	4		<b>ZS 316</b> <sup>202</sup>
2.0 i Quadra	2.0	87	03.88–12.92	J7R 760	4		<b>ZS 251</b> <sup>202</sup>
2.0 i Quadra	2.0	87	03.88–12.92	J7R 760	4		<b>ZS 316</b> <sup>202</sup>
2.2	2.2	79	07.86–12.90	J7T 770	4		<b>ZS 251</b> <sup>202</sup>
2.2	2.2	79	07.86–12.90	J7T 770	4		<b>ZS 316</b> <sup>202</sup>
2.2 Quadra	2.2	79	01.88–12.90	J7T 770	4		<b>ZS 251</b> <sup>202</sup>
2.2 Quadra	2.2	79	01.88–12.90	J7T 770	4		<b>ZS 316</b> <sup>202</sup>
<b>ESPACE II</b>							
2.0	2.0	76	01.91–10.96	J7R 768	4		<b>ZS 251</b> <sup>202</sup>
2.0	2.0	76	01.91–10.96	J7R 768	4		<b>ZS 316</b> <sup>202</sup>
2.2	2.2	79	01.91–10.96	J7T 772/J7T 776/J7T 773	4		<b>ZS 251</b> <sup>202</sup>
2.2	2.2	79	01.91–10.96	J7T 772/J7T 776/J7T 773	4		<b>ZS 316</b> <sup>202</sup>
2.2 4x4	2.2	79	03.91–12.96	J7T 772/J7T 773	4		<b>ZS 251</b> <sup>202</sup>
2.2 4x4	2.2	79	03.91–12.96	J7T 772/J7T 773	4		<b>ZS 316</b> <sup>202</sup>
2.8 V6	2.8	110	01.91–10.96	Z7W 717/Z7W 712/Z7W 713	6		<b>ZS 251</b> <sup>202</sup>
2.8 V6	2.8	110	01.91–10.96	Z7W 717/Z7W 712/Z7W 713	6		<b>ZS 316</b> <sup>202</sup>
<b>ESPACE III</b>							
2.0	2.0	84	11.96–10.00	F3R 769/F3R 728/F3R 742/F3R 729/ F3R 768	4		<b>ZS 052</b> <sup>282</sup> <b>GS 29</b>
2.0	2.0	84	04.97–10.00	F3R 769/F3R 728/F3R 742/F3R 729/ F3R 768	4		<b>ZS 315</b>
2.0	2.0	84	11.96–10.00	F3R 769/F3R 728/F3R 742/F3R 729/ F3R 768	4		<b>ZS 317</b> <sup>120</sup>
2.0	2.0	102	09.01–10.02	F4R 701/F4R 700	4		<b>ZS 052</b> <sup>282</sup> <b>GS 29</b>
2.0 16V	2.0	103	10.98–10.02	F4R 701/F4R 700	4		<b>ZS 052</b> <sup>282</sup> <b>GS 29</b>
3.0	3.0	123	11.96–10.98	Z7X 775	6		<b>ZS 317</b> <sup>120</sup>
3.0	3.0	123	11.96–10.98	Z7X 775	6		<b>ZS 318</b> <sup>118</sup>
3.0	3.0	123	11.96–10.98	Z7X 775	6		<b>ZS 319</b> <sup>119</sup>
3.0 V6 24V	2.9	140	10.98–10.02	L7X 727	6		<b>ZS 343</b>
<b>ESPACE IV</b>							
2.0	2.0	100	11.02–	F4R 792	4		<b>ZS 052</b> <sup>282</sup> <b>GS 29</b>
2.0	2.0	125	04.05–	F4R 897/F4R 796/F4R 896/F4R 797	4		<b>ZS 052</b> <sup>282</sup> <b>GS 29</b>
2.0 Turbo	2.0	120	11.02–	F4R 796/F4R 795/F4R 794/F4R 797	4		<b>ZS 052</b> <sup>282</sup> <b>GS 29</b>
<b>FLUENCE</b>							
1.6 16V	1.6	81	02.10–	K4M 839/K4M 838	4		<b>ZS 052</b> <sup>282</sup> <b>GS 29</b>
<b>FUEGO</b>							
1.6 Turbo	1.6	97	08.83–10.85	A5L 750	4	<b>ZM 005</b>	
<b>GRAND SCÉNIC II</b>							
1.6	1.6	77	06.06–	K4M 788	4		<b>ZS 052</b> <sup>282</sup> <b>GS 29</b>
1.6	1.6	83	04.04–	K4M 761/K4M 782	4		<b>ZS 052</b> <sup>282</sup> <b>GS 29</b>
2.0	2.0	99	04.04–	F4R 771/F4R 770	4		<b>ZS 052</b> <sup>282</sup> <b>GS 29</b>
2.0	2.0	120	04.04–	F4R 776	4		<b>ZS 052</b> <sup>282</sup> <b>GS 29</b>
<b>GRAND SCÉNIC III</b>							
1.2 TCe	1.2	85	04.12–	H5F 400	4		<b>ZSE 131</b>
1.4 16V	1.4	96	02.09–	H4J 700	4		<b>ZSE 066</b>
1.6 16V	1.6	81	06.09–	K4M.8.66	4		<b>ZS 052</b> <sup>282</sup> <b>GS 29</b>
<b>KANGOO</b>							
1.2	1.1	43	08.97–	D7F 710/D7F 744/D7F 722/D7F 720/ D7F 726/D7F 746	4		<b>ZS 354</b>
1.2	1.1	43	03.03–	D7F 710/D7F 744/D7F 722/D7F 720/ D7F 726/D7F 746	4		<b>ZS 345</b>
1.2	1.1	44	07.98–07.01	D7F 766/D7F 764 Mot.Nr.981022→	4		<b>ZS 345</b>
1.2 16V	1.1	55	03.03–	D4F 714/D4F 716/D4F 712	4		<b>ZS 345</b>
1.2 16V	1.1	55	07.04–	D4F 714/D4F 716/D4F 712	4		<b>ZS 325</b>
1.2 16V	1.1	55	07.04–	D4F 714/D4F 716/D4F 712	4		<b>ZS 375</b>
1.4	1.4	55	08.97–	E7J 780	4		<b>ZS 242</b> <sup>120</sup>



kW



## RENAULT

## KANGOO

1.4	1.4	55	08.97-	E7J 780	4		ZS 243 <sup>121</sup>	
1.4	1.4	55	08.97-	E7J 634/K7J 701/E7J 635/E7J 780/ K7J 700	4		ZS 354	
1.6 16V	1.6	70	06.01-	K4M 750/K4M 753/K4M 752	4		ZS 052 <sup>282</sup>	GS 29
1.6 16V 4x4	1.6	70	10.01-	K4M 750/K4M 753/K4M 752	4		ZS 052 <sup>282</sup>	GS 29
<b>KANGOO Express</b>								
1.6	1.6	64	02.08-	K7M 750	4		ZS 052 <sup>282</sup>	GS 29
1.6	1.6	64	02.08-	K7M 750	4		ZS 354	
1.6 16V	1.6	78	02.08-	K4M 830	4		ZS 052 <sup>282</sup>	GS 29
<b>KANGOO Rapid</b>								
1.2	1.1	43	08.97-	D7F 710/D7F 744/D7F 722/D7F 720/ D7F 726/D7F 746	4		ZS 354	
1.2	1.1	43	03.03-	D7F 710/D7F 744/D7F 722/D7F 720/ D7F 726/D7F 746	4		ZS 345	
1.2 16V	1.1	55	03.03-	D4F 714/D4F 712/D4F 730	4		ZS 345	
1.2 16V	1.1	55	06.08-	D4F 714/D4F 712/D4F 730	4		ZS 325	
1.2 16V	1.1	55	06.08-	D4F 714/D4F 712/D4F 730	4		ZS 375	
1.4	1.4	55	08.97-	E7J 634/K7J 701/E7J 635/E7J 780	4		ZS 242 <sup>120</sup>	
1.4	1.4	55	08.97-	E7J 634/K7J 701/E7J 635/E7J 780	4		ZS 243 <sup>121</sup>	
1.4	1.4	55	08.97-	E7J 634/K7J 701/E7J 635/E7J 780	4		ZS 354	
1.6 16V	1.6	70	10.01-	K4M 752	4		ZS 052 <sup>282</sup>	GS 29
1.6 16V 4x4	1.6	70	10.01-	K4M 750/K4M 753/K4M 752	4		ZS 052 <sup>282</sup>	GS 29

## KOLEOS

2.5	2.5	126	09.08-	2TR 702/2TR 700/2TR 703	4		ZSE 088	
2.5 4x4	2.5	126	09.08-	2TR 702/2TR 700/2TR 703	4		ZSE 088	

## LAGUNA Coupe

2.0 16V Turbo	2.0	125	09.08-	F4Rt 811/F4R 811	4		ZS 052 <sup>282</sup>	GS 29
2.0 GT	2.0	150	09.08-	F4Rt 800	4		ZS 052 <sup>282</sup>	GS 29

## LAGUNA Grandtour

1.6 16V	1.6	79	11.97-03.01	K4M 720	4		ZS 052 <sup>282</sup>	GS 29
1.8	1.8	66	09.95-03.01	F3P 670	4		ZS 251	
1.8	1.8	66	09.95-03.01	F3P 678/F3P 670	4		ZS 315	
1.8	1.8	66	09.95-03.01	F3P 670	4		ZS 316	
1.8	1.8	66	09.95-03.01	F3P 670	4		ZS 317 <sup>120</sup>	
1.8 16V	1.8	88	04.98-03.01	F4P 760	4		ZS 052 <sup>282</sup>	GS 29
2.0	2.0	83	01.96-03.01	F3R 722/F3R 723	4		ZS 251	
2.0	2.0	83	01.96-03.01	F3R 722/F3R 723	4		ZS 316	
2.0	2.0	83	09.95-03.01	F3R 722/F3R 723	4		ZS 317 <sup>120</sup>	
2.0	2.0	84	10.98-01.01	F3R 768	4		ZS 315	
2.0	2.0	84	10.98-01.01	F3R 768	4		ZS 317 <sup>120</sup>	
2.0 16V	1.9	102	09.95-03.01	N7Q 700/N7Q 704	4		ZS 254 <sup>120</sup>	
2.0 16V	1.9	102	09.95-03.01	N7Q 700/N7Q 704	4		ZS 255 <sup>121</sup>	
2.0 16V	2.0	103	09.99-03.01	F4R 780	4		ZS 052 <sup>282</sup>	GS 29
3.0	3.0	123	02.96-03.01	Z7X 765	6		ZS 317 <sup>120</sup>	
3.0	3.0	123	02.96-03.01	Z7X 765	6		ZS 318 <sup>118</sup>	
3.0	3.0	123	02.96-03.01	Z7X 765	6		ZS 319 <sup>119</sup>	

## LAGUNA I

1.6 16V	1.6	79	11.97-03.01	K4M 720	4		ZS 052 <sup>282</sup>	GS 29
1.8	1.8	66	08.95-03.01	F3P 678	4		ZS 251	
1.8	1.8	66	08.95-03.01	F3P 670	4		ZS 315	
1.8	1.8	66	08.95-03.01	F3P 678	4		ZS 316	
1.8	1.8	66	08.95-03.01	F3P 670	4		ZS 317 <sup>120</sup>	
1.8	1.8	66	11.93-03.01	F3P 720/F3P 724	4		ZS 251	
1.8	1.8	69	06.95-03.97	F3P 674	4		ZS 317 <sup>120</sup>	
1.8	1.8	69	04.97-02.01	F3P 674	4		ZS 315	
1.8	1.8	69	08.95-03.01	F3P 720/F3P 724 Mot.Nr.→970402	4		ZS 317 <sup>120</sup>	
1.8	1.8	69	08.95-03.01	F3P 720/F3P 724 Mot.Nr.970403→	4		ZS 315	
1.8 16V	1.8	88	04.98-03.01	F4P 760	4		ZS 052 <sup>282</sup>	GS 29
2.0	2.0	83	11.93-03.01	F3R 722/F3R 723	4		ZS 251	
2.0	2.0	83	11.93-03.01	F3R 722/F3R 723	4		ZS 316	





kW

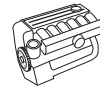

**RENAULT**

**LAGUNA I**

2.0	2.0	84	06.95-02.01	F3R 768	4		<b>ZS 315</b>	
2.0	2.0	84	06.95-02.01	F3R 768	4		<b>ZS 317</b> <sup>120</sup>	
2.0 16V	1.9	102	06.95-03.01	N7Q 700/N7Q 704	4		<b>ZS 254</b> <sup>120</sup>	
2.0 16V	1.9	102	06.95-03.01	N7Q 700/N7Q 704	4		<b>ZS 255</b> <sup>121</sup>	
2.0 16V	2.0	103	09.99-03.01	F4R 780	4		<b>ZS 052</b> <sup>282</sup>	<b>GS 29</b>
3.0	3.0	123	11.93-03.01	Z7X 765/Z7X 760	6		<b>ZS 317</b> <sup>120</sup>	
3.0	3.0	123	11.93-03.01	Z7X 765/Z7X 760	6		<b>ZS 318</b> <sup>118</sup>	
3.0	3.0	123	11.93-03.01	Z7X 765/Z7X 760	6		<b>ZS 319</b> <sup>119</sup>	

**LAGUNA II**

1.6 16V	1.6	79	03.01-	K4M 714/K4M 710	4		<b>ZS 052</b> <sup>282</sup>	<b>GS 29</b>
1.6 16V	1.6	82	02.05-	K4M 716	4		<b>ZS 052</b> <sup>282</sup>	<b>GS 29</b>
1.8 16V	1.8	85	03.01-	F4P 774/F4P 770/F4P 773/F4P 771/ F4P 775	4		<b>ZS 052</b> <sup>282</sup>	<b>GS 29</b>
1.8 16V	1.8	86	03.01-	F4P 774/F4P 770	4		<b>ZS 052</b> <sup>282</sup>	<b>GS 29</b>
1.8 16V	1.8	88	03.01-	F4P 770/F4P 773	4		<b>ZS 052</b> <sup>282</sup>	<b>GS 29</b>
1.8 16V	1.8	89	03.01-	F4P 772/F4P 770	4		<b>ZS 052</b> <sup>282</sup>	<b>GS 29</b>
2.0 16V	2.0	99	08.02-	F4R 713/F4R 715/F4R 712/F4R 714	4		<b>ZS 052</b> <sup>282</sup>	<b>GS 29</b>
2.0 16V	2.0	125	01.05-	F4R 787/F4R 786/F4R 784	4		<b>ZS 052</b> <sup>282</sup>	<b>GS 29</b>
2.0 16V	2.0	150	01.05-09.07	F4R 887/F4R 886	4		<b>ZS 052</b> <sup>282</sup>	<b>GS 29</b>
2.0 16V IDE	2.0	103	04.01-02.05	F5R 701	4		<b>ZS 052</b> <sup>282</sup>	<b>GS 29</b>
2.0 16V IDE	2.0	103	04.01-	F5R 701/F5R 700	4		<b>ZS 345</b>	
2.0 16V Turbo	2.0	120	01.03-	F4R 764/F4R 787/F4R 786/F4R 765	4		<b>ZS 052</b> <sup>282</sup>	<b>GS 29</b>
3.0 V6 24V	2.9	152	03.01-	L7X 731	6		<b>ZS 347</b>	

**LAGUNA II Grandtour**

1.6 16V	1.6	79	03.01-	K4M 714/K4M 710	4		<b>ZS 052</b> <sup>282</sup>	<b>GS 29</b>
1.6 16V	1.6	82	02.05-	K4M 716	4		<b>ZS 052</b> <sup>282</sup>	<b>GS 29</b>
1.8 16V	1.8	85	03.01-	F4P 774/F4P 770/F4P 771/F4P 775	4		<b>ZS 052</b> <sup>282</sup>	<b>GS 29</b>
1.8 16V	1.8	86	03.01-	F4P 770	4		<b>ZS 052</b> <sup>282</sup>	<b>GS 29</b>
1.8 16V	1.8	88	03.01-	F4P 770/F4P 773	4		<b>ZS 052</b> <sup>282</sup>	<b>GS 29</b>
1.8 16V	1.8	89	03.01-	F4P 774/F4P 770	4		<b>ZS 052</b> <sup>282</sup>	<b>GS 29</b>
2.0 16V	2.0	99	08.02-	F4R 713/F4R 715/F4R 712/F4R 714	4		<b>ZS 052</b> <sup>282</sup>	<b>GS 29</b>
2.0 16V	2.0	125	01.05-	F4R 787/F4R 786/F4R 784	4		<b>ZS 052</b> <sup>282</sup>	<b>GS 29</b>
2.0 16V	2.0	150	01.05-	F4R.784 , F4R.786	4		<b>ZS 052</b> <sup>282</sup>	<b>GS 29</b>
2.0 16V IDE	2.0	103	04.01-	F5R 701	4		<b>ZS 052</b> <sup>282</sup>	<b>GS 29</b>
2.0 16V IDE	2.0	103	04.01-	F5R 701/F5R 700	4		<b>ZS 345</b>	
2.0 16V Turbo	2.0	120	01.03-	F4R 764/F4R 787/F4R 786/F4R 765	4		<b>ZS 052</b> <sup>282</sup>	<b>GS 29</b>
3.0 V6 24V	2.9	152	03.01-	L7X 731	6		<b>ZS 347</b>	

**LAGUNA III**

1.6 16V	1.6	81	10.07-	K4M 824	4		<b>ZS 052</b> <sup>282</sup>	<b>GS 29</b>
2.0 16V Turbo	2.0	125	10.07-	F4R 811	4		<b>ZS 052</b> <sup>282</sup>	<b>GS 29</b>
2.0 GT	2.0	150	03.08-	F4R 800	4		<b>ZS 052</b> <sup>282</sup>	<b>GS 29</b>

**LAGUNA III Grandtour**

1.6 16V	1.6	81	10.07-	K4M 824	4		<b>ZS 052</b> <sup>282</sup>	<b>GS 29</b>
2.0 16V Turbo	2.0	125	10.07-	F4R 811	4		<b>ZS 052</b> <sup>282</sup>	<b>GS 29</b>
2.0 GT	2.0	150	03.08-	F4R 800	4		<b>ZS 052</b> <sup>282</sup>	<b>GS 29</b>

**LOGAN**

1.4	1.4	55	09.04-	K7J 710	4		<b>ZS 354</b>	
1.6	1.6	64	09.04-	K7M 710	4		<b>ZS 354</b>	
1.6	1.6	77	04.07-	K4M 690	4		<b>ZS 052</b> <sup>282</sup>	<b>GS 29</b>

**LOGAN Kombi**

1.4	1.4	55	10.07-	K7J 710	4		<b>ZS 354</b>	
1.6	1.6	64	04.07-	K7M 710	4		<b>ZS 354</b>	
1.6	1.6	77	04.07-	K4M 697	4		<b>ZS 052</b> <sup>282</sup>	<b>GS 29</b>

**MEGANE CC**

1.4 TCe	1.4	96	06.10-	H4J 700	4		<b>ZSE 066</b>	
1.6 16V	1.6	81	06.10-	K4M.8.58	4		<b>ZS 052</b> <sup>282</sup>	<b>GS 29</b>
2.0 TCe	2.0	132	06.10-	F4R 872	4		<b>ZS 052</b> <sup>282</sup>	<b>GS 29</b>

**MEGANE I**

1.4 16V	1.4	70	03.99-08.03	K4J 714/K4J 750	4		<b>ZS 052</b> <sup>282</sup>	<b>GS 29</b>
1.4 e	1.4	55	01.96-02.99	E7J 626/E7J 764	4		<b>ZS 251</b>	
1.4 e	1.4	55	01.96-08.03	E7J 626	4		<b>ZS 052</b> <sup>282</sup>	<b>GS 29</b>



kW



## RENAULT

## MEGANE I

1.4 e	1.4	55	02.99-08.03	E7J 626/E7J 764	4	ZS 354	
1.4 Eco	1.4	52	01.96-03.99	E7J 624	4	ZS 251	
1.4 Eco	1.4	52	01.96-03.99	E7J 624	4	ZS 316	
1.6 16V	1.6	79	03.99-08.03	K4M 704/K4M 700/K4M 708/K4M 701	4	ZS 052 <sup>282</sup>	GS 29
1.6 e	1.6	66	01.96-03.97	K7M 702/K7M 703/K7M 790	4	ZS 245 <sup>120</sup>	
1.6 e	1.6	66	01.96-03.97	K7M 702/K7M 703/K7M 790	4	ZS 246 <sup>121</sup>	
1.6 e	1.6	66	04.97-03.99	K7M 702/K7M 703/K7M 790	4	ZS 242 <sup>120</sup>	
1.6 e	1.6	66	04.97-03.99	K7M 702/K7M 703/K7M 790	4	ZS 243 <sup>121</sup>	
1.6 e	1.6	66	01.96-03.99	K7M 702/K7M 703/K7M 790	4	ZS 354	
1.6 i	1.6	55	01.96-03.97	K7M 720	4	ZS 245 <sup>120</sup>	
1.6 i	1.6	55	01.96-03.97	K7M 720	4	ZS 246 <sup>121</sup>	
1.6 i	1.6	55	04.97-03.99	K7M 720	4	ZS 242 <sup>120</sup>	
1.6 i	1.6	55	04.97-03.99	K7M 720	4	ZS 243 <sup>121</sup>	
1.8 16V	1.8	85	01.01-08.03	F4P 722/F4P 720	4	ZS 052 <sup>282</sup>	GS 29
2.0 16V	2.0	108	07.96-08.03	F7R 710/F7R 714	4	ZS 052 <sup>282</sup>	GS 29
2.0 i	2.0	84	01.96-08.03	F3R 751/F3R 750	4	ZS 315	
2.0 i	2.0	84	01.96-08.03	F3R 751/F3R 750	4	ZS 317 <sup>120</sup>	
<b>MEGANE I Cabriolet</b>							
1.4 16V	1.4	70	03.99-08.03	K4J 714/K4J 750	4	ZS 052 <sup>282</sup>	GS 29
1.6 16V	1.6	79	03.99-08.03	K4M 700/K4M 708/K4M 701	4	ZS 052 <sup>282</sup>	GS 29
1.6 e	1.6	66	10.96-03.97	K7M 702/K7M 703	4	ZS 245 <sup>120</sup>	
1.6 e	1.6	66	10.96-03.97	K7M 702/K7M 703	4	ZS 246 <sup>121</sup>	
1.6 e	1.6	66	04.97-03.99	K7M 702/K7M 703	4	ZS 242 <sup>120</sup>	
1.6 e	1.6	66	04.97-03.99	K7M 702/K7M 703	4	ZS 243 <sup>121</sup>	
1.6 e	1.6	66	10.96-03.99	K7M 702/K7M 703	4	ZS 354	
2.0 16V	2.0	102	01.02-08.03	F4R 746/F4R 770	4	ZS 052 <sup>282</sup>	GS 29
2.0 16V IDE	2.0	103	11.99-08.03	F5R 740	4	ZS 345	
2.0 i	2.0	80	03.99-08.03	F3R 791/F3R 796	4	ZS 315	
2.0 i	2.0	80	03.99-08.03	F3R 791/F3R 796	4	ZS 317 <sup>120</sup>	
<b>MEGANE I Classic</b>							
1.4	1.4	55	09.96-08.03	E7J 626	4	ZS 052 <sup>282</sup>	GS 29
1.4	1.4	55	09.96-08.03	E7J 626/E7J 764	4	ZS 251	
1.4	1.4	55	09.96-08.03	E7J 626/E7J 764	4	ZS 316	
1.4	1.4	55	09.96-08.03	E7J 626/E7J 764	4	ZS 354	
1.4 16V	1.4	70	03.99-08.03	K4J 714/K4J 750	4	ZS 052 <sup>282</sup>	GS 29
1.6 16V	1.6	79	03.99-08.03	K4M 700/K4M 708/K4M 701	4	ZS 052 <sup>282</sup>	GS 29
1.6 e	1.6	66	09.96-03.97	K7M 702/K7M 703/K7M 790	4	ZS 245 <sup>120</sup>	
1.6 e	1.6	66	09.96-03.97	K7M 702/K7M 703/K7M 790	4	ZS 246 <sup>121</sup>	
1.6 e	1.6	66	04.97-03.99	K7M 702/K7M 703/K7M 790	4	ZS 242 <sup>120</sup>	
1.6 e	1.6	66	04.97-03.99	K7M 702/K7M 703/K7M 790	4	ZS 243 <sup>121</sup>	
1.6 i	1.6	55	09.96-03.97	K7M 720	4	ZS 245 <sup>120</sup>	
1.6 i	1.6	55	09.96-03.97	K7M 720	4	ZS 246 <sup>121</sup>	
1.6 i	1.6	55	04.97-03.99	K7M 720	4	ZS 242 <sup>120</sup>	
1.6 i	1.6	55	04.97-03.99	K7M 720	4	ZS 243 <sup>121</sup>	
1.8 16V	1.8	85	01.01-08.03	F4P 722/F4P 720	4	ZS 052 <sup>282</sup>	GS 29
2.0 i	2.0	84	09.96-08.03	F3R 791/F3R 751/F3R 797/F3R 798/ F3R 796/F3R 752/F3R 750	4	ZS 315	
2.0 i	2.0	84	09.96-08.03	F3R 791/F3R 751/F3R 797/F3R 798/ F3R 796/F3R 752/F3R 750	4	ZS 317 <sup>120</sup>	
<b>MEGANE I Coach</b>							
1.4 16V	1.4	70	03.99-08.03	K4J 714/K4J 750	4	ZS 052 <sup>282</sup>	GS 29
1.6 16V	1.6	79	03.99-08.03	K4M 700/K4M 708/K4M 701	4	ZS 052 <sup>282</sup>	GS 29
1.6 e	1.6	66	03.96-03.97	K7M 702/K7M 703	4	ZS 245 <sup>120</sup>	
1.6 e	1.6	66	03.96-03.97	K7M 702/K7M 703	4	ZS 246 <sup>121</sup>	
1.6 e	1.6	66	04.97-03.99	K7M 702/K7M 703	4	ZS 242 <sup>120</sup>	
1.6 e	1.6	66	04.97-03.99	K7M 702/K7M 703	4	ZS 243 <sup>121</sup>	
2.0 16V	2.0	108	02.99-11.99	F7R 710/F7R 714	4	ZS 345	
2.0 16V IDE	2.0	103	06.00-08.03	F5R 740	4	ZS 345	
2.0 i	2.0	80	03.99-08.03	F3R 791/F3R 796	4	ZS 345	
2.0 i	2.0	84	03.96-08.03	F3R 751/F3R 750	4	ZS 315	
2.0 i	2.0	84	03.96-08.03	F3R 751/F3R 750	4	ZS 317 <sup>120</sup>	



kW

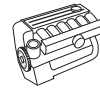

**RENAULT**

**MEGANE I Grandtour**

1.4 16V	1.4	70	03.99-08.03	K4J 714/K4J 750	4	ZS 052 <sup>282</sup>	GS 29
1.4 e	1.4	55	03.99-08.03	E7J 626	4	ZS 052 <sup>282</sup>	GS 29
1.4 e	1.4	55	03.99-08.03	E7J 626	4	ZS 354	
1.6 16V	1.6	79	03.99-08.03	K4M 704/K4M 700/K4M 708/K4M 701	4	ZS 052 <sup>282</sup>	GS 29
1.6 e	1.6	66	03.99-08.03	K7M 702/K7M 703	4	ZS 354	
1.8 16V	1.8	85	01.01-08.03	F4P 722/F4P 720	4	ZS 052 <sup>282</sup>	GS 29

**MEGANE II**

1.4 16V	1.4	60	10.03-	K4J 732	4	ZS 052 <sup>282</sup>	GS 29
1.4 16V	1.4	72	11.02-	K4J 740/K4J 730	4	ZS 052 <sup>282</sup>	GS 29
1.6	1.6	77	06.05-	K4M 788	4	ZS 052 <sup>282</sup>	GS 29
1.6 16V	1.6	82	01.06-	K4M 812/K4M 760/K4M 813	4	ZS 052 <sup>282</sup>	GS 29
1.6 16V	1.6	83	11.02-	K4M 760	4	ZS 052 <sup>282</sup>	GS 29
1.6 Flex-Fuel	1.6	77	01.07-	K4M 788	4	ZS 052 <sup>282</sup>	GS 29
2.0	2.0	169	08.06-	F4R 774	4	ZS 052 <sup>282</sup>	GS 29
2.0 16V	2.0	99	11.02-	F4R 770	4	ZS 052 <sup>282</sup>	GS 29
2.0 16V Turbo	2.0	120	05.04-	F4R 776	4	ZS 052 <sup>282</sup>	GS 29
2.0 Renault Sport	2.0	165	05.04-	F4R 774/F4Rt 774	4	ZS 052 <sup>282</sup>	GS 29

**MEGANE II Coupé-Cabriolet**

1.6	1.6	77	06.05-	K4M 788	4	ZS 052 <sup>282</sup>	GS 29
1.6	1.6	83	09.03-	K4M 760/K4M 761	4	ZS 052 <sup>282</sup>	GS 29
1.6 16V	1.6	82	01.06-	K4M C 813/K4M 812/K4M 760/K4M 761/ K4M 813/K4M D 812	4	ZS 052 <sup>282</sup>	GS 29
2.0	2.0	99	09.03-	F4R 771/F4R 770	4	ZS 052 <sup>282</sup>	GS 29
2.0 16V Turbo	2.0	120	05.04-	F4R 776	4	ZS 052 <sup>282</sup>	GS 29

**MEGANE II Grandtour**

1.4	1.4	72	08.03-	K4J 740/K4J 730	4	ZS 052 <sup>282</sup>	GS 29
1.6	1.6	83	08.03-	K4M 760/K4M 761	4	ZS 052 <sup>282</sup>	GS 29
1.6 16V	1.6	82	01.06-	K4M 812/K4M 760/K4M 761/K4M 813/ K4M D 812	4	ZS 052 <sup>282</sup>	GS 29
1.6 16V Hi-Flex	1.6	77	02.08-	K4M 762	4	ZS 052 <sup>282</sup>	GS 29
2.0	2.0	99	08.03-	F4R 771/F4R 770	4	ZS 052 <sup>282</sup>	GS 29

**MEGANE III**

1.2 TCe	1.2	85	03.12-	H5F 400	4	ZSE 131	
1.4 TCe	1.4	96	04.09-	H4J 700	4	ZSE 066	
1.6 16V	1.6	74	11.08-	K4M 848	4	ZS 052 <sup>282</sup>	GS 29
1.6 16V	1.6	81	11.08-	K4M 858	4	ZS 052 <sup>282</sup>	GS 29
1.6 16V Bifuel	1.6	81	11.08-	K4M 866	4	ZS 052 <sup>282</sup>	GS 29
2.0 TCe	2.0	132	11.08-	F4R 870	4	ZS 052 <sup>282</sup>	GS 29

**MEGANE III Coupe**

1.2 TCe	1.2	85	03.12-	H5F 400	4	ZSE 131	
1.4 TCe	1.4	96	04.09-	H4J 700	4	ZSE 066	
1.6 16V	1.6	74	11.08-	K4M P 848	4	ZS 052 <sup>282</sup>	GS 29
1.6 16V	1.6	81	11.08-	K4M 858	4	ZS 052 <sup>282</sup>	GS 29
1.6 16V Bifuel	1.6	81	11.08-	K4M 866	4	ZS 052 <sup>282</sup>	GS 29
2.0 TCe	2.0	132	11.08-	F4R 870	4	ZS 052 <sup>282</sup>	GS 29
2.0 TCe	2.0	184	05.09-	F4R 874	4	ZS 052 <sup>282</sup>	GS 29

**MEGANE III Grandtour**

1.2 TCe	1.2	85	03.12-	H5F 400	4	ZSE 131	
1.4 TCe	1.4	96	05.09-	H4J 700	4	ZSE 066	
1.6 16V	1.6	74	05.09-	K4M 848	4	ZS 052 <sup>282</sup>	GS 29
1.6 16V	1.6	81	05.09-	K4M 858	4	ZS 052 <sup>282</sup>	GS 29
1.6 16V Bifuel	1.6	81	11.08-	K4M 866	4	ZS 052 <sup>282</sup>	GS 29
2.0 TCe	2.0	132	11.08-	F4R 870/F4R 872	4	ZS 052 <sup>282</sup>	GS 29

**MEGANE Scenic**

1.6 16V	1.6	79	04.98-10.99	K4M 704/K4M 700/K4M 708/K4M 701	4	ZS 052 <sup>282</sup>	GS 29
1.6 e	1.6	66	01.97-03.97	K7M 702/K7M 703	4	ZS 245 <sup>120</sup>	
1.6 e	1.6	66	01.97-03.97	K7M 702/K7M 703	4	ZS 246 <sup>121</sup>	
1.6 e	1.6	66	04.97-09.99	K7M 702/K7M 703	4	ZS 242 <sup>120</sup>	
1.6 e	1.6	66	04.97-09.99	K7M 702/K7M 703	4	ZS 243 <sup>121</sup>	
1.6 e	1.6	66	09.97-09.99	K7M 702/K7M 703	4	ZS 354	
1.6 i	1.6	55	01.97-03.97	K7M 720	4	ZS 245 <sup>120</sup>	



kW

**RENAULT****MEGANE Scenic**

1.6 i	1.6	55	01.97–03.97	K7M 720	4	<b>ZS 246</b> <sup>121</sup>	
1.6 i	1.6	55	04.97–09.99	K7M 720	4	<b>ZS 242</b> <sup>120</sup>	
1.6 i	1.6	55	04.97–09.99	K7M 720	4	<b>ZS 243</b> <sup>121</sup>	
1.6 i	1.6	55	09.97–09.99	K7M 720	4	<b>ZS 354</b>	
2.0 i	2.0	80	01.99–09.99	F3R 796	4	<b>ZS 315</b>	
2.0 i	2.0	80	01.99–09.99	F3R 796	4	<b>ZS 317</b> <sup>120</sup>	
2.0 i	2.0	84	01.97–09.99	F3R 751/F3R 750	4	<b>ZS 315</b>	
2.0 i	2.0	84	01.97–09.99	F3R 751/F3R 750	4	<b>ZS 317</b> <sup>120</sup>	

**MODUS**

1.2	1.1	48	05.05–	D4F 740	4	<b>ZS 325</b>	
1.2	1.1	48	05.05–	D4F 740	4	<b>ZS 375</b>	
1.2	1.1	55	12.04–	D4F 740	4	<b>ZS 325</b>	
1.2	1.1	55	12.04–	D4F 740	4	<b>ZS 375</b>	
1.2 16V	1.1	74	05.07–	D4F 784	4	<b>ZS 354</b>	
1.2 16V Hi-Flex	1.1	55	10.08–	D4F 740	4	<b>ZS 325</b>	
1.2 16V Hi-Flex	1.1	55	10.08–	D4F 740	4	<b>ZS 375</b>	
1.4	1.4	72	12.04–	K4J 770	4	<b>ZS 052</b> <sup>282</sup>	<b>GS 29</b>
1.6	1.6	65	12.04–	K4M 794	4	<b>ZS 052</b> <sup>282</sup>	<b>GS 29</b>
1.6	1.6	82	12.04–	K4M 790/K4M 800/K4M 801/K4M 791	4	<b>ZS 052</b> <sup>282</sup>	<b>GS 29</b>
1.6	1.6	82	12.04–	K4M 790/K4M 800/K4M 801/K4M 791	4	<b>ZS 354</b>	

**R 4**

0.8	0.8	25	09.71–12.88	800 01	4	<b>ZS 106</b>	
1.1	1.1	25	06.78–06.90	C1E 714/C1E 719/688 712	4	<b>ZS 106</b>	
1.1	1.1	32	06.86–06.90	C1E 714	4	<b>ZS 110</b>	

**R 5**

0.8	0.8	26	10.72–08.84	800 710	4	<b>ZS 106</b>	
0.8	0.8	27	01.82–12.84	800 710	4	<b>ZS 106</b>	
1.3	1.3	33	06.79–09.84	810 719	4	<b>ZS 106</b>	
1.3	1.3	47	09.75–09.84	810 725	4	<b>ZS 110</b>	
1.3 Automatik	1.3	40	06.79–09.84	810 729	4	<b>ZS 106</b>	

**R 9**

1.1	1.1	35	09.81–05.87	C1E 715/C1E 720	4	<b>ZS 106</b>	
1.4 Turbo	1.4	77	04.84–12.86	C1J 764/C1J 760	4	<b>ZS 115</b>	
1.7	1.7	54	10.86–12.88	F3N 718	4	<b>ZS 251</b>	
1.7	1.7	54	10.86–12.88	F3N 718	4	<b>ZS 316</b>	
1.7	1.7	55	10.86–12.88	F2N 730	4	<b>ZS 251</b>	
1.7	1.7	55	10.86–12.88	F2N 730	4	<b>ZS 316</b>	
1.7	1.7	65	10.86–12.88	F2N 798/F2N 710/F2N 708	4	<b>ZS 251</b>	
1.7	1.7	65	10.86–12.88	F2N 798/F2N 710/F2N 708	4	<b>ZS 316</b>	
1.7	1.7	69	06.87–12.88	F3N 708	4	<b>ZS 251</b>	
1.7	1.7	69	06.87–12.88	F3N 708	4	<b>ZS 316</b>	

**R 11**

1.4 Turbo	1.4	77	04.84–12.86	C1J 764/C1J 760	4	<b>ZM 005</b>	
1.4 Turbo	1.4	85	10.86–12.88	C1J 770/C1J 782	4	<b>ZM 005</b>	
1.7	1.7	59	10.83–12.87	F2N 704/F2N 700	4	<b>ZS 251</b>	
1.7	1.7	59	10.83–12.87	F2N 704/F2N 700	4	<b>ZS 316</b>	

**R 18**

1.4	1.4	47	04.78–07.86	847 720/847 722	4	<b>ZS 106</b>	
1.6	1.6	54	04.82–07.86	841 717/A2M 723	4	<b>ZS 106</b>	
1.6 Turbo	1.6	92	01.83–07.86	A5L 718/A5L 717	4	<b>ZM 005</b>	
2.2 i	2.2	76	06.84–07.86	J7T 718	4	<b>ZS 251</b>	
2.2 i	2.2	76	06.84–07.86	J7T 718	4	<b>ZS 316</b>	

**R 19 i**

1.4	1.4	59	01.88–12.92	E6J 701/E6J 700	4	<b>ZS 251</b>	
1.4 KAT	1.4	43	01.89–04.92	C3J 710	4	<b>ZS 251</b>	
1.4 KAT	1.4	43	01.89–04.92	C3J 710	4	<b>ZS 316</b>	
1.7	1.7	66	09.88–04.92	F3N 743/F3N 742	4	<b>ZS 251</b> <sup>285</sup>	
1.7	1.7	66	09.88–04.92	F3N 743/F3N 742	4	<b>ZS 316</b> <sup>285</sup>	
1.8 16V	1.8	99	06.89–04.92	F7P 704	4	<b>ZS 251</b>	
1.8 16V	1.8	99	06.89–04.92	F7P 704	4	<b>ZS 316</b>	



kW



**RENAULT**

**R 19 II**

1.4	1.4	43	04.92-12.95	C3J 710	4		<b>ZS 251</b>	
1.4	1.4	43	04.92-12.95	C3J 710	4		<b>ZS 316</b>	
1.4	1.4	55	01.92-12.95	E7J 742	4		<b>ZS 251</b>	
1.4	1.4	59	01.92-12.95	E7J 706/E6J 700	4		<b>ZS 251</b>	
1.7	1.7	54	04.92-12.95	F3N 741/F3N 740	4		<b>ZS 251</b>	
1.7	1.7	66	04.92-12.95	F3N 743	4		<b>ZS 251</b>	
1.8	1.8	65	04.92-12.95	F3P 706/F3P 707/F3P 760/F3P 708	4		<b>ZS 251</b>	
1.8	1.8	65	04.92-12.95	F3P 706/F3P 707/F3P 760/F3P 708	4		<b>ZS 316</b>	
1.8	1.8	66	04.92-12.95	F3P 706/F3P 760	4		<b>ZS 251</b>	
1.8	1.8	66	04.92-12.95	F3P 706/F3P 760	4		<b>ZS 316</b>	
1.8	1.8	79	05.94-12.95	F3P 765/F3P 682	4		<b>ZS 250</b>	
1.8	1.8	81	04.92-05.94	F3P 700	4		<b>ZS 251</b>	
1.8	1.8	81	04.92-05.94	F3P 700	4		<b>ZS 316</b>	

**R 21**

1.7	1.7	54	09.89-10.92	F3N 726	4		<b>ZS 251</b>	
1.7	1.7	66	09.89-06.94	F3N 723/F3N 722	4		<b>ZS 251</b>	
2.0	2.0	99	02.90-10.92	J7R 740	4		<b>ZS 251</b>	
2.0	2.0	99	02.90-10.92	J7R 740	4		<b>ZS 316</b>	
2.0 4x4	2.0	99	09.90-10.92	J7R 740	4		<b>ZS 251</b>	
2.0 4x4	2.0	99	09.90-10.92	J7R 740	4		<b>ZS 316</b>	
2.2	2.2	79	09.89-06.94	J7T 754/J7T 755	4		<b>ZS 251</b>	
2.2	2.2	79	09.89-06.94	J7T 754/J7T 755	4		<b>ZS 316</b>	
2.2 4x4	2.2	79	07.90-06.94	J7T 754/J7T 755	4		<b>ZS 251</b>	
2.2 4x4	2.2	79	07.90-06.94	J7T 754/J7T 755	4		<b>ZS 316</b>	

**R 25**

2.0	2.0	74	04.84-12.92	J6R 763/J6R 707/J6R 760/J6R 706/ J6R 762	4		<b>ZS 251</b>	
2.0	2.0	74	04.84-12.92	J6R 763/J6R 707/J6R 760/J6R 706/ J6R 762	4		<b>ZS 316</b>	
2.0 12V	2.0	99	06.89-12.92	J7R 726	4		<b>ZS 251</b>	
2.0 12V	2.0	99	06.89-12.92	J7R 726	4		<b>ZS 316</b>	

**SAFRANE I**

2.2	2.2	101	04.92-07.96	J7T 760/J7T 761	4		<b>ZS 251</b>	
3.0 V6	3.0	123	12.92-07.96	Z7X 721/Z7X 723/Z7X 722	6	<b>ZM 052</b>		
3.0 V6 4x4	3.0	123	12.92-07.96	Z7X 722 , Z7X 723	6	<b>ZM 052</b>		

**SAFRANE II**

2.0 16V	1.9	100	07.96-12.00	N7Q 710/N7Q 711	4		<b>ZS 254</b> <sup>120</sup>	
2.0 16V	1.9	100	07.96-12.00	N7Q 710/N7Q 711	4		<b>ZS 255</b> <sup>121</sup>	
2.5 20V	2.4	121	07.96-12.00	N7U 700/N7U 701	5	<b>ZM 036</b>		
2.5 20V	2.4	121	07.96-12.00	N7U 700/N7U 701	5		<b>ZSE 037</b>	

**SANDERO/STEPWAY**

1.4	1.4	55	02.09-	K7J 710	4		<b>ZS 354</b>	
1.6	1.6	64	02.09-	K7M 710	4		<b>ZS 338</b>	

**SCÉNIC I**

1.4 16V	1.4	70	09.99-08.03	K4J 714/K4J 750	4		<b>ZS 052</b> <sup>282</sup>	<b>GS 29</b>
1.6	1.6	79	09.99-09.03	K4M 706	4		<b>ZS 052</b> <sup>282</sup>	
1.8 16V	1.8	85	01.01-08.03	F4P 722/F4P 720	4		<b>ZS 052</b> <sup>282</sup>	<b>GS 29</b>
1.8 4x4	1.8	85	07.00-04.01	F4P 722	4		<b>ZS 052</b> <sup>282</sup>	<b>GS 29</b>
2.0 16V	2.0	102	07.00-08.03	F4R 741/F4R 740/F4R 746	4		<b>ZS 052</b> <sup>282</sup>	<b>GS 29</b>
2.0 16V	2.0	103	09.99-08.03	F4R 741/F4R 740/F4R 744	4		<b>ZS 052</b> <sup>282</sup>	<b>GS 29</b>
2.0 16V RX4	2.0	102	06.00-08.03	F4R 746/F4R 744	4		<b>ZS 052</b> <sup>282</sup>	<b>GS 29</b>

**SCÉNIC II**

1.4	1.4	72	06.03-	K4J 740/K4J 730/K4J 770	4		<b>ZS 052</b> <sup>282</sup>	<b>GS 29</b>
1.6	1.6	77	06.06-	K4M 788	4		<b>ZS 052</b> <sup>282</sup>	<b>GS 29</b>
1.6	1.6	83	06.03-	K4M 761/K4M 782	4		<b>ZS 052</b> <sup>282</sup>	<b>GS 29</b>
1.6 16V	1.6	82	01.07-	K4M C 813/K4M 812/K4M 9 766	4		<b>ZS 052</b> <sup>282</sup>	<b>GS 29</b>
2.0	2.0	99	06.03-	F4R 771/F4R 770	4		<b>ZS 052</b> <sup>282</sup>	<b>GS 29</b>
2.0 16V Turbo	2.0	120	05.04-	F4R 776	4		<b>ZS 052</b> <sup>282</sup>	<b>GS 29</b>

**SCÉNIC III**

1.2 TCe	1.2	85	04.12-	H5F 400	4		<b>ZSE 131</b>	
1.4 16V	1.4	96	02.09-	H4J 700	4		<b>ZSE 066</b>	
1.6 16V	1.6	81	02.09-	K4M 858	4		<b>ZS 052</b> <sup>282</sup>	<b>GS 29</b>



kW

**RENAULT****SCÉNIC III**

1.6 E85	1.6	81	02.09–	K4M 866	4	ZS 052 <sup>282</sup>	GS 29
---------	-----	----	--------	---------	---	-----------------------	-------

**SUPER 5**

1.0	1.0	30	10.84–10.88	C1C 700	4	ZS 106	
1.1	1.1	33	01.86–03.95	C1E 752/C1E 750/C1E 756/C1E 760	4	ZS 106	
1.1	1.1	34	10.84–10.88	C1E 752/C1E 750/C1E 754	4	ZS 106	
1.4	1.4	43	10.84–06.88	C1J 780/C1J 768	4	ZS 251	
1.4	1.4	43	10.84–06.88	C1J 780/C1J 768	4	ZS 316	
1.4	1.4	43	10.85–12.96	C3J 700/C3J 702/C3J 760	4	ZS 251	
1.4	1.4	44	06.87–08.90	C2J 784	4	ZS 251	
1.4	1.4	52	10.84–07.89	C2J 789/C2J 700/C2J 780/C2J 781/ C2J 788/C2J 798	4	ZS 251	
1.7	1.7	54	10.86–03.95	F3N 716 /F3N 717	4	ZS 251	

**THALIA**

1.4	1.4	55	08.00–	K7J 700	4	ZS 354	
1.4 16V	1.4	72	08.00–	K4J 712	4	ZS 052 <sup>282</sup>	GS 29
2.0	2.0	124	09.01–05.05	F4R 738	4	ZS 345	

**TWINGO (C06\_)**

1.2	1.1	40	05.96–10.98	D7F 700/D7F 701	4	ZS 345	
1.2	1.1	40	11.98–	D7F 700/D7F 701	4	ZS 354	
1.2	1.2	40	03.93–10.96	C3G 702/C3G 700	4	ZS 250	
1.2	1.1	43	05.96–10.98	D7F 700/D7F 704/D7F 702/D7F 701/ D7F 703	4	ZS 345	
1.2	1.1	43	11.98–	D7F 700/D7F 702/D7F 704/D7F 701/ D7F 703	4	ZS 354	
1.2 16V	1.1	44	08.04–	D4F 708	4	ZS 325	
1.2 16V	1.1	44	08.04–	D4F 708	4	ZS 354	
1.2 16V	1.1	44	08.04–	D4F 708	4	ZS 375	
1.2 16V	1.1	55	09.04–	D4F 702	4	ZS 354	

**TWINGO (CNO\_)**

1.2	1.1	43	03.07–	D7F 800	4	ZS 354	
1.2 16V	1.1	55	03.07–	D4F 772	4	ZS 325	
1.2 16V	1.1	55	03.07–	D4F 772	4	ZS 375	
1.2 16V	1.1	56	03.07–	D4F 772	4	ZS 325	
1.2 16V	1.1	56	03.07–	D4F 772	4	ZS 375	
1.2 TCe 100	1.1	75	02.11–	D4F 780	4	ZS 354	
1.2 Turbo	1.1	74	03.07–	D4F 780/D4F 782	4	ZS 354	
1.6 RS	1.6	98	05.08–	K4M 854	4	ZS 052 <sup>282</sup>	GS 29

**VEL SATIS**

2.0 16V Turbo	2.0	120	06.02–	F4R 762/F4R 763	4	ZS 052 <sup>282</sup>	GS 29
2.0 16 V Turbo	2.0	125	04.04–	F4R 766/F4R 767	4	ZS 052 <sup>282</sup>	GS 29
3.5 V6	3.5	177	06.02–	V4Y 701/V4Y 711	6	ZS 052 <sup>282</sup>	GS 29

**WIND**

1.2 TCe 100	1.1	75	02.11–	D4F 780	4	ZS 354	
1.6	1.6	98	07.10–	K4M 854	4	ZS 052 <sup>282</sup>	GS 29

**TRAFIC Bus (T5, T6, T7)**

1.7	1.7	50	06.86–04.89	F1N 724	4	ZS 251 <sup>202</sup>	
1.7	1.7	50	06.86–04.89	F1N 724	4	ZS 316 <sup>202</sup>	
2.0	2.0	59	06.86–04.89	J5R 722/J5R 716/J5R 726	4	ZS 251 <sup>202</sup>	
2.0	2.0	59	06.86–04.89	J5R 722/J5R 716/J5R 726	4	ZS 316 <sup>202</sup>	
2.0 4x4	2.0	59	06.86–04.89	J5R 722/J5R 716/J5R 726	4	ZS 251 <sup>202</sup>	
2.0 4x4	2.0	59	06.86–04.89	J5R 722/J5R 716/J5R 726	4	ZS 316 <sup>202</sup>	

**TRAFIC Bus (TXW)**

1.7	1.7	50	08.92–08.94	F1N 724	4	ZS 251 <sup>202</sup>	
1.7	1.7	50	08.92–08.94	F1N 724	4	ZS 316 <sup>202</sup>	
2.0	2.0	59	05.89–08.90	J5R 726	4	ZS 251 <sup>202</sup>	
2.0	2.0	59	05.89–08.90	J5R 726	4	ZS 316 <sup>202</sup>	
2.2	2.2	70	05.89–06.94	J7T 780	4	ZS 251 <sup>202</sup>	
2.2	2.2	70	05.89–06.94	J7T 780	4	ZS 316 <sup>202</sup>	
2.2 4x4	2.2	70	05.89–06.94	J7T 780	4	ZS 251 <sup>202</sup>	



kW

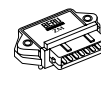

**RENAULT**



**TRAFIC Bus (TXW)**

2.2 4x4	2.2	70	05.89–06.94	J7T 780	4		<b>ZS 316</b> <sup>202</sup>		
<b>TRAFIC II Bus (JL)</b>									
2.0	2.0	88	03.01–	F4R 722/F4R 720	4		<b>ZS 052</b> <sup>202</sup>	<b>GS 29</b>	
2.0 16V	2.0	86	08.06–	F4R 820	4		<b>ZS 052</b> <sup>202</sup>	<b>GS 29</b>	

**ROLLS-ROYCE**

**GHOST**

6.6 V12	6.6	420	12.09–	N74 B66 A	12		<b>ZSE 143</b>	
---------	-----	-----	--------	-----------	----	--	----------------	--

**PHANTOM**

6.75	6.7	338	08.02–02.09	N73 B68 A	12		<b>ZS 324</b>	
------	-----	-----	-------------	-----------	----	--	---------------	--

**PHANTOM Coupe**

6.75 V12	6.7	338	09.08–02.09	N73 B68 A	12		<b>ZS 324</b>	
----------	-----	-----	-------------	-----------	----	--	---------------	--

**PHANTOM DROPHEAD COUPE**

6.75 V12	6.7	338	06.07–02.09	N73 B68 A	12		<b>ZS 324</b>	
----------	-----	-----	-------------	-----------	----	--	---------------	--

**ROVER**

**25**

1.4 16V	1.4	76	10.99–05.05	14 K4F Fgst.Nr.471565→	4		<b>ZS 501</b>	
1.6 16V	1.6	80	10.99–05.05	16 K4F Fgst.Nr.471565→	4		<b>ZS 501</b>	
1.8 16V	1.8	85	10.99–05.05	18 K4F	4		<b>ZS 502</b>	
1.8 16V	1.8	107	02.00–05.05	18 K4K	4		<b>ZS 502</b>	

**45**

1.8	1.8	86	02.00–05.05	18 K4F	4		<b>ZS 502</b>	
2.0 V6	2.0	110	02.00–03.03	20 K4F	6		<b>ZS 435</b> <sup>202</sup>	
2.0 V6	2.0	110	02.00–03.03	20 K4F	6		<b>ZS 437</b> <sup>202</sup>	

**75**

2.0 V6	2.0	110	02.99–03.03	20 K4F	6		<b>ZS 435</b> <sup>202</sup>	
2.0 V6	2.0	110	02.99–03.03	20 K4F	6		<b>ZS 437</b> <sup>202</sup>	
2.5 V6	2.5	129	02.99–10.01	KV 6	6		<b>ZS 088</b>	
2.5 V6	2.5	130	10.01–03.03	25 K4F	6		<b>ZS 435</b> <sup>202</sup>	
2.5 V6	2.5	130	10.01–03.03	25 K4F	6		<b>ZS 437</b> <sup>202</sup>	

**75 Tourer**

2.0 V6	2.0	110	08.01–03.03	20 K4F	6		<b>ZS 435</b> <sup>202</sup>	
2.0 V6	2.0	110	08.01–03.03	20 K4F	6		<b>ZS 437</b> <sup>202</sup>	
2.5 V6	2.5	130	08.01–05.05	KV 6	6		<b>ZS 088</b>	

**200 (RF)**

214 Si	1.4	76	11.95–03.00	14 K4F	4		<b>ZS 115</b>	
214 Si	1.4	76	11.95–03.00	14 K4F	4		<b>ZS 501</b>	
218 K Vi	1.8	107	11.95–03.00	18 K4K	4		<b>ZS 502</b>	

**200 Coupe (XW)**

216	1.6	90	10.92–06.99	D 16 A8	4		<b>ZS 276</b>	
-----	-----	----	-------------	---------	---	--	---------------	--

**200 Hatchback (XW)**

216 GSi	1.6	82	10.89–10.95	D 16 Z2	4	<b>ZM 023</b>	<b>ZS 276</b>	
216 GTi	1.6	90	09.90–10.95	D 16 A8	4		<b>ZS 276</b>	

**400 (RT)**

416 Si	1.6	82	01.96–03.00	16 K4F Automatik	4	<b>ZM 044</b>		
416 Si	1.6	82	05.95–03.00	16 K4F Fgst.Nr.74465→	4		<b>ZS 532</b> <sup>206</sup>	
416 Si	1.6	83	01.96–03.00	D 16 Y2 Automatik	4	<b>ZM 044</b>		
416 Si	1.6	83	05.95–03.00	D 16 Y2 Fgst.Nr.74465→	4		<b>ZS 532</b> <sup>206</sup>	

**400 (XW)**

416 GSi	1.6	82	04.90–04.95	D 16 Z2	4		<b>ZS 276</b>	
416 GTi	1.6	90	04.90–04.95	D 16 A8	4		<b>ZS 276</b>	



kW

**ROVER**

<b>400 Tourer</b>							
1.6 i	1.6	82	05.94–11.98	D 16 Z2	4		<b>ZS 532<sup>286</sup></b>
1.6 i	1.6	90	05.94–11.98	D 16 A8	4		<b>ZS 532<sup>286</sup></b>
1.8 i	1.8	107	06.96–11.98	18 K4K	4		<b>ZS 502</b>
<b>600</b>							
618 i/Si	1.9	85	03.96–02.99	F 18 A3 Fgst.Nr.246797→	4	<b>ZM 044</b>	<b>ZS 532</b>
620 i	2.0	85	01.96–06.96	F 20 Z2	4	<b>ZM 044</b>	
620 i	2.0	85	08.93–06.96	F 20 Z2	4		<b>ZS 275</b>
620 i	2.0	85	08.93–06.96	F 20 Z2 Fgst.Nr.246797→	4		<b>ZS 532</b>
620 Si	2.0	96	01.96–02.99	F 20 Z1	4	<b>ZM 044</b>	
620 Si	2.0	96	08.93–02.99	F 20 Z1	4		<b>ZS 275</b>
620 Si	2.0	96	08.93–02.99	F 20 Z1 Fgst.Nr.246797→	4		<b>ZS 532</b>
620 Ti Vitesse	2.0	147	07.94–02.99	20 T4G	4	<b>ZM 044</b>	<b>ZS 275</b>
623 Si	2.3	116	08.93–02.99	H 23 A3	4		<b>ZS 275</b>
<b>2000-3500 Hatchback (SD1)</b>							
2300	2.4	88	01.84–10.86		6	<b>ZM 047</b>	
2600 S	2.6	93	01.84–10.86	12 C/13 C	6	<b>ZM 047</b>	
3500 Vitesse	3.5	142	01.85–10.86	31 A/30 A	8	<b>ZM 047</b>	
<b>CABRIOLET (XW)</b>							
216 1.6i	1.6	90	01.92–11.99	D 16 A8	4		<b>ZS 276</b>
<b>MINI MK I</b>							
1000	1.0	30	01.92–06.93	99 HD 81	4		<b>ZS 106</b>
1300	1.3	37	04.92–10.96	12 A2L Fgst.Nr.BD 134455→	4		<b>ZS 231</b>
1300	1.3	46	01.92–11.00	12 A2E/12 A2L Fgst.Nr.BD 134455→	4		<b>ZS 231</b>

**SAAB**

<b>9-3</b>							
1.8 i	1.8	90	01.04–	Z 18 XE	4		<b>ZS 342</b>
2.0 i	2.0	96	02.98–08.00	B204I	4		<b>ZS 127</b>
2.0 SE Turbo	2.0	147	02.98–08.00	B204R	4		<b>ZS 127</b>
2.0 Turbo	2.0	110	01.01–09.02	B205E	4		<b>ZS 127</b>
2.0 Turbo	2.0	113	10.98–08.00	B204E	4		<b>ZS 127</b>
2.0 Turbo	2.0	136	02.98–08.00	B205L/B204L	4		<b>ZS 127</b>
2.0 Turbo	2.0	151	10.99–08.00	B205R	4		<b>ZS 127</b>
2.3 i	2.3	110	02.98–08.00	B234I	4		<b>ZS 127</b>
2.3 Turbo	2.3	165	10.98–08.00	B235R	4		<b>ZS 127</b>
<b>9-3 Cabriolet</b>							
2.0 i	2.0	96	02.98–08.00	B204I	4		<b>ZS 127</b>
2.0 SE Turbo	2.0	147	02.98–08.00	B204R	4		<b>ZS 127</b>
2.0 Turbo	2.0	110	01.01–08.03	B205E	4		<b>ZS 127</b>
2.0 Turbo	2.0	113	10.98–08.00	B204E	4		<b>ZS 127</b>
2.0 Turbo	2.0	136	02.98–08.00	B205L/B204L	4		<b>ZS 127</b>
2.0 Turbo	2.0	151	10.99–08.00	B205R	4		<b>ZS 127</b>
2.3 i	2.3	110	02.98–08.00	B234I	4		<b>ZS 127</b>
<b>9-3 Kombi</b>							
1.8 i	1.8	90	03.05–	Z 18 XE	4		<b>ZS 342</b>
<b>9-5</b>							
2.0 Turbo SE	2.0	141	10.98–07.00	B205E	4		<b>ZS 127</b>
<b>9-7X</b>							
4.2	4.2	213	12.05–		6		<b>ZSE 133</b>
<b>90</b>							
2.0	2.0	74	08.84–08.87	B 20 I	4	<b>ZM 002</b>	<b>ZS 121</b>
<b>99</b>							
2.0 GL	2.0	74	09.81–12.84	B 20 I/B 20 C	4	<b>ZM 002</b>	
2.0 GL	2.0	74	09.83–12.84	B 20 I/B 20 C	4		<b>ZS 121</b>
<b>900 I</b>							
2.0 -16	2.0	93	01.89–02.90	B202I	4	<b>ZM 015</b>	
2.0 -16	2.0	93	03.90–12.93	B202I	4	<b>ZM 029</b>	



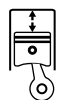

kW

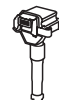

## SAAB

## 900 I

2.0 c	2.0	74	07.82-08.88	B201XC/B 20	4	ZM 002	
2.0 c	2.0	74	09.88-12.88	B201XC/B 20	4	ZM 012	
2.0 c	2.0	74	09.83-12.88	B201XC/B 20	4		ZS 121
2.0 c	2.0	79	09.83-08.84	B20T/BT 20	4	ZM 002	ZS 121
2.0 i	2.0	81	09.85-08.88	B201	4	ZM 002	
2.0 i	2.0	81	09.85-08.90	B201	4	ZM 012	ZS 121
2.0 i	2.0	85	09.81-08.88	BI 20/B201XI	4	ZM 002	
2.0 i	2.0	85	09.88-08.90	BI 20/B201XI	4	ZM 012	
2.0 i	2.0	85	09.83-08.90	BI 20/B201XI	4		ZS 121
2.0 S Turbo-16	2.0	107	01.92-12.93	B202S	4	ZM 012	
2.0 Turbo	2.0	103	10.86-08.88	B201XL	4	ZM 002	
2.0 Turbo	2.0	103	09.88-12.91	B201XL	4	ZM 012	
2.0 Turbo	2.0	107	09.81-07.85	B201S/BSI 20	4	ZM 002	
2.0 Turbo	2.0	107	10.80-07.85	B201S	4		ZS 121
2.0 Turbo	2.0	110	01.86-08.88	B201XL	4	ZM 002	
2.0 Turbo	2.0	110	09.88-12.88	B201XL	4	ZM 012	
2.0 Turbo-16	2.0	118	11.85-08.88	B202XL	4	ZM 002	
2.0 Turbo-16	2.0	118	09.88-12.93	B202XL	4	ZM 012	
2.0 Turbo-16	2.0	118	11.85-12.93	B202XL	4		ZS 121
2.0 Turbo-16 S	2.0	129	09.88-12.88	B202XL	4	ZM 012	
2.0 Turbo-16 S	2.0	129	01.84-12.88	B202XL	4	ZM 002	ZS 121
2.0 Turbo-16 S KAT	2.0	129	01.89-12.93	B202XL	4	ZM 012	
2.0 Turbo-16 S KAT	2.0	129	01.89-12.93	B202XL	4		ZS 121
2.1 -16	2.1	100	08.90-12.93	B212I	4	ZM 001 <sup>202</sup>	
2.1 -16	2.1	100	08.90-12.93	B212I	4	ZM 015 <sup>202</sup>	
2.1 -16	2.1	100	08.90-12.93	B212I	4		ZS 121 <sup>202</sup>

## 900 I Cabriolet

2.0 -16	2.0	93	01.90-06.94	B202I	4	ZM 029	
2.0 Turbo-16	2.0	118	09.88-06.94	B202XL	4	ZM 012	
2.0 Turbo-16	2.0	118	11.86-06.94	B202XL	4		ZS 121
2.0 Turbo-16	2.0	118	11.86-08.88	B202XL	4	ZM 002	
2.0 Turbo-16 S	2.0	129	09.88-06.94	B202XL	4	ZM 012	
2.0 Turbo-16 S	2.0	129	11.86-06.94	B202XL	4		ZS 121
2.0 Turbo-16 S	2.0	129	11.86-08.88	B202XL	4	ZM 002	
2.1 -16	2.1	100	08.90-06.94	B212I	4	ZM 001	ZS 121 <sup>202</sup>
2.1 -16	2.1	100	08.90-06.94	B212I	4	ZM 015	ZS 121 <sup>202</sup>

## 900 I Combi Coupe

2.0 -16	2.0	93	01.89-02.90	B202I	4	ZM 015	
2.0 -16	2.0	93	03.90-08.92	B202I	4	ZM 029	
2.0 c	2.0	74	09.81-08.88	B201XC/B 20	4	ZM 002	
2.0 c	2.0	74	09.88-12.88	B201XC/B 20	4	ZM 012	
2.0 c	2.0	74	09.83-12.88	B201XC/B 20	4		ZS 121
2.0 c	2.0	79	09.78-08.84	B20T/BT 20	4	ZM 002	
2.0 c	2.0	79	09.83-08.84	B20T/BT 20	4		ZS 121
2.0 i	2.0	81	09.85-08.88	B201	4	ZM 002	
2.0 i	2.0	81	09.88-08.90	B201	4	ZM 012	
2.0 i	2.0	81	09.85-08.90	B201	4		ZS 121
2.0 i	2.0	85	11.80-08.88	BI 20/B201XI	4	ZM 002	
2.0 i	2.0	85	09.88-12.88	BI 20/B201XI	4	ZM 012	
2.0 i	2.0	85	09.83-12.88	BI 20/B201XI	4		ZS 121
2.0 Turbo	2.0	103	10.86-08.88	B201XL	4	ZM 002	
2.0 Turbo	2.0	103	09.88-12.91	B201XL	4	ZM 012	
2.0 Turbo	2.0	107	09.81-07.85	B201S	4	ZM 002	ZS 121
2.0 Turbo	2.0	110	01.86-08.88	B201XL	4	ZM 002	
2.0 Turbo	2.0	110	09.88-12.88	B201XL	4	ZM 012	
2.0 Turbo-16	2.0	118	09.88-06.94	B202XL	4	ZM 012	
2.0 Turbo-16	2.0	118	11.85-06.94	B202XL	4		ZS 121
2.0 Turbo-16	2.0	118	11.85-08.88	B202XL	4	ZM 002	
2.0 Turbo-16	2.0	132	01.93-06.94	B202L	4	ZM 012	ZS 121
2.0 Turbo-16 S	2.0	129	09.88-12.88	B202XL	4	ZM 012	
2.0 Turbo-16 S	2.0	129	02.84-12.88	B202XL	4	ZM 002	ZS 121

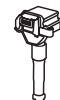

kW

**SAAB****900 I Combi Coupe**

2.0 Turbo-16 S KAT	2.0	125	01.89-12.93	B202XL	4	<b>ZM 012</b>	<b>ZS 121</b>
2.1 -16	2.1	100	09.90-07.93	B212I	4	<b>ZM 015</b>	<b>ZS 121</b>

**900 II**

2.0 -16 Turbo	2.0	136	07.93-02.98	B204L	4		<b>ZS 127</b>
2.0 i	2.0	96	08.94-02.98	B204I	4		<b>ZS 127</b>
2.0 i	2.0	98	07.93-07.94	B206I	4		<b>ZS 127</b>
2.3 -16	2.3	110	07.93-02.98	B234I	4		<b>ZS 127</b>
2.5 -24 V6	2.5	125	07.93-08.95	B258I	6		<b>ZS 301</b>

**900 II Cabriolet**

2.0 -16 Turbo	2.0	136	12.93-02.98	B204L	4		<b>ZS 127</b>
2.0 i	2.0	96	12.93-02.98	B204I	4		<b>ZS 127</b>
2.3 -16	2.3	110	12.93-02.98	B234I	4		<b>ZS 127</b>
2.5 -24 V6	2.5	125	12.93-08.95	B258I	6		<b>ZS 301</b>

**900 II Coupe**

2.0 -16 Turbo	2.0	136	12.93-02.98	B204L	4		<b>ZS 127</b>
2.0 i	2.0	96	08.94-02.98	B204I	4		<b>ZS 127</b>
2.0 i	2.0	98	12.93-07.94	B206I	4		<b>ZS 127</b>
2.3 -16	2.3	110	12.93-02.98	B234I	4		<b>ZS 127</b>
2.5 -24 V6	2.5	125	12.93-08.95	B258I	6		<b>ZS 301</b>

**9000**

2.0 -16	2.0	94	09.89-01.93	B202I	4		<b>ZS 121</b>
2.0 -16 Turbo	2.0	118	05.88-08.93	B202XL	4	<b>ZM 002</b>	<b>ZS 121</b>
2.0 -16 Turbo	2.0	129	04.85-12.91	B202XL	4	<b>ZM 002</b>	<b>ZS 121</b>
2.0 -16 Turbo CD	2.0	120	09.88-08.93	B202XL	4		<b>ZS 121</b>
2.0 -16 Turbo CD	2.0	136	09.89-08.92	B202L	4		<b>ZS 121</b>
2.3 -16 CD	2.3	107	08.89-08.93	B234I	4		<b>ZS 121</b>

**9000 Schrägheck**

2.0 -16	2.0	92	12.85-12.88	B202XI	4	<b>ZM 015</b>	<b>ZS 121</b>
2.0 -16	2.0	94	12.85-08.88	B202XI	4	<b>ZM 015</b>	<b>ZS 121</b>
2.0 -16 Turbo	2.0	118	09.84-08.93	B202XL	4		<b>ZS 121</b>
2.0 -16 Turbo	2.0	120	05.88-08.93	B202XL	4		<b>ZS 121</b>
2.0 -16 Turbo	2.0	127	06.89-12.92	B202	4		<b>ZS 121</b>
2.0 -16 Turbo	2.0	129	09.84-12.91	B202XL	4		<b>ZS 121</b>
2.0 -16 Turbo CS	2.0	136	09.88-08.92	B202L	4		<b>ZS 121</b>
2.3 -16 Aero CS	2.3	162	02.93-08.93	B234R	4		<b>ZS 121</b>
2.3 -16 Aero CS	2.3	165	02.93-08.93	B234R	4		<b>ZS 121</b>
2.3 -16 CS	2.3	107	09.89-08.93	B234I	4		<b>ZS 121</b>
2.3 -16 Turbo	2.3	143	09.90-08.93	B234L	4		<b>ZS 121</b>

**SEAT****ALHAMBRA (7V8, 7V9)**

1.8 T 20V	1.8	110	10.97-03.10	AWC/AJH	4	<b>ZM 062</b>	
1.8 T 20V	1.8	110	10.97-03.10	AJH	4		<b>ZS 016</b> <b>ZLE 276</b>
1.8 T 20V	1.8	110	10.97-03.10	AJC	4		<b>ZSE 009</b>
2.0 i	2.0	85	04.96-03.10	ATM	4	<b>ZM 013</b>	<b>ZSE 003</b>
2.8 V6	2.8	150	06.00-03.10	AYL/AUE	6		<b>ZSE 063</b>
2.8 V6 4motion	2.8	150	06.00-03.10	AYL/AUE	6		<b>ZSE 063</b>

**ALHAMBRA (710)**

1.4 TSI	1.4	110	06.10-	CAVA , CNWB	4		<b>ZSE 030</b>
2.0 TSI	2.0	147	11.10-	CCZA	4		<b>ZSE 033</b> <sup>202</sup>
2.0 TSI	2.0	147	11.10-	CCZA	4		<b>ZSE 142</b> <sup>202</sup>

**ALTEA**

1.2 TSI	1.2	77	04.10-	CBZB	4		<b>ZSE 003</b>
1.4 16V	1.4	63	05.06-	BXW	4		<b>ZSE 030</b>
1.4 TSI	1.4	92	11.07-	CAXC	4		<b>ZSE 030</b>
1.6	1.6	75	03.04-	BGU/CCSA/BSF/CMXA/BSE	4		<b>ZSE 003</b>
1.6 LPG	1.6	75	09.09-	CHGA	4		<b>ZSE 003</b>
1.8 TFSI	1.8	118	01.07-	BZB/CDA/AYT	4		<b>ZSE 033</b> <sup>202</sup>
1.8 TFSI	1.8	118	01.07-	BZB/CDA/AYT	4		<b>ZSE 142</b> <sup>202</sup>
2.0 FSI	2.0	110	05.04-03.09	BLR/BLY/BVZ/BVY	4		<b>ZSE 033</b> <sup>202</sup>
2.0 FSI	2.0	110	05.04-03.09	BLR/BLY/BVZ/BVY	4		<b>ZSE 142</b> <sup>202</sup>



kW



## SEAT

## ALTEA

2.0 TFSI	2.0	147	04.06–05.09	BWA	4		ZSE 033 <sup>202</sup>
2.0 TFSI	2.0	147	04.06–05.09	BWA	4		ZSE 142 <sup>202</sup>

## ALTEA XL

1.2 TSI	1.2	77	04.10–	CBZB	4		ZSE 003
1.4 16V	1.4	63	10.06–	BXW	4		ZSE 030
1.4 TSI	1.4	92	11.07–	CAXC	4		ZSE 030
1.6	1.6	75	10.06–	CCSA/BSF/CMXA/BSE	4		ZSE 003
1.6 LPG	1.6	75	09.09–	CHGA	4		ZSE 003
1.6 Multifuel	1.6	75	10.06–	CCSA	4		ZSE 003
1.8 TFSI	1.8	118	01.07–	BZB/CDAABYB	4		ZSE 033
2.0 FSI	2.0	110	10.06–03.09	BVZ/BVY	4		ZSE 033 <sup>202</sup>
2.0 FSI	2.0	110	10.06–03.09	BVZ/BVY	4		ZSE 142 <sup>202</sup>
2.0 TFSI 4x4	2.0	147	06.07–05.09	BWA	4		ZSE 033 <sup>202</sup>
2.0 TFSI 4x4	2.0	147	06.07–05.09	BWA	4		ZSE 142 <sup>202</sup>
2.0 TFSI 4x4	2.0	155	05.09–	CCZB	4		ZSE 033 <sup>202</sup>
2.0 TFSI 4x4	2.0	155	05.09–	CCZB	4		ZSE 142 <sup>202</sup>

## AROSA

1.0	1.0	37	10.98–02.00	AHT	4		ZSE 040
1.0	1.0	37	05.97–06.04	ALD, ANV, AUC	4		ZSE 003 <sup>202</sup>
1.0	1.0	37	05.97–06.04	AER/ANV/ALD/ALL/AUC	4		ZSE 040 <sup>202</sup>
1.4	1.4	44	05.97–06.04	AEX, AKV, APQ	4		ZSE 001
1.4	1.4	44	05.97–06.04	ANW, AKK, AUD	4		ZSE 003
1.4 16V	1.4	74	01.00–06.04	AFK, ANM, AUB	4		ZSE 003

## CORDOBA (6K1, 6K2)

1.4 i	1.4	44	06.94–06.99	ABD	4	ZM 013	ZSE 001
1.4 i 16V	1.4	74	09.96–06.99	AFH	4		ZSE 001
1.6 i	1.6	55	02.93–06.99	ABU	4	ZM 013	
1.6 i	1.6	55	02.93–06.99	ABU/ALM/AEE	4		ZSE 001
1.6 i	1.6	74	07.96–10.99	AKL/AFT	4		ZSE 001
1.8 i	1.8	66	02.93–06.99	ABS	4	ZM 013	ZSE 001
1.8 i 16V	1.8	95	10.93–08.96	ADL Fgst.Nr.→6K-ZR132108,6K-ZR671	4		ZSE 002
1.8 i 16V	1.8	95	10.93–08.96	ADL Fgst.Nr.6K-ZR132109,6K-ZR672→	4		ZSE 001
2.0 i	2.0	85	02.93–06.99	2E	4		ZSE 001
2.0 i 16V	2.0	110	08.96–06.99	ABF	4		ZSE 001

## CORDOBA (6K2)

1.0	1.0	37	06.99–10.02	ANV, ALD, AUC	4		ZSE 003
1.4	1.4	44	06.99–10.02	ANW, AKK	4		ZSE 003
1.4 16V	1.4	55	05.00–10.02	APE/AUA	4		ZSE 003
1.4 16V	1.4	74	02.00–10.02	AUB	4		ZSE 003
1.6	1.6	55	06.99–10.02	ALM	4		ZSE 001
1.6	1.6	74	10.99–09.01	AEH, AKL, APF, AUR	4		ZSE 003
1.8 T 20V Cupra	1.8	115	07.00–10.02	AQX	4		ZSE 009
1.8 T 20V Cupra	1.8	115	07.00–10.02	AYP	4		ZSE 043

## CORDOBA (6L2)

1.2	1.2	47	10.02–06.06	AZQ, BME	3		ZSE 030
1.2 12V	1.2	51	05.06–11.09	BXV	3		ZSE 030
1.4 16V	1.4	55	09.02–12.07	BBY/BKY	4		ZSE 030
1.4 16V	1.4	63	05.06–11.09	BXW	4		ZSE 030
1.4 16V	1.4	74	10.02–11.09	BBZ/AUB	4		ZSE 030
1.6	1.6	74	04.03–11.09	BAH	4		ZSE 003
1.6 16V	1.6	77	11.06–11.09	BTS	4		ZSE 030
2.0	2.0	85	09.02–11.09	AZL/BBX	4		ZSE 003

## CORDOBA Vario (6K5)

1.4	1.4	44	06.99–12.02	ANW, AKK	4		ZSE 003
1.4	1.4	74	02.00–12.02	AUB	4		ZSE 003
1.4 16V	1.4	55	06.99–12.02	APE/AUA	4		ZSE 003
1.4 i	1.4	44	09.96–06.99	AEX/AKV/APQ	4		ZSE 001
1.6	1.6	55	06.99–12.02	ALM	4		ZSE 001
1.6	1.6	74	10.99–10.02	APF, AUR	4		ZSE 003



kW



## SEAT

## CORDOBA Vario (6K5)

1.6	1.6	74	10.99–10.02	AEH	4		ZSE 003
1.6	1.6	74	10.99–09.01	AKL	4		ZSE 003
1.6 i	1.6	55	09.96–06.99	ALM/AEE	4		ZSE 001
1.6 i	1.6	74	09.96–06.99	AFT	4		ZSE 001

## EXEO (3R2)

1.6	1.6	75	03.09–09.10	ALZ	4		ZSE 003
1.8 T	1.8	110	12.08–05.10	CFMA	4		ZSE 003
1.8 T	1.8	110	12.08–05.10	CFMA	4		ZSE 043
1.8 TSI	1.8	88	09.10–	CDHA	4		ZSE 033
1.8 TSI	1.8	118	05.10–	CDHB	4		ZSE 142 <sup>202</sup>
1.8 TSI	1.8	118	05.10–	CDHB	4		ZSE 033 <sup>202</sup>
2.0 TFSI	2.0	147	03.09–	BWE	4		ZSE 033 <sup>202</sup>
2.0 TFSI	2.0	147	03.09–	BWE	4		ZSE 142 <sup>202</sup>
2.0 TFSI	2.0	155	05.10–	CDND	4		ZSE 033 <sup>202</sup>
2.0 TFSI	2.0	155	05.10–	CDND	4		ZSE 142 <sup>202</sup>

## EXEO ST (3R5)

1.6	1.6	75	06.09–09.10	ALZ	4		ZSE 003
1.8 T	1.8	110	06.09–05.10	CFMA	4		ZSE 003 <sup>202</sup>
1.8 T	1.8	110	06.09–05.10	CFMA	4		ZSE 043 <sup>202</sup>
1.8 TSI	1.8	88	09.10–	CDHA	4		ZSE 033
1.8 TSI	1.8	118	05.10–	CDHB	4		ZSE 033 <sup>202</sup>
1.8 TSI	1.8	118	05.10–	CDHB	4		ZSE 142 <sup>202</sup>
2.0 TFSI	2.0	147	06.09–	BWE	4		ZSE 033 <sup>202</sup>
2.0 TFSI	2.0	147	06.09–	BWE	4		ZSE 142 <sup>202</sup>
2.0 TFSI	2.0	155	05.10–	CDND	4		ZSE 033 <sup>202</sup>
2.0 TFSI	2.0	155	05.10–	CDND	4		ZSE 142 <sup>202</sup>

## IBIZA I

0.9	0.9	29	08.90–05.93	146 A 000/09 NCA	4		ZS 106
0.9	0.9	32	08.86–05.93	146 A 000	4	ZM 002	
1.2	1.2	44	11.84–12.93	021 A 1000	4	ZM 002	ZS 120
1.2 i	1.2	52	01.89–03.91	021 C.1000	4	ZM 015	ZS 120
1.5	1.5	63	11.84–05.93	021 A 2000	4	ZM 002	
1.5 i	1.5	65	10.86–03.91	021 D.2000	4	ZM 015	
1.5 i	1.5	65	11.89–03.91	021 D.2000	4		ZS 120
1.5 i	1.5	74	10.86–03.91	021 B.2000	4	ZM 015	ZS 120
1.5 i KAT	1.5	66	10.86–03.91	021 C.2000	4	ZM 015	ZS 120
1.7	1.7	72	01.91–03.91	021 A.3000	4	ZM 015	ZS 120
1.7	1.7	76	01.91–03.91	021 B.3000	4	ZM 015	ZS 120

## IBIZA II

1.0	1.0	33	03.93–09.96	AAU	4	ZM 013	ZSE 001
1.0 i	1.0	37	09.96–08.99	AER	4		ZSE 001
1.3 i	1.3	40	03.93–08.99	AAV	4	ZM 013	ZSE 001
1.3 i	1.3	40	03.93–08.99	2G	4	ZM 013	ZSE 002
1.4 i	1.4	44	09.93–08.99	AEX/AKV/ABD/APQ	4	ZM 013	ZSE 001
1.4 i 16V	1.4	74	06.97–08.99	AFH	4		ZSE 001
1.6 i	1.6	55	03.93–08.99	ABU/ALM/AEE	4		ZSE 001
1.6 i	1.6	74	04.96–08.99	AFT	4		ZSE 001
1.8 i	1.8	66	03.93–08.99	ABS	4		
1.8 i	1.8	66	03.93–08.99	ACC/ADZ/ABS	4	ZM 013	ZSE 002
1.8 i 16V	1.8	95	11.93–08.96	ADL	4		ZSE 001
2.0 i	2.0	85	03.93–08.99	2E	4	ZM 013	
2.0 i	2.0	85	03.93–08.99	2E/AGG	4		ZSE 002
2.0 i 16V	2.0	110	08.96–08.99	ABF	4		ZSE 001

## IBIZA III

1.0	1.0	37	08.99–02.02	ANV, ALD, AUC	4		ZSE 003
1.4	1.4	44	08.99–02.02	ANW, AKK, AUD	4		ZSE 003
1.4 16V	1.4	55	05.00–02.02	APE, AUA	4		ZSE 003
1.4 16V	1.4	74	08.99–02.02	AUB	4		ZSE 003
1.6	1.6	55	08.99–02.02	ALM	4		ZSE 001
1.6	1.6	74	08.99–02.02	AKL/APF/AEH/AUR	4		ZSE 003



kW



SEAT							
<b>IBIZA IV</b>							
1.2	1.2	44	06.07–05.08	BBM	3		ZSE 059
1.2	1.2	47	02.02–06.06	AZQ/BME	3		ZSE 030
1.2 12V	1.2	51	05.06–11.09	BXV	3		ZSE 030
1.4 16V	1.4	55	02.02–12.07	BBY/BKY	4		ZSE 030
1.4 16V	1.4	63	05.06–11.09	BXW	4		ZSE 030
1.4 16V	1.4	74	02.02–11.09	AUB	4		ZSE 003
1.4 16V	1.4	74	02.02–11.09	BBZ	4		ZSE 030
1.6	1.6	74	02.03–11.09	BAH	4		ZSE 003
1.6 16V	1.6	77	11.06–11.09	BTS	4		ZSE 030
1.8 T Cupra R	1.8	132	01.04–02.08	BBU/BLZ	4		ZSE 043
1.8 T FR	1.8	110	12.03–05.08	BJX	4		ZSE 043
2.0	2.0	85	04.02–11.09	AZL/BBX	4		ZSE 003
<b>IBIZA V</b>							
1.2	1.2	44	07.09–	CGPB	3		ZSE 030
1.2	1.2	51	03.08–	BZG/CGPA	3		ZSE 030
1.2 TSI	1.2	77	09.10–	CBZB	4		ZSE 003
1.4	1.4	63	03.08–	BXW , CGGB	4		ZSE 030
1.6	1.6	77	05.08–	BTS	4		ZSE 030
1.6 LPG	1.6	60	05.11–	CNKA	4		ZSE 030
<b>IBIZA V SPORTCOUPE</b>							
1.2	1.2	44	07.09–	CGPB	3		ZSE 030
1.2	1.2	51	07.08–	BZG/CGPA	3		ZSE 030
1.2 TSI	1.2	77	09.10–	CBZB	4		ZSE 003
1.4	1.4	63	07.08–	CGGB/BXW	4		ZSE 030
1.6 LPG	1.6	60	05.11–	CNKA	4		ZSE 030
1.6	1.6	77	07.08–	BTS	4		ZSE 030
<b>IBIZA V ST</b>							
1.2	1.2	44	05.10–	CGPB	3		ZSE 030
1.2	1.2	51	05.10–	CGPA	3		ZSE 030
1.2 TSI	1.2	77	09.10–	CBZB	4		ZSE 003
1.4	1.4	63	03.10–	CGGB	4		ZSE 030
<b>INCA</b>							
1.4 16V	1.4	55	04.00–06.03	AUA	4		ZSE 003
1.4 i	1.4	44	11.95–06.03	AEX, AKV, APQ	4		ZSE 001
1.4 i	1.4	44	11.95–06.03	AUD	4		ZSE 003
1.6 i	1.6	55	11.95–05.98	1F	4		ZSE 001
<b>LEON (1M1)</b>							
1.4 16V	1.4	55	11.99–06.06	APE , AHW , AXP	4		ZSE 003
1.4 16V	1.4	55	11.99–06.06	BCA	4		ZSE 030
1.6	1.6	74	11.99–06.06	AEH , AKL	4		ZSE 003
1.6	1.6	75	10.05–06.06	BFQ	4		ZSE 003
1.6 16 V	1.6	77	09.00–06.06	AUS	4		ZSE 003
1.6 16 V	1.6	77	09.00–06.06	AZD , BCB	4		ZSE 030
1.8 20V	1.8	92	11.99–06.06	AGN/APG	4		ZSE 003
1.8 20V T	1.8	132	11.99–06.06	APP	4	ZM 062	ZSE 009
1.8 20V T	1.8	132	11.99–06.06	AUQ	4		ZSE 043
1.8 20V T 4	1.8	132	11.99–06.06	AJQ	4		ZS 016 ZLE 276
1.8 T Cupra R	1.8	154	02.02–06.06	AMK	4		ZSE 043
1.8 T Cupra R	1.8	165	07.03–06.06	BAM	4		ZSE 043
1.8 Turbo 4x4	1.8	154	05.02–05.03	AMK	4		ZSE 043
2.8 Cupra 4	2.8	150	02.01–06.06	AUE	6		ZSE 013
<b>LEON (1P1)</b>							
1.2 TSI	1.2	77	02.10–	CBZB	4		ZSE 003
1.4 16V	1.4	63	06.06–	BXW , CGGB	4		ZSE 030
1.4 TSI	1.4	92	11.07–	CAXC	4		ZSE 030
1.6	1.6	75	07.05–	BSE, BSF , CCSA, CMXA	4		ZSE 003
1.8 TSI	1.8	118	06.07–	BZB/CDAA	4		ZSE 033 <sup>202</sup>
1.8 TSI	1.8	118	06.07–	BZB/CDAA	4		ZSE 142 <sup>202</sup>
2.0 Cupra R	2.0	195	09.09–	CDLA	4		ZSE 033
2.0 FSI	2.0	110	07.05–05.10	BLR/BLY/BVZ/BVY	4		ZSE 033 <sup>202</sup>
2.0 FSI	2.0	110	07.05–05.10	BLR/BLY/BVZ/BVY	4		ZSE 142 <sup>202</sup>



kW



SEAT							
<b>LEON (1P1)</b>							
2.0 TFSI	2.0	136	09.05–05.06	BWA1	4		ZSE 142 <sup>202</sup>
2.0 TFSI	2.0	136	09.05–05.06	BWA1	4		ZSE 033 <sup>202</sup>
2.0 TFSI	2.0	147	05.05–03.09	BWA	4		ZSE 033 <sup>202</sup>
2.0 TFSI	2.0	147	05.05–03.09	BWA	4		ZSE 142 <sup>202</sup>
2.0 TFSI	2.0	155	06.09–	CCZB	4		ZSE 033 <sup>202</sup>
2.0 TFSI	2.0	155	06.09–	CCZB	4		ZSE 142 <sup>202</sup>
2.0 TFSI	2.0	177	11.06–	BWJ/CDLD	4		ZSE 033 <sup>202</sup>
2.0 TFSI	2.0	177	11.06–	BWJ/CDLD	4		ZSE 142 <sup>202</sup>
<b>LEON (5F.)</b>							
1.8 TFSI	1.8	132	02.13–	CJSA	4		ZSE 068
<b>MALAGA</b>							
1.2	1.2	44	05.85–12.93	021 A 1000	4	ZM 002	
1.2 i	1.2	52	12.89–03.91	021 C.1000	4	ZM 015	ZS 120
1.5	1.5	63	05.85–12.93	021 A 2000	4	ZM 002	
1.5 i	1.5	74	01.87–03.91	021 B.2000	4	ZM 015	ZS 120
1.5 i KAT	1.5	66	10.86–03.91	021 A 2000/021 C.2000/021 D.2000	4	ZM 015	ZS 120
<b>MARBELLA</b>							
0.8	0.8	25	08.86–12.93	08 NCA	4		ZS 106 <sup>288</sup>
0.9	0.9	29	01.87–12.93	100 GL 7000/09 NCA	4		ZS 106 <sup>288</sup>
0.9 KAT	0.9	29	01.90–12.90	100 GL 7000/09 NCB	4		ZS 106 <sup>288</sup>
0.9 KAT	0.9	30	11.96–10.98	08 NCB	4		ZS 327
<b>Mii</b>							
1.0	1.0	44	10.11–	CHYA	3		ZSE 067 <sup>202</sup>
1.0	1.0	44	10.11–	CHYA	3		ZSE 126 <sup>202</sup>
1.0	1.0	55	10.11–	CHYB	3		ZSE 067 <sup>202</sup>
1.0	1.0	55	10.11–	CHYB	3		ZSE 126 <sup>202</sup>
1.0 EcoFuel	1.0	50	11.12–	CPGA	3		ZSE 067 <sup>202</sup>
1.0 EcoFuel	1.0	50	11.12–	CPGA	3		ZSE 126 <sup>202</sup>
<b>RONDA</b>							
1.2	1.2	47	05.84–05.85	021 A 1000/124 B6.000	4	ZM 002	
1.5	1.5	63	09.84–12.86	021 A 2000	4	ZM 002	
<b>TERRA</b>							
0.9 KAT	0.9	29	02.92–12.94	09 NCB	4		ZS 327
<b>TOLEDO I</b>							
1.6 i	1.6	52	05.91–12.93	1F	4	ZM 012	ZSE 001
1.6 i	1.6	54	05.91–03.99	EZ/ABN/1F Fgst.Nr.1L-ZR001001→	4	ZM 012	ZSE 001
1.6 i	1.6	55	01.93–03.99	1F	4	ZM 012	ZSE 001
1.8 16V	1.8	92	05.91–03.94	PL	4		ZS 124
1.8 16V	1.8	92	05.91–03.99	PL	4	ZM 012	
1.8 16V	1.8	98	05.91–11.92	KR	4		ZS 124
1.8 i	1.8	65	05.91–11.93	RP	4		ZS 124
1.8 i	1.8	65	05.91–12.96	RP	4	ZM 012	
1.8 i	1.8	66	11.93–12.96	ACC/ADZ/ABS Fgst.Nr.1L-ZR001001→	4	ZM 013	ZSE 001
2.0 i	2.0	85	05.91–03.99	2E/AGG Fgst.Nr.→1L-ZR001000	4		ZSE 002
2.0 i	2.0	85	01.93–03.99	2E/AGG Fgst.Nr.1L-ZR001001→	4		ZSE 001
2.0 i 16V	2.0	110	11.93–03.99	ABF Fgst.Nr.→1L-ZR001000	4	ZM 013	ZSE 002
2.0 i 16V	2.0	110	11.93–03.99	ABF Fgst.Nr.1L-ZR0010001→	4		ZSE 001
<b>TOLEDO II</b>							
1.4 16V	1.4	55	07.99–05.06	AHW	4		ZSE 003
1.6	1.6	74	04.99–09.00	AEH , AKL	4		ZSE 003
1.6	1.6	75	08.05–05.06	BFQ	4		ZSE 003
1.6 16V	1.6	77	09.00–05.06	AUS	4		ZSE 003
1.6 16V	1.6	77	09.00–05.06	AZD , BCB	4		ZSE 030
1.8 20V	1.8	92	04.99–05.06	AGN/APG	4		ZSE 003
1.8 20VT	1.8	132	05.01–05.06	APP	4		ZSE 009
1.8 20VT	1.8	132	05.01–05.06	AUQ	4		ZSE 043



kW

**SEAT****TOLEDO II**

1.8 Allrad	1.8	154	05.02–05.03	AMK	4	<b>ZSE 043</b>
1.8 Allrad	1.8	165	05.03–10.05	BAM	4	<b>ZSE 043</b>
2.3 V5	2.3	110	04.99–11.00	AGZ	5	<b>ZS 037</b>
2.8	2.8	150	10.00–07.01	AUE	6	<b>ZSE 013</b>

**TOLEDO III**

1.6	1.6	75	10.04–05.09	BGU/CCSA/BSF/BSE	4	<b>ZSE 003</b>
1.8 TFSI	1.8	118	01.07–05.09	BZB/CDAA/BYT	4	<b>ZSE 033</b>
2.0 FSI	2.0	110	10.04–05.09	BLR/BLY/BVZ/BVY	4	<b>ZSE 033<sup>202</sup></b>
2.0 FSI	2.0	110	10.04–05.09	BLR/BLY/BVZ/BVY	4	<b>ZSE 142<sup>202</sup></b>
2.0 TFSI	2.0	147	11.05–05.09	BWA	4	<b>ZSE 033<sup>202</sup></b>

**TOLEDO III (5P2)**

2.0 TFSI	2.0	147	11.05–05.09	BWA	4	<b>ZSE 142<sup>202</sup></b>
----------	-----	-----	-------------	-----	---	------------------------------

**TOLEDO IV**

1.2	1.2	55	07.12–	CGPC	3	<b>ZSE 030</b>
1.2 TSI	1.2	63	07.12–	CBZA	4	<b>ZSE 003</b>
1.2 TSI	1.2	77	07.12–	CBZB	4	<b>ZSE 003</b>
1.4 TSI	1.4	90	07.12–	CAXA	4	<b>ZSE 030</b>

**SKODA****105,120 (742)**

1.0 105 S,L	1.0	34	08.76–12.90	742,10	4	<b>ZS 106</b>
1.2 120 L	1.2	38	09.79–12.90		4	<b>ZS 109</b>
1.2 120 LS	1.2	43	09.83–12.88	742.12 X	4	<b>ZS 109</b>

**105,120 (744)**

1.0 105 S,L	1.0	32	02.88–12.90	742,10	4	<b>ZS 106</b>
1.0 105 S,L,LS	1.0	33	10.83–12.90	742,10	4	<b>ZS 106</b>
1.2 120 L	1.2	35	08.87–12.90	742,12	4	<b>ZS 109</b>
1.2 120 L	1.2	38	10.83–12.88	742,12	4	<b>ZS 106</b>

**CITIGO**

1.0	1.0	44	10.11–	CHYA	3	<b>ZSE 067<sup>202</sup></b>
1.0	1.0	44	10.11–	CHYA	3	<b>ZSE 126<sup>202</sup></b>
1.0	1.0	55	10.11–	CHYB	3	<b>ZSE 067<sup>202</sup></b>
1.0	1.0	55	10.11–	CHYB	3	<b>ZSE 126<sup>202</sup></b>

**FABIA (6Y2)**

1.0	1.0	37	12.99–08.02	AQV/ARV	4	<b>ZSE 040</b>
1.2	1.2	40	08.02–03.08	AWY/BMD	3	<b>ZSE 059</b>
1.2	1.2	47	01.03–03.08	AZQ , BME	3	<b>ZSE 030</b>
1.4	1.4	44	08.00–08.02	AZF/AZE	4	<b>ZSE 040</b>
1.4	1.4	50	08.99–05.03	AME/ATZ/AQW	4	<b>ZSE 040</b>
1.4 16V	1.4	55	12.99–03.08	BBY/BKY/AUA	4	<b>ZSE 003<sup>202</sup></b>
1.4 16V	1.4	55	12.99–03.08	BBY/BKY/AUA	4	<b>ZSE 030<sup>202</sup></b>
1.4 16V	1.4	55	12.99–03.08	BBY/BKY/AUA	4	<b>ZSE 040<sup>202</sup></b>
1.4 16V	1.4	74	12.99–03.08	BBZ/AUB	4	<b>ZSE 003<sup>202</sup></b>
1.4 16V	1.4	74	12.99–03.08	BBZ/AUB	4	<b>ZSE 030<sup>202</sup></b>
1.4 16V	1.4	74	12.99–03.08	BBZ/AUB	4	<b>ZSE 040<sup>202</sup></b>
2.0	2.0	85	12.99–03.08	AQY/AZL	4	<b>ZSE 003</b>

**FABIA**

1.2	1.2	44	12.06–	BBM/CHFA	3	<b>ZSE 059</b>
1.2	1.2	51	01.07–	CEVA/BZG/CGPA/CHTA	3	<b>ZSE 030</b>
1.2 TSI	1.2	63	03.10–	CBZA	4	<b>ZSE 003</b>
1.2 TSI	1.2	77	03.10–	CBZB	4	<b>ZSE 003</b>
1.4	1.4	63	01.07–	BXW Fgst.Nr.5J-7-000 001→	4	<b>ZSE 030</b>
1.4 TSI	1.4	132	05.10–	CAVE/CTHE	4	<b>ZSE 030</b>
1.6	1.6	77	04.07–	BTS Fgst.Nr.5J-7-000 001→	4	<b>ZSE 030</b>

**FABIA Combi (6Y5)**

1.2	1.2	40	07.01–12.07	AWY/BMD	3	<b>ZSE 059</b>
1.2	1.2	47	01.03–12.07	AZQ , BME	3	<b>ZSE 030</b>
1.4	1.4	44	04.00–03.03	AZF/AZE	4	<b>ZSE 040</b>
1.4	1.4	50	04.00–05.03	AME/ATZ/AQW	4	<b>ZSE 040</b>



kW

**SKODA****FABIA Combi (6Y5)**

1.4 16V	1.4	55	05.00–12.07	BBY/BKY/AUA	4		ZSE 003 <sup>202</sup>
1.4 16V	1.4	55	05.00–12.07	BBY/BKY/AUA	4		ZSE 030 <sup>202</sup>
1.4 16V	1.4	55	05.00–12.07	BBY/BKY/AUA	4		ZSE 040 <sup>202</sup>
1.4 16V	1.4	59	04.06–12.07	BUD	4		ZSE 030
1.4 16V	1.4	74	04.00–12.07	BBZ/AUB	4		ZSE 003 <sup>202</sup>
1.4 16V	1.4	74	04.00–12.07	BBZ/AUB	4		ZSE 030 <sup>202</sup>
1.4 16V	1.4	74	04.00–12.07	BBZ/AUB	4		ZSE 040 <sup>202</sup>
2.0	2.0	85	04.00–12.07	AZL	4		ZSE 003

**FABIA Combi**

1.2	1.2	44	10.07–	BBM/CHFA	3		ZSE 059
1.2	1.2	51	10.07–	CEVA/BZG/CGPA/CHTA	3		ZSE 030
1.2 TSI	1.2	63	03.10–	CBZA	4		ZSE 003
1.2 TSI	1.2	77	03.10–	CBZB	4		ZSE 003
1.4	1.4	63	10.07–	CGGB/BXW Fgst.Nr.→5J-83147 326 , 5J-8A500 601 , 5J-8B502 695	4		ZSE 030
1.4 TSI	1.4	132	05.10–	CAVE/CTHE	4		ZSE 030
1.6	1.6	77	10.07–	BTS/CFNA Fgst.Nr.→5J-83147 326 , 5J-8A500 601 , 5J-8B502 695	4		ZSE 030

**FABIA Praktik**

1.2	1.2	40	07.01–12.07	AWY/BMD	3		ZSE 059
1.2	1.2	47	01.03–12.07	AZQ , BME	3		ZSE 030

**FAVORIT**

1.3	1.3	50	01.94–09.94	136B	4	ZM 060	ZSE 001
1.3 135	1.3	42	12.91–09.94	781.135	4	ZM 060	
1.3 135	1.3	42	07.93–09.94	781.135	4		ZSE 001
1.3 135	1.3	43	12.91–12.93	781.135	4	ZM 060	ZSE 001
1.3 135	1.3	44	10.90–12.93	781.135	4	ZM 060	ZSE 001
1.3 135 X,LX,GLX	1.3	40	01.90–09.94	781.135E	4	ZM 060	
1.3 135 X,LX,GLX	1.3	40	07.93–09.94	781.135E	4		ZSE 001
1.3 135L	1.3	43	05.89–09.94	781.135	4	ZM 060	
1.3 135L	1.3	43	07.93–09.94	781.135	4		ZSE 001
1.3 136	1.3	45	10.90–09.94	136 L	4	ZM 060	

**FELICIA I**

1.3	1.3	40	10.94–03.98	135B/AMG	4	ZM 060	ZSE 001
1.3	1.3	43	10.94–03.98	AMJ/135 L	4	ZM 060	ZSE 001
1.3	1.3	50	10.94–03.98	136B/AMH	4	ZM 060	ZSE 001
1.6 LX	1.6	55	08.95–03.98	EA111/AEE	4		ZSE 001

**FELICIA I Fun**

1.3	1.3	40	06.97–04.02	135B/135M	4	ZM 060	ZSE 001
1.3	1.3	43	10.95–04.02	AMJ	4	ZM 060	ZSE 001
1.3	1.3	50	06.97–04.02	136B/136M	4	ZM 060	ZSE 001
1.6	1.6	55	06.97–04.02	AEE	4		ZSE 001

**FELICIA I Kombi**

1.3	1.3	43	08.95–03.98	AMJ/135 L	4	ZM 060	ZSE 001
1.3 LX	1.3	40	08.95–03.98	135B/AMG	4	ZM 060	ZSE 001
1.3 LXI	1.3	50	08.95–03.98	136B/AMH	4	ZM 060	ZSE 001
1.6 GLX	1.6	55	08.95–03.98	AEE	4		ZSE 001

**FELICIA II**

1.3	1.3	40	01.98–06.01	AMG	4	ZM 060	ZSE 001
1.3	1.3	40	01.98–06.01	AMG	4	ZM 060	ZSE 039
1.3	1.3	43	01.98–06.01	AMJ	4	ZM 060	ZSE 001
1.3	1.3	43	01.98–06.01	AMJ	4	ZM 060	ZSE 039
1.3	1.3	50	01.98–06.01	AMH	4	ZM 060	ZSE 001
1.3	1.3	50	01.98–06.01	AMH	4	ZM 060	ZSE 039
1.6	1.6	55	01.98–06.01	AEE	4		ZSE 001
1.6	1.6	55	01.98–06.01	AEE	4		ZSE 039

**FELICIA II Kombi**

1.3	1.3	50	01.98–06.01	AMH	4	ZM 060	ZSE 001
1.3	1.3	50	01.98–06.01	AMH	4	ZM 060	ZSE 039
1.6	1.6	55	01.98–06.01	AEE	4		ZSE 001





kW



## SKODA

## FELICIA II Kombi

1.6	1.6	55	01.98–06.01	AEE	4		ZSE 039	
-----	-----	----	-------------	-----	---	--	---------	--

## OCTAVIA (1U2)

1.4	1.4	44	04.99–03.01	AMD	4		ZSE 040	
1.4 16V	1.4	55	09.00–12.10	AXP/BCA	4		ZSE 003 <sup>202</sup>	
1.4 16V	1.4	55	09.00–12.10	AXP/BCA	4		ZSE 030 <sup>202</sup>	
1.4 16V	1.4	55	09.00–12.10	AXP/BCA	4		ZSE 040 <sup>202</sup>	
1.6	1.6	55	09.96–09.04	AEE	4		ZSE 001	
1.6	1.6	74	02.97–12.07	AKL/AEH	4		ZSE 003	
1.6	1.6	75	11.00–12.10	AVU/BFQ	4		ZSE 003	
1.8	1.8	92	09.96–07.00	AGN	4		ZSE 003	
1.8 T	1.8	110	08.97–12.10	AGU	4	ZM 062	ZS 016	ZLE 276
1.8 T 4x4	1.8	110	05.01–05.06	ARX	4		ZSE 043	
2.0	2.0	85	04.99–05.07	APK/AZH/AZJ/AQY/AEG	4		ZSE 003	
RS 1.8 T	1.8	132	05.01–01.06	AUQ	4		ZSE 043	

## OCTAVIA (1Z3)

1.2 TSI	1.2	77	02.10–	CBZB	4		ZSE 003	
1.4	1.4	55	05.04–05.06	BCA	4		ZSE 030 <sup>202</sup>	
1.4	1.4	55	05.04–05.06	BCA	4		ZSE 040 <sup>202</sup>	
1.4	1.4	59	06.04–12.11	BUD/CGGA	4		ZSE 030 <sup>202</sup>	
1.4 TSI	1.4	90	11.08–	CAXA	4		ZSE 030	
1.6	1.6	75	06.04–	BSE, BSF, BGU, CCSA, CMXA	4		ZSE 003	
1.6 FSI	1.6	85	02.04–10.08	BLF	4		ZSE 030	
1.6 MultiFuel	1.6	75	01.08–	CCSA	4		ZSE 003	
1.8 TSI	1.8	112	03.09–	CDAB	4		ZSE 142	
1.8 TSI	1.8	118	06.07–	BZB/CDA	4		ZSE 033 <sup>202</sup>	
1.8 TSI	1.8	118	06.07–	BZB/CDA	4		ZSE 140 <sup>202</sup>	
1.8 TSI	1.8	118	06.07–	BZB/CDA	4		ZSE 142 <sup>202</sup>	
2.0 FSI	2.0	110	11.04–	BLY/BLR/BVZ/BVY	4		ZSE 033 <sup>202</sup>	
2.0 FSI	2.0	110	11.04–	BLY/BLR/BVZ/BVY	4		ZSE 142 <sup>202</sup>	
2.0 RS	2.0	147	10.05–	BWA/CCZA	4		ZSE 033 <sup>202</sup>	
2.0 RS	2.0	147	10.05–	BWA/CCZA	4		ZSE 142 <sup>202</sup>	

## OCTAVIA (5E3)

1.2 TSI	1.2	63	11.12–	CJZB	4		ZSE 067 <sup>202</sup>	
1.2 TSI	1.2	63	11.12–	CJZB	4		ZSE 126 <sup>202</sup>	
1.2 TSI	1.2	77	11.12–	CJZA	4		ZSE 067 <sup>202</sup>	
1.2 TSI	1.2	77	11.12–	CJZA	4		ZSE 126 <sup>202</sup>	

## OCTAVIA Combi (1U5)

1.4 16V	1.4	55	08.00–12.10	AXP/BCA	4		ZSE 003 <sup>202</sup>	
1.4 16V	1.4	55	08.00–12.10	AXP/BCA	4		ZSE 030 <sup>202</sup>	
1.4 16V	1.4	55	08.00–12.10	AXP/BCA	4		ZSE 040 <sup>202</sup>	
1.6	1.6	55	07.98–09.04	AEE	4		ZSE 001	
1.6	1.6	74	07.98–12.07	AKL/AEH	4		ZSE 003	
1.6	1.6	75	09.00–12.10	AVU/BFQ	4		ZSE 003	
1.8 20V	1.8	92	07.98–07.00	AGN	4		ZSE 003	
1.8 T	1.8	110	07.98–12.10	AGU	4	ZM 062	ZS 016	ZLE 276
1.8 T	1.8	110	06.00–12.10	AUM	4		ZSE 043	
2.0	2.0	85	04.99–05.07	AEG, APK, AQY, AZH	4		ZSE 003	
2.0	2.0	85	04.99–05.07	AZJ	4		ZSE 029	
2.0 4x4	2.0	85	08.00–09.04	AZH	4		ZSE 003	
2.0 4x4	2.0	85	08.00–09.04	AZJ	4		ZSE 029	
2.0 4x4	2.0	88	01.00–12.10	ATF	4		ZSE 003	
RS 1.8 T	1.8	132	08.02–01.06	AUQ	4		ZSE 043	

## OCTAVIA Combi (1Z5)

1.2 TSI	1.2	77	02.10–	CBZB	4		ZSE 003	
1.4	1.4	59	05.06–12.11	BUD/CGGA	4		ZSE 030 <sup>202</sup>	
1.4 TSI	1.4	90	11.08–	CAXA	4		ZSE 030	
1.6	1.6	75	09.04–	BSE, BSF, BGU, CCSA, CMXA	4		ZSE 003	
1.6 FSI	1.6	85	02.04–10.08	BLF	4		ZSE 030	
1.6 LPG	1.6	75	08.09–	CHGA	4		ZSE 003	
1.6 MultiFuel	1.6	75	01.08–	CCSA	4		ZSE 003	
1.8 TSI	1.8	112	03.09–	CDAB	4		ZSE 142	



kW

**SKODA****OCTAVIA Combi (1Z5)**

1.8 TSI	1.8	118	06.07–	BZB/CDAA	4	<b>ZSE 033</b> <sup>202</sup>
1.8 TSI	1.8	118	06.07–	BZB/CDAA	4	<b>ZSE 142</b> <sup>202</sup>
1.8 TSI 4x4	1.8	112	03.09–	CDAB	4	<b>ZSE 033</b> <sup>202</sup>
1.8 TSI 4x4	1.8	112	03.09–	CDAB	4	<b>ZSE 142</b> <sup>202</sup>
1.8 TSI 4x4	1.8	118	11.08–	CDAA	4	<b>ZSE 033</b> <sup>202</sup>
1.8 TSI 4x4	1.8	118	11.08–	CDAA	4	<b>ZSE 142</b> <sup>202</sup>
2.0 FSI	2.0	110	11.04–	BLY/BLR/BVZ/BVY	4	<b>ZSE 033</b> <sup>202</sup>
2.0 FSI	2.0	110	11.04–	BLY/BLR/BVZ/BVY	4	<b>ZSE 142</b> <sup>202</sup>
2.0 FSI 4x4	2.0	110	11.04–	BVX/BLX	4	<b>ZSE 033</b> <sup>202</sup>
2.0 FSI 4x4	2.0	110	11.04–	BVX/BLX	4	<b>ZSE 142</b> <sup>202</sup>
2.0 RS	2.0	147	10.05–	BWA/CCZA	4	<b>ZSE 033</b> <sup>202</sup>
2.0 RS	2.0	147	10.05–	BWA/CCZA	4	<b>ZSE 142</b> <sup>202</sup>

**OCTAVIA Combi (5E5)**

1.2 TSI	1,2	63	11.12–	CJZB	4	<b>ZSE 067</b> <sup>202</sup>
1.2 TSI	1,2	63	11.12–	CJZB	4	<b>ZSE 126</b> <sup>202</sup>
1.2 TSI	1,2	77	11.12–	CJZA	4	<b>ZSE 067</b> <sup>202</sup>
1.2 TSI	1,2	77	11.12–	CJZA	4	<b>ZSE 126</b> <sup>202</sup>

**RAPID**

1.3	1.3	45	03.85–08.88	742,13	4	<b>ZS 106</b>
-----	-----	----	-------------	--------	---	---------------

**ROOMSTER**

1.2	1.2	47	05.06–01.07	BME	3	<b>ZSE 030</b>
1.2	1.2	51	01.07–	BZG/CGPA	3	<b>ZSE 030</b>
1.2 TSI	1.2	63	03.10–	CBZA	4	<b>ZSE 003</b>
1.2 TSI	1.2	77	03.10–	CBZB	4	<b>ZSE 003</b>
1.4	1.4	63	09.06–12.11	BXW , CGGB	4	<b>ZSE 030</b>
1.6	1.6	77	09.06–12.11	BTS , CFNA	4	<b>ZSE 030</b>

**ROOMSTER Praktik**

1.2	1.2	51	03.07–	BZG/CGPA Fgst.Nr.→5J-83147 326 , 5J-8A500 601 , 5J-8B502 695	3	<b>ZSE 030</b>
-----	-----	----	--------	--	---	----------------

1.2 TSI	1.2	63	03.10–	CBZA	4	<b>ZSE 003</b>
1.4	1.4	63	03.07–12.11	BXW , CGGB	4	<b>ZSE 030</b>

**SUPERB (3U4)**

1.8 T	1.8	110	12.01–01.04	AWT Fgst.Nr.3U-3-043320→ Fgst.Nr.→3U-4-064705	4	<b>ZSE 043</b>
2.0	2.0	85	12.01–03.08	AZM	4	<b>ZSE 003</b>

**SUPERB (3T4)**

1.4 TSI	1.4	92	07.08–	CAXC	4	<b>ZSE 030</b>
1.8 TSI	1.8	112	03.09–	CDAB	4	<b>ZSE 033</b> <sup>202</sup>
1.8 TSI	1.8	112	03.09–	CDAB	4	<b>ZSE 142</b> <sup>202</sup>
1.8 TSI	1.8	118	08.12–	BZB/CDAA	4	<b>ZSE 033</b>
1.8 TSI	1.8	118	03.08–	BZB/CDAA	4	<b>ZSE 142</b>
1.8 TSI 4x4	1.8	112	03.09–	CDAB	4	<b>ZSE 033</b> <sup>202</sup>
1.8 TSI 4x4	1.8	112	03.09–	CDAB	4	<b>ZSE 142</b> <sup>202</sup>
1.8 TSI 4x4	1.8	118	08.12–	CDAA	4	<b>ZSE 033</b>
1.8 TSI 4x4	1.8	118	11.08–	CDAA	4	<b>ZSE 142</b>
2.0 TSI	2.0	147	05.10–	CCZA	4	<b>ZSE 142</b>
3.6 V6 4x4	3.6	191	11.08–	CDVA	6	<b>ZSE 041</b>
3.6 V6 4x4	3.6	191	11.08–	CDVA	6	<b>ZSE 044</b>

**SUPERB Kombi (3T5)**

1.4 TSI	1.4	92	10.09–	CAXC	4	<b>ZSE 030</b>
1.8 TSI	1.8	112	10.09–	CDAB	4	<b>ZSE 033</b> <sup>202</sup>
1.8 TSI	1.8	112	10.09–	CDAB	4	<b>ZSE 142</b> <sup>202</sup>
1.8 TSI	1.8	118	08.12–	CDAA	4	<b>ZSE 033</b>
1.8 TSI	1.8	118	10.09–	CDAA	4	<b>ZSE 142</b>
1.8 TSI 4x4	1.8	112	10.09–	CDAB	4	<b>ZSE 033</b> <sup>202</sup>
1.8 TSI 4x4	1.8	112	10.09–	CDAB	4	<b>ZSE 142</b> <sup>202</sup>
1.8 TSI 4x4	1.8	118	08.12–	CDAA	4	<b>ZSE 033</b>
1.8 TSI 4x4	1.8	118	10.09–	CDAA	4	<b>ZSE 142</b>
2.0 TSI	2.0	147	05.10–	CCZA	4	<b>ZSE 142</b> <sup>202</sup>
3.6 V6 4x4	3.6	191	10.09–	CDVA	6	<b>ZSE 041</b>



kW

**SKODA**

YETI							
1.2 TSI	1.2	77	09.09–	CBZB	4		<b>ZSE 003</b>
1.4 TSI	1.4	90	06.10–	CAXA	4		<b>ZSE 030</b>
1.8 TSI 4x4	1.8	112	11.09–	CDAB	4		<b>ZSE 033<sup>202</sup></b>
1.8 TSI 4x4	1.8	112	11.09–	CDAB	4		<b>ZSE 142<sup>202</sup></b>
1.8 TSI 4x4	1.8	118	05.09–	CDA A	4		<b>ZSE 033<sup>202</sup></b>
1.8 TSI 4x4	1.8	118	05.09–	CDA A	4		<b>ZSE 142<sup>202</sup></b>

**SMART**

CABRIO (450)							
0.6	0.6	40	03.00–01.04	M 160 E6AL B03/M 160.920	3		<b>ZS 304</b>
0.6	0.6	45	01.01–12.02	M 160 E6AL B05/M 160.920	3		<b>ZS 304</b>
0.6	0.6	52	06.02–01.04	M 160.920	3		<b>ZS 304</b>
0.7	0.7	45	01.03–01.04	M 160.910	3		<b>ZS 304</b>
0.7	0.7	55	01.03–01.04	M 160.910	3		<b>ZS 304</b>
<b>CITY-COUPE (450)</b>							
0.6	0.6	33	07.98–01.04	M 160 E6AL B04/M 160.920	3		<b>ZS 304</b>
0.6	0.6	40	07.98–01.04	M 160 E6AL B03/M 160.920	3		<b>ZS 304</b>
0.6	0.6	45	01.01–12.02	M 160 E6AL B05/M 160.920	3		<b>ZS 304</b>
0.6	0.6	52	06.02–01.04	M 160.920	3		<b>ZS 304</b>
0.7	0.7	37	01.03–01.04	M 160.910	3		<b>ZS 304</b>
0.7	0.7	45	01.03–01.04	M 160.910	3		<b>ZS 304</b>
0.7	0.7	55	01.03–01.04	M 160.910	3		<b>ZS 304</b>
<b>CROSSBLADE (450)</b>							
0.6	0.6	52	06.02–12.03	M 160.920	3		<b>ZS 304</b>
<b>FORTWO Cabrio (450)</b>							
0.7	0.7	45	01.04–01.07	M 160.910	3		<b>ZS 304</b>
0.7	0.7	55	01.04–01.07	M 160.910	3		<b>ZS 304</b>
<b>FORTWO Coupe (450)</b>							
0.7	0.7	37	01.04–01.07	M 160.910	3		<b>ZS 304</b>
0.7	0.7	45	01.04–01.07	M 160.910	3		<b>ZS 304</b>
0.7	0.7	55	01.04–01.07	M 160.910	3		<b>ZS 304</b>
<b>ROADSTER (452)</b>							
0.7	0.7	45	04.03–11.05		3		<b>ZS 304</b>
0.7	0.7	60	04.03–11.05		3		<b>ZS 304</b>
0.7 Brabus	0.7	74	12.03–11.05	M 160.923	3		<b>ZS 304</b>
<b>ROADSTER Coupe (452)</b>							
0.7	0.7	45	06.03–11.05		3		<b>ZS 304</b>
0.7	0.7	60	04.03–11.05		3		<b>ZS 304</b>
0.7 Brabus	0.7	74	12.03–11.05	M 160.923	3		<b>ZS 304</b>

**SSANGYONG**

KORANDO							
2.0	2.0	94	05.97–10.01		4		<b>ZS 340 ZLE 234</b>
2.0	2.0	110	08.12–		4		<b>ZS 537</b>
2.3	2.3	103	05.97–10.01	M 111.970	4		<b>ZS 340 ZLE 234</b>
2.3	2.3	105	01.99–10.01		4		<b>ZS 340 ZLE 234</b>
3.2	3.2	156	01.99–	M 104.995	6		<b>ZS 340 ZLE 234</b>
<b>KYRON</b>							
3.2 M320 4WD	3.2	162	03.08–	G32D	6		<b>ZS 340 ZLE 234</b>
<b>MUSSO</b>							
2.0	2.0	93	10.96–	E20	4		<b>ZS 340 ZLE 234</b>
2.3	2.3	103	10.96–	M 111.970	4		<b>ZS 340 ZLE 234</b>
2.3	2.3	110	04.03–		4		<b>ZS 340 ZLE 234</b>
3.2	3.2	162	06.96–	M 104.992	6		<b>ZS 340 ZLE 234</b>
<b>REXTON</b>							
2.3 RX230 4x4	2.3	110	05.02–	G23D	4		<b>ZS 340 ZLE 234</b>
3.2	3.2	162	04.02–	G32D	6		<b>ZS 340 ZLE 234</b>
<b>RODIUS</b>							
3.2	3.2	162	07.07–	G32D	6		<b>ZS 340 ZLE 234</b>
3.2 4WD	3.2	162	07.07–	G32D	6		<b>ZS 340 ZLE 234</b>



kW

**SUBARU****LEONE II**

1800 4WD KAT

1.8

70

07.86–12.90

EA82

4

**ZM 046****SUZUKI****BALENO**

1.8 GTX

1.8

89

03.96–05.02

J18A

4

**ZSE 072****GRAND VITARA I**

1.6

1.6

69

03.98–07.03

G16B

4

**ZSE 136**

2.0

2.0

94

03.98–07.03

J20A

4

**ZSE 072**

2.5 V6 24V

2.5

106

04.98–07.03

H 25 A

6

**ZSE 072**

2.5 V6 24V

2.5

116

04.01–07.03

H 25 A

6

**ZSE 072**

2.7 XL-7

2.7

127

09.01–07.03

6

**ZSE 072**

2.7 XL-7

2.7

135

04.03–07.03

H 27 A

6

**ZSE 072****GRAND VITARA II**

1.6 Allrad

1.6

78

04.05–

M16A

4

**ZSE 069**

2.0 Allrad

2.0

103

10.05–

J20A

4

**ZSE 072****IGNIS (FH)**

1.3 4WD

1.3

61

10.00–09.03

M13A

4

**ZSE 069****IGNIS II**

1.3 4x4

1.3

69

09.03–

M13A

4

**ZSE 069**

1.5

1.5

73

09.03–

M15A

4

**ZSE 069**

1.5 4x4

1.5

73

09.03–

M15A

4

**ZSE 069**

1.5 Sport

1.5

80

12.03–

M15A

4

**ZSE 069****JIMNY**

1.3 16V

1.3

59

09.98–

G13BB

4

**ZSE 136**

1.3 16V

1.3

60

02.01–

M13A

4

**ZSE 136**

1.3 16V 4WD

1.3

59

09.98–

G13BB

4

**ZSE 136**

1.3 16V 4WD

1.3

60

02.01–

M13A

4

**ZSE 136**

1.3 16V 4x4

1.3

63

08.05–

M13A

4

**ZSE 136****LIANA**

1.3

1.3

66

03.02–

M13A

4

**ZSE 069**

1.6

1.6

76

03.02–

M16A

4

**ZSE 069**

1.6 4WD

1.6

78

04.02–

M16A

4

**ZSE 069**

1.6 4WD

1.6

79

01.05–

M16A

4

**ZSE 069**

1.6 i

1.6

78

04.02–

M16A

4

**ZSE 069****LIANA Kombi**

1.6

1.6

76

07.01–12.07

M16A

4

**ZSE 069**

1.6

1.6

79

01.05–12.07

M16A

4

**ZSE 069**

1.6 4WD

1.6

78

04.02–12.07

M16A

4

**ZSE 069**

1.6 4WD

1.6

79

01.05–12.07

M16A

4

**ZSE 069**

1.6 i

1.6

78

04.02–12.07

M16A

4

**ZSE 069****SJ 410**

1.0

1.0

33

09.81–12.88

F10A

4

**ZS 110****SWIFT I**

1.3 GTi/GXi

1.3

74

08.85–03.89

G13B

4

**ZM 024****ZS 274****SWIFT II**

1.3 GTi

1.3

74

03.89–05.01

G13B

4

**ZM 024****ZS 274****SWIFT III**

1.3

1.3

68

02.05–

M13A

4

**ZSE 069**

1.3 4x4

1.3

66

01.06–

M13A

4

**ZSE 069**

1.5

1.5

75

02.05–

M15A

4

**ZSE 069**

1.6

1.6

92

05.06–

M16A

4

**ZSE 069****SX4**

1.5

1.5

73

06.06–

M15A

4

**ZSE 069**

1.5 VWT

1.5

82

07.10–

M15A

4

**ZSE 069**

1.6 VWT

1.6

79

06.06–

M16A

4

**ZSE 069**

1.6 VWT

1.6

88

07.09–

M16A

4

**ZSE 069**

1.6 VWT 4x4

1.6

79

06.06–

M16A

4

**ZSE 069**

1.6 VWT 4x4

1.6

82

07.09–

M16A

4

**ZSE 069****VITARA**

2.0 16V

2.0

97

12.96–03.98

J20A

4

**ZSE 072**

2.0 V6 24V

2.0

100

12.94–03.98

H 20 A

6

**ZSE 072**



kW

**SUZUKI**

<b>SUZUKI</b>							
<b>VITARA</b>							
2.5 V6 24V	2.5	118	12.95–03.98	H 25 A	6		<b>ZSE 072</b>
<b>WAGON R+</b>							
1.3	1.3	69	09.03–	M13A	4		<b>ZSE 069</b>

**TALBOT**

<b>TALBOT</b>							
<b>SAMBA</b>							
1.1	1.1	37	01.81–06.86	XW7	4		<b>ZM 001</b>
1.4	1.4	53	01.81–06.86	XY8/XY7	4		<b>ZM 001</b>

**TOYOTA**

<b>TOYOTA</b>							
<b>ALPHARD I</b>							
3.0	3.0	162	04.03–04.08	1MZ-FE	6		<b>ZS 430</b>
3.0 4x4	3.0	162	04.03–04.08	1MZ-FE	6		<b>ZS 430</b>
<b>AVALON</b>							
3.0	3.0	137	08.01–04.05	1MZ-FE	6		<b>ZS 430</b>
3.0	3.0	140	03.95–05.05	1MZ-FE	6		<b>ZS 430</b>
<b>AVENSIS</b>							
1.6	1.6	74	09.97–10.00	4A-FE	4		<b>ZS 356</b>
1.6	1.6	81	09.97–10.00	4A-FE	4		<b>ZS 356</b>
<b>CAMRY ( V2 )</b>							
1.8 i	1.8	66	10.86–08.88	1S-L	4	<b>ZM 059</b>	<b>ZS 356</b>
2.0	2.0	94	11.86–05.91	3S-FE	4		<b>ZS 356</b>
2.0 4x4	2.0	94	08.88–05.91	3S-FE	4		<b>ZS 356</b>
2.0 Gli 16V	2.0	89	11.86–05.91	3S-FE	4		<b>ZS 356</b>
2.0 GLi 4x4	2.0	88	10.87–07.88	3S-FE	4		<b>ZS 356</b>
<b>CAMRY ( CV1 , XV1 , V1 )</b>							
3.0	3.0	135	09.93–07.96	1MZ-FE	6		<b>ZS 430</b>
<b>CAMRY ( CV2 , XV2 )</b>							
3.0 24V	3.0	140	08.96–11.01	1MZ-FE	6		<b>ZS 430</b>
3.0 V6	3.0	135	08.96–11.01	1MZ-FE	6		<b>ZS 430</b>
<b>CAMRY ( MCV3 , ACV3 , XV3 )</b>							
3.0	3.0	141	09.02–06.06	1MZ-FE	6		<b>ZS 430</b>
3.0 V6	3.0	137	11.01–11.06	1MZ-FE	6		<b>ZS 430</b>
<b>CARINA II</b>							
1.6	1.6	55	10.83–04.87	4A-LC	4	<b>ZM 058</b>	
1.6	1.6	62	10.83–11.87	4A-L	4	<b>ZM 058</b>	
1.6	1.6	63	10.86–04.87	4A-L	4	<b>ZM 058</b>	
1.6	1.6	66	12.87–11.89	4A-F	4		<b>ZS 356</b>
1.6	1.6	72	12.87–03.92	4A-FE	4		<b>ZS 356</b>
1.6	1.6	75	11.89–03.92	4A-FE	4	<b>ZM 057</b>	<b>ZS 356</b>
<b>CARINA II Station Wagon</b>							
1.6	1.6	66	12.87–12.89	4A-F	4		<b>ZS 356</b>
1.6	1.6	72	12.87–03.92	4A-FE	4	<b>ZM 057</b>	
1.6	1.6	75	12.87–03.92	4A-FE	4	<b>ZM 057</b>	
2.0	2.0	89	12.87–04.92	3S-FE	4		<b>ZS 356</b>
<b>CELICA</b>							
1.6	1.6	63	04.86–08.89	4A-L	4		<b>ZS 356</b>
1.6 GT 16V	1.6	91	04.86–08.89	4A-GEL	4	<b>ZM 057</b>	
1.8 i 16V	1.8	85	11.93–11.99	7A-FE	4		<b>ZS 356</b>
<b>COROLLA ( E8 )</b>							
1.3	1.3	51	06.83–10.84	2A-L	4	<b>ZM 058</b>	
1.3	1.3	55	10.84–08.87	2E-LC/2E-L	4		<b>ZS 356</b>
1.6	1.6	53	08.85–08.87	4A-LC	4	<b>ZM 058</b>	<b>ZS 356</b>
1.6	1.6	53	08.85–08.87	4A-LC KAT	4	<b>ZM 059</b>	<b>ZS 356</b>
1.6	1.6	54	12.85–05.88	4A-LC KAT	4	<b>ZM 059</b>	<b>ZS 356</b>
1.6	1.6	54	12.85–12.87	4A-LC	4	<b>ZM 058</b>	<b>ZS 356</b>
1.6	1.6	62	06.83–08.87	4A-L	4	<b>ZM 058</b>	
1.6	1.6	62	01.84–08.87	4A-L KAT	4	<b>ZM 059</b>	<b>ZS 356</b>



kW

**TOYOTA****COROLLA ( E9 )**

1.3 i	1.3	55	08.87-04.92	2E-E/2E	4		<b>ZS 356</b> <sup>202</sup>
1.3 i	1.3	55	08.87-08.89	2E-E/2E	4	<b>ZM 057</b> <sup>202</sup>	
1.3 i	1.3	55	09.89-12.90	2E-E/2E	4	<b>ZM 059</b> <sup>202</sup>	
1.3 i	1.3	55	09.89-12.92	2E-E/2E	4	<b>ZM 058</b> <sup>202</sup>	
1.6	1.6	66	08.87-12.89	4A-F	4	<b>ZM 059</b>	<b>ZS 356</b>
1.6 i	1.6	77	11.89-12.90	4A-FE KAT	4	<b>ZM 059</b>	

**COROLLA ( E10 )**

1.3 12V	1.3	53	07.92-04.97	2E	4		<b>ZS 356</b>
1.3 XLI	1.3	55	09.95-04.97	4E-FE	4		<b>ZS 356</b>
1.3 XLI 16V	1.3	65	07.92-09.95	4E-FE	4		<b>ZS 356</b>
1.6 Si	1.6	84	09.95-04.97	4A-FE	4		<b>ZS 356</b>

**COROLLA ( E11 )**

1.4 16V	1.4	71	02.00-11.01	4ZZ-FE	4		<b>ZS 449</b>
1.6	1.6	81	04.97-02.00	4A-FE	4		<b>ZS 356</b>

**CORONA**

1.5	1.5	85	11.87-08.89		4		<b>ZS 356</b>
-----	-----	----	-------------	--	---	--	---------------

**HARRIER**

3.0 VTI 4x4	3.0	150	10.03-12.08	1MZ-FE	6		<b>ZS 430</b>
3.0 4x4	3.0	164	03.98-01.03	1MZ-FE	6		<b>ZS 430</b>

**PASEO**

1.5 16V	1.5	66	10.96-03.99	5E-FE	4		<b>ZS 356</b>
---------	-----	----	-------------	-------	---	--	---------------

**PREVIA**

3.0 VTI	3.0	162	08.00-12.05	1MZ-FE	6		<b>ZS 430</b>
---------	-----	-----	-------------	--------	---	--	---------------

**RAV 4 I**

2.0 16V 4WD	2.0	95	06.94-06.00	3S-FE	4		<b>ZS 356</b>
-------------	-----	----	-------------	-------	---	--	---------------

**SIENNA**

3.0	3.0	143	05.97-04.03	1MZ-FE	6		<b>ZS 430</b>
3.0	3.0	154	05.97-04.03	1MZ-FE	6		<b>ZS 430</b>

**STARLET ( P7 )**

1.3	1.3	55	01.85-12.89	2E-LC	4	<b>ZM 057</b>	<b>ZS 356</b>
-----	-----	----	-------------	-------	---	---------------	---------------

**STARLET ( P8 )**

1.3 12V	1.3	55	06.91-12.92	2E-E/2E	4	<b>ZM 057</b>	<b>ZS 356</b>
1.3 12V	1.3	55	12.89-03.96	2E-E	4	<b>ZM 057</b>	<b>ZS 356</b>

**STARLET (EP91)**

1.3	1.3	55	04.96-03.99	4E-FE	4	<b>ZM 057</b>	<b>ZS 356</b>
-----	-----	----	-------------	-------	---	---------------	---------------

**TERCEL**

1.5 4WD	1.5	50	05.86-01.88	3A-C	4	<b>ZM 058</b>	<b>ZS 110</b>
---------	-----	----	-------------	------	---	---------------	---------------

**VISTA**

3.0	3.0	140	03.98-08.02	1MZ-FE	6		<b>ZS 430</b>
-----	-----	-----	-------------	--------	---	--	---------------

**WINDOM**

3.0	3.0	155	10.96-07.01	1MZ-FE	6		<b>ZS 430</b>
3.0 VTI G	3.0	137	08.01-07.04	1MZ-FE	6		<b>ZS 430</b>

**DYNA 100**

1.8	1.8	58	08.85-04.95	2Y	4		<b>ZS 356</b>
-----	-----	----	-------------	----	---	--	---------------

**HIACE III**

2.0	2.0	74	02.90-08.95	1RZ	4		<b>ZS 356</b>
2.4	2.4	88	08.89-08.95	2RZ-E	4		<b>ZS 356</b>

**HIACE IV**

2.4	2.4	85	08.95-04.98	2RZ-E	4		<b>ZS 356</b>
-----	-----	----	-------------	-------	---	--	---------------

**HILUX II**

1.8	1.8	61	08.88-07.94	2Y	4		<b>ZS 356</b>
-----	-----	----	-------------	----	---	--	---------------

**KLUGER**

3.0 4x4	3.0	150	10.03-05.07	1MZ-FE	6		<b>ZS 430</b>
3.0 4x4	3.0	164	06.00-09.03	1MZ-FE	6		<b>ZS 430</b>

**MODELL F**

1.8 De Luxe	1.8	58	11.82-08.84	2Y-C/2Y	4		<b>ZS 356</b>
2.0 Super	2.0	65	08.84-08.88	3Y/3Y-C	4		<b>ZS 356</b>



kW



**TRABANT**

<b>P 601</b>							
0.6	0.6	19	03.70–04.90	P63/64	2		<b>ZS 106</b>
<b>P 601 Tramp</b>							
0.6	0.6	19	10.66–12.85	P65/66/P63/64	2		<b>ZS 106</b>

**TRIUMPH**

<b>ACCLAIM</b>							
1.3	1.3	51	01.82–12.84	EJ	4		<b>ZM 054</b>

**TVR**

<b>350</b>							
3.5 i	3.5	145	01.85–12.89		8		<b>ZM 047</b>
<b>390</b>							
3.9	3.9	205	01.85–12.89		8		<b>ZM 047</b>
<b>420</b>							
4.2	4.2	224	01.85–12.89		8		<b>ZM 047</b>

**UAZ**

<b>HUNTER</b>							
2.7	2.7	94	01.08–	ZMZ-409.10	4		<b>ZS 535</b>

**VAUXHALL**

<b>AGILA Mk I</b>							
1.0 12V	1.0	43	09.00–08.05	Z 10 XE	3		<b>ZS 358</b>
1.0 12V	1.0	44	02.00–11.06	Z 10 XEP	3		<b>ZS 359</b>
1.2 16V Twinport	1.2	59	07.04–11.06	Z 12 XEP	4		<b>ZS 338</b>
<b>ASTRA Mk II</b>							
1.6	1.6	66	01.86–12.87	16 SH	4		<b>ZM 007</b>
1.8	1.8	82	01.86–12.90	18 SE	4		<b>ZS 127</b>
1.8	1.8	82	01.86–12.90	18 SE	4		<b>ZS 253</b>
1.8 i	1.8	85	09.85–08.91	18 SE/18 E	4		<b>ZS 127</b>
1.8 i	1.8	85	09.85–08.91	18 SE/18 E	4		<b>ZS 253</b>
<b>ASTRA Mk III</b>							
1.4 i	1.4	44	09.91–02.98	C 14 NZ	4		<b>ZS 253</b>
1.4 i	1.4	60	04.92–09.98	C 14 SE	4		<b>ZS 253</b>
1.8 i	1.8	66	03.92–09.98	C 18 NZ	4		<b>ZM 018</b>
1.8 i 16V	1.8	85	01.94–12.96	C 18 XEL	4		<b>ZS 344</b>
1.8 i 16V	1.8	92	06.93–10.94	C 18 XE	4		<b>ZS 344</b>
2.0 i 16V	2.0	100	02.95–09.98	X 20 XEV	4		<b>ZS 344</b>
<b>ASTRA Mk IV</b>							
1.4 16V	1.4	66	02.98–05.05	X 14 XE/Z 14 XE	4		<b>ZS 259</b> <b>GS 39</b>
1.6 16V	1.6	74	02.98–05.05	Z 16 XE/X 16 XEL	4		<b>ZS 259</b> <b>GS 39</b>
1.8 16V	1.8	85	02.98–09.00	X 18 XE1	4		<b>ZS 342</b>
1.8 16V	1.8	92	09.00–05.05	Z 18 XE	4		<b>ZS 342</b>
2.0 16V	2.0	100	02.98–02.04	X 20 XEV	4		<b>ZS 344</b>
<b>ASTRA Mk V</b>							
1.2	1.2	59	08.05–05.09	Z 12 XEP	4		<b>ZS 338</b>
1.4	1.4	66	01.04–05.09	Z 14 XEP	4		<b>ZS 338</b>
1.6	1.6	77	12.05–05.09	Z 16 XEP	4		<b>ZS 427</b>
1.6	1.6	85	12.05–05.09	Z 16 XER	4		<b>ZS 427</b>
<b>CALIBRA</b>							
2.0 i	2.0	85	06.90–07.97	C 20 NE Mot.Nr.→14180385	4		<b>ZS 125</b>
2.0 i	2.0	85	06.90–07.97	C 20 NE Mot.Nr.14180386→	4		<b>ZS 127</b>
2.0 i 16V	2.0	100	06.90–07.97	X 20 XEV	4		<b>ZS 344</b>
2.0 i 16V	2.0	110	06.90–02.94	C 20 XE	4		<b>ZM 026</b> <b>ZS 300</b>
2.0 i 16V 4x4	2.0	110	06.90–02.94	C 20 XE	4		<b>ZM 026</b> <b>ZS 300</b>
2.0 i 4x4	2.0	85	06.90–07.97	C 20 NE Mot.Nr.→14180385	4		<b>ZS 125</b>
2.0 i 4x4	2.0	85	06.90–07.97	C 20 NE Mot.Nr.14180386 →	4		<b>ZS 127</b>



kW



## VAUXHALL

Model	Year	Power (kW)	Year Range	Engine	Cylinders	Part Number
<b>CALIBRA</b>						
2.5 i V6	2.5	125	04.93-07.97	X 25 XE/C 25 XE	6	<b>ZS 301</b>
<b>CARLTON Mk III</b>						
1.8 N	1.8	60	09.86-08.87	18 NV Mot.Nr.→14180385	4	<b>ZS 125</b>
1.8 N	1.8	60	09.86-08.87	18 NV Mot.Nr.14258180→	4	<b>ZS 127</b>
1.8 i	1.8	85	09.86-03.94	18 SEH	4	<b>ZM 032</b>
2.0	2.0	73	09.90-03.94	C 20 NEJ Mot.Nr.→14180385	4	<b>ZS 125</b>
2.0	2.0	73	09.90-03.94	C 20 NEJ Mot.Nr.14258180→	4	<b>ZS 127</b>
2.0	2.0	74	09.90-03.94	C 20 NEF Mot.Nr.→14180385	4	<b>ZS 125</b>
2.0	2.0	74	09.90-03.94	C 20 NEF Mot.Nr.14258180→	4	<b>ZS 127</b>
2.0	2.0	85	09.86-03.94	C 20 NE Mot.Nr.→14180385	4	<b>ZS 125</b>
2.0	2.0	85	09.86-03.94	C 20 NE Mot.Nr.14180386→	4	<b>ZS 127</b>
2.0 i	2.0	90	09.86-03.94	20 SE Mot.Nr.→14180385	4	<b>ZS 125</b>
2.0 i	2.0	90	09.86-03.94	20 SE Mot.Nr.14258180→	4	<b>ZS 127</b>
2.4 i	2.4	92	09.88-03.94	C 24 NE Fgst.Nr.→K1999999	4	<b>ZS 127</b>
2.4 i	2.4	92	09.88-03.94	C 24 NE Fgst.Nr.L1000001→	4	<b>ZS 125</b>
3.0 3000	3.0	130	03.87-09.90	30 NE	6	<b>ZS 125</b>
3.0 3000	3.0	130	03.87-09.90	30 NE	6	<b>ZS 127</b>
3.6 24V Lotus	3.6	277	08.90-09.92	C 36 GET	6	<b>ZS 355</b>
3000	3.0	115	03.87-12.87	C 30 LE Fgst.Nr.K1000099→ Fgst.Nr.→K1999999	6	<b>ZS 125</b>
3000	3.0	115	03.87-12.87	C 30 LE Fgst.Nr.L1000001→	6	<b>ZS 127</b>
3000 KAT	3.0	130	03.88-03.94	C 30 NE Fgst.Nr.K100009→ Fgst.Nr.→K199999	6	<b>ZS 125</b>
3000 KAT	3.0	130	03.88-03.94	C 30 NE Fgst.Nr.L1000001→	6	<b>ZS 127</b>
<b>CAVALIER Mk II</b>						
1.3 S	1.3	55	09.81-08.88	13 S	4	<b>ZM 006</b>
1.6 S	1.6	66	09.81-08.88	16 SH	4	<b>ZM 002</b> <sup>283</sup>
<b>CAVALIER Mk III</b>						
2.0 i	2.0	85	09.88-10.90	20 NE Mot.Nr.→14180385	4	<b>ZS 125</b>
2.0 i	2.0	85	09.88-10.90	20 NE Mot.Nr.14180386→	4	<b>ZS 127</b>
2.0 i 16V	2.0	110	09.88-11.95	C 20 XE	4	<b>ZM 034 ZS 300</b>
2.0 i 16V 4x4	2.0	110	09.88-11.95	C 20 XE	4	<b>ZM 034 ZS 300</b>
2.0 i 4x4	2.0	85	01.91-10.92	20 NE Mot.Nr.→14180385	4	<b>ZS 125</b>
2.0 i 4x4	2.0	85	01.91-10.92	20 NE Mot.Nr.14180386→	4	<b>ZS 127</b>
2.0 i 4x4	2.0	95	09.88-09.92	20 SHE Mot.Nr.→14180385	4	<b>ZS 125</b>
2.0 i 4x4	2.0	95	09.88-09.92	20 SHE Mot.Nr.14180386→	4	<b>ZS 127</b>
2.0 i KAT	2.0	85	09.90-11.95	C 20 NE Mot.Nr.→14180385	4	<b>ZS 125</b>
2.0 i KAT	2.0	85	09.90-11.95	C 20 NE Mot.Nr.14180386→	4	<b>ZS 127</b>
2.0 i Turbo 4x4	2.0	150	06.92-11.94	C 20 LET	4	<b>ZS 127</b>
2.0 SRi	2.0	95	09.88-09.92	20 SEH Mot.Nr.→14180385	4	<b>ZS 125</b>



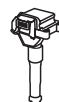

kW

**VAUXHALL****CAVALIER Mk III**

2.0 SRi	2.0	95	09.88–09.92	20 SEH Mot.Nr.14180386→	4		<b>ZS 127</b>	
2.0 SRi 16V	2.0	100	09.93–11.95	X 20 XEV	4		<b>ZS 344</b>	
2.5 V6	2.5	125	08.88–06.94	C 25 XE	6		<b>ZS 301</b>	

**COMBO Mk II**

1.4 16V	1.4	66	10.01–05.07	Z 14 XE	4		<b>ZS 259</b>	<b>GS 39</b>
1.4 i 16V	1.4	66	01.04–11.11	Z 14 XEP	4		<b>ZS 338</b>	
1.6 CNG 16V	1.6	69	06.06–02.12	Z 16 YNG	4		<b>ZS 259</b>	<b>GS 39</b>
1.6 CNG 16V	1.6	71	04.05–02.12	Z 16 YNG	4		<b>ZS 259</b>	<b>GS 39</b>

**CORSA Mk I**

1.0 i 12V	1.0	40	11.96–09.00	X 10 XE	3		<b>ZS 358</b>	
1.2 i	1.2	33	03.93–09.00	C 12 NZ/X 12 SZ	4		<b>ZS 253</b>	
1.4 i	1.4	44	03.93–09.00	C 14 NZ/X 14 SZ	4		<b>ZS 253</b>	

**CORSA Mk II**

1.0 12V	1.0	43	09.00–10.03	Z 10 XE	3		<b>ZS 358</b>	
1.0 12V	1.0	44	11.03–10.06	Z 10 XEP	3		<b>ZS 359</b>	
1.2 Twinport	1.2	59	07.04–10.06	Z 12 XEP	4		<b>ZS 338</b>	
1.4 16V	1.4	66	09.00–10.06	Z 14 XE	4		<b>ZS 259</b>	<b>GS 39</b>
1.6 CNG	1.6	69	05.03–10.06	Z 16 YNG	4		<b>ZS 259</b>	<b>GS 39</b>
1.8 16V	1.8	92	08.00–09.06	Z 18 XE	4		<b>ZS 342</b>	

**CORSA Mk III**

1.0	1.0	44	11.06–	Z 10 XEP	3		<b>ZS 359</b>	
1.2	1.2	59	11.06–	Z 12 XEP	4		<b>ZS 338</b>	
1.4	1.4	66	07.06–	Z 14 XEP	4		<b>ZS 338</b>	
1.6 SRi	1.6	110	05.07–	Z 16 LEL/A 16 LEL	4		<b>ZS 427</b>	
1.6 VXR	1.6	141	02.07–	A 16 LER/Z 16 LER	4		<b>ZS 427</b>	

**FRONTERA Mk I**

2.0 i	2.0	85	03.92–10.98	X20SE Fgst.Nr.SV 720103→	4		<b>ZS 300</b>	
2.2 i	2.2	100	03.95–10.98	X 22 XE Fgst.Nr.SV 720103→	4		<b>ZS 300</b>	

**MERIVA Mk I**

1.4 16V Twinport	1.4	66	01.03–10.09	Z 14 XEP	4		<b>ZS 338</b>	
1.6 i 16V	1.6	74	01.03–10.09	Z 16 XE	4		<b>ZS 259</b>	
1.6 i 16V Twinport	1.6	77	12.05–10.09	Z 16 XEP	4		<b>ZS 427</b>	
1.6 Turbo	1.6	132	05.06–06.10	Z 16 LET	4		<b>ZS 427</b>	

**MONTEREY**

3.2	3.2	130	06.92–07.98	6 VD1	6		<b>ZS 355</b>	
-----	-----	-----	-------------	-------	---	--	---------------	--

**NOVA CC**

1.4 i S	1.4	60	09.91–03.93	C 14 SE	4		<b>ZS 253</b>	
---------	-----	----	-------------	---------	---	--	---------------	--

**OMEGA (B)**

2.0	2.0	85	03.94–09.99	X 20 SE	4		<b>ZS 300</b>	
2.5 V6	2.5	125	03.94–09.00	X 25 XE	6		<b>ZS 301</b>	
2.5 V6	2.5	125	03.94–09.00	X 25 XE	6		<b>ZS 306</b>	
3.0 V6	3.0	155	04.94–07.00	X 30 XE	6		<b>ZS 301</b>	
3.0 V6	3.0	155	04.94–07.00	X 30 XE	6		<b>ZS 306</b>	

**SENATOR Mk II**

3.0	3.0	115	09.87–09.93	C 30 LE Fgst.Nr.K1000099→ Fgst.Nr.→K1999999	6		<b>ZS 125</b>	
3.0	3.0	115	09.87–09.93	C 30 LE Fgst.Nr.L1000001→	6		<b>ZS 127</b>	
3.0 i KAT	3.0	130	01.88–09.93	C 30 NE Fgst.Nr.K1000099→ Fgst.Nr.→K1999999	6		<b>ZS 125</b>	
3.0 i KAT	3.0	130	01.88–09.93	C 30 NE Fgst.Nr.L1000001→	6		<b>ZS 127</b>	

**SIGNUM**

1.8	1.8	90	06.03–07.05	Z 18 XE	4		<b>ZS 342</b>	
1.8	1.8	103	12.05–05.08	Z 18 XER	4		<b>ZS 427</b>	

**TIGRA TwinTop**

1.4	1.4	66	06.04–08.09	Z 14 XEP	4		<b>ZS 338</b>	
-----	-----	----	-------------	----------	---	--	---------------	--



kW

**VAUXHALL**
**VECTRA (B)**

1.6 i 16V	1.6	74	08.95–10.01	Z 16 XE/X 16 XEL/Y 16 XE	4		<b>ZS 259</b>	<b>GS 39</b>
1.8 i 16V	1.8	85	10.95–09.00	X 18 XE/X 18 XE1	4		<b>ZS 342</b>	
1.8 i 16V	1.8	85	10.95–09.00	X 18 XE	4		<b>ZS 344</b>	
1.8 i 16V	1.8	92	09.00–03.02	Z 18 XE	4		<b>ZS 342</b>	
2.0 i 16V	2.0	100	10.95–01.01	X 20 XEV	4		<b>ZS 344</b>	

**ZAFIRA Mk I**

1.6 16V	1.6	74	04.99–08.05	Z 16 XE/X 16 XEL	4		<b>ZS 259</b>	<b>GS 39</b>
1.6 CNG	1.6	71	09.01–06.05	Z 16 YNG	4		<b>ZS 259</b>	<b>GS 39</b>
1.8 16V	1.8	85	05.99–08.00	X 18 XE1	4		<b>ZS 342</b>	
1.8 16V	1.8	92	09.00–08.05	Z 18 XE	4		<b>ZS 342</b>	

**ZAFIRA Mk II**

1.6	1.6	77	12.05–	Z 16 XEP	4		<b>ZS 427</b>	
1.6 CNG	1.6	69	07.05–	Z 16 YNG	4		<b>ZS 259</b>	<b>GS 39</b>
1.8	1.8	103	12.05–	Z 18 XER/A 18 XER	4		<b>ZS 427</b>	

**ZAFIRA Mk III**

1.6 CNG	1.6	110	10.11–	A 16 XNT	4		<b>ZS 427</b>	
---------	-----	-----	--------	----------	---	--	---------------	--

**VIVARO**

2.0 16V	2.0	88	08.01–12.06	F4R 720	4		<b>ZS 052<sup>282</sup></b>	<b>GS 29</b>
2.0 ECOTEC	2.0	86	08.06–	F4R 820	4		<b>ZS 052<sup>282</sup></b>	<b>GS 29</b>

**VOLVO**
**240**

2.0	2.0	76	08.84–07.85	B 200 K	4		<b>ZM 039</b>	
2.1	2.1	79	08.80–07.84	B 21 A	4			<b>ZS 106</b>
2.3	2.3	81	08.84–07.86	B 230 A	4		<b>ZM 039</b>	
2.3	2.3	83	08.86–07.87	B 230 F	4		<b>ZM 040</b>	
2.3 i KAT	2.3	85	08.86–07.90	B 230 K	4		<b>ZM 039</b>	
2.3 i KAT	2.3	85	08.86–07.93	B 230 F Fgst.Nr.809000→	4			<b>ZS 120</b>

**240 Kombi**

2.3	2.3	81	08.84–07.86	B 230 A	4		<b>ZM 039</b>	
2.3	2.3	83	08.86–07.87	B 230 F	4		<b>ZM 040</b>	
2.3	2.3	96	08.84–07.85	B 230 E	4		<b>ZM 002</b>	
2.3 i KAT	2.3	85	08.86–07.93	B 230 F Fgst.Nr.809000→	4		<b>ZM 015</b>	<b>ZS 120</b>
2.3 i KAT	2.3	85	08.86–12.90	B 230 F	4		<b>ZM 040</b>	

**340-360**

1.4	1.4	46	08.82–08.85	B 14.3 E	4			<b>ZS 115<sup>285</sup></b>
1.4	1.4	46	08.82–08.85	B 14.3 E	4			<b>ZS 251<sup>284</sup></b>
1.4	1.4	50	08.86–12.88	B 14.4 S	4			<b>ZS 115<sup>285</sup></b>
1.4	1.4	50	08.86–12.88	B 14.4 S	4			<b>ZS 251<sup>284</sup></b>
1.4	1.4	51	08.87–07.88	B 14.4 S	4			<b>ZS 115<sup>285</sup></b>
1.4	1.4	51	08.87–07.88	B 14.4 S	4			<b>ZS 251<sup>284</sup></b>
2.0	2.0	77	08.84–07.87	B 200 K	4		<b>ZM 039</b>	<b>ZS 251</b>
2.0	2.0	87	08.84–07.86	B 200 E	4			<b>ZS 251</b>

**440 K**

1.7	1.7	64	09.88–12.96	B 18 KP	4			<b>ZS 251</b>
1.7	1.7	70	08.88–07.89	B 18 F	4			<b>ZS 251</b>
1.7	1.7	75	08.89–12.96	B 18 FP	4			<b>ZS 251</b>
1.7	1.7	78	09.88–12.96	B 18 EP	4			<b>ZS 251</b>
1.7 Turbo	1.7	88	08.88–07.96	B 18 FT	4		<b>ZM 033</b>	
1.7 Turbo	1.7	90	01.91–12.96	B 18 FT	4		<b>ZM 033</b>	
1.8	1.8	66	08.91–07.96	B 18 U	4			<b>ZS 251</b>
2.0	2.0	80	08.93–07.96	B 20 F	4			<b>ZS 251</b>

**460 L**

1.6	1.6	61	07.92–07.96	B 16 F	4			<b>ZS 251</b>
1.7	1.7	75	08.89–07.92	B 18 EP	4			<b>ZS 251<sup>284</sup></b>
1.7 Turbo	1.7	88	08.89–12.93	B 18 FT	4		<b>ZM 033</b>	
1.7 Turbo	1.7	90	01.91–07.96	B 18 FT	4		<b>ZM 033</b>	
1.8	1.8	66	08.91–07.96	B 18 U	4			<b>ZS 251</b>
2.0	2.0	80	08.93–07.96	B 20 F	4			<b>ZS 251</b>



kW

**VOLVO****480 E**

1.7	1.7	70	08.87-07.89	B 18 F	4		<b>ZS 251</b>
1.7	1.7	75	08.89-07.96	B 18 EP	4		<b>ZS 251</b>
1.7	1.7	78	04.86-07.89	B 18 E	4		<b>ZS 251</b>
1.7	1.7	80	08.86-07.88	B 18 E	4		<b>ZS 251</b>
1.7 Turbo	1.7	88	01.88-12.93	B 18 FT	4	<b>ZM 033</b>	
1.7 Turbo	1.7	90	01.91-12.93	B 18 FT	4	<b>ZM 033</b>	

**740**

2.0	2.0	86	01.87-08.88	B 200 E	4	<b>ZM 040</b>	
2.0	2.0	86	01.87-08.88	B 200 E	4		<b>ZS 119</b>
2.3	2.3	83	09.85-12.89	B 230 F	4	<b>ZM 039</b>	
2.3	2.3	84	08.84-07.90	B 23 A/B 230 F	4	<b>ZM 039</b>	<b>ZS 119</b>
2.3	2.3	85	08.87-07.92	B 230 F	4	<b>ZM 039</b>	<b>ZS 119</b>
2.3	2.3	86	08.86-07.88	B 230 K	4	<b>ZM 039</b>	<b>ZS 119</b>
2.3	2.3	95	08.83-07.84	B 23 E	4	<b>ZM 002</b>	<b>ZS 120</b>
2.3	2.3	96	01.87-07.88	B 230 E	4	<b>ZM 040</b>	
2.3	2.3	96	08.84-07.88	B 230 E	4		<b>ZS 119</b>
2.3	2.3	111	08.88-07.90	B 234 F	4		<b>ZS 119</b>
2.3	2.3	111	08.88-12.90	B 234 F	4	<b>ZM 040</b>	<b>ZS 119</b>
2.3	2.3	114	08.88-12.90	B 234 F	4	<b>ZM 040</b>	
2.3	2.3	117	08.87-07.89	B 234 F	4	<b>ZM 040</b>	<b>ZS 119</b>
2.3 Turbo	2.3	115	08.86-07.89	B 230 FT	4		<b>ZS 119</b>
2.3 Turbo	2.3	121	08.89-07.90	B 230 FT	4	<b>ZM 040</b>	<b>ZS 119</b>
2.3 Turbo	2.3	140	08.89-07.90	B 230 FT	4	<b>ZM 040</b>	<b>ZS 119</b>

**740 Kombi**

2.0	2.0	82	08.89-07.91	B 200 F	4		<b>ZS 119</b>
2.0	2.0	86	01.87-08.88	B 200 E	4		<b>ZS 119</b>
2.3	2.3	83	08.85-12.89	B 230 F	4	<b>ZM 040</b>	<b>ZS 119</b>
2.3	2.3	84	09.85-07.90	B 230 K	4	<b>ZM 039</b>	<b>ZS 119</b>
2.3	2.3	85	08.87-07.92	B 230 F	4	<b>ZM 039</b>	<b>ZS 119</b>
2.3	2.3	87	01.88-10.90	B 230 F	4	<b>ZM 039</b>	<b>ZS 119</b>
2.3	2.3	96	01.87-07.88	B 230 E	4	<b>ZM 040</b>	
2.3	2.3	96	08.85-07.88	B 230 E	4		<b>ZS 119</b>
2.3	2.3	111	07.89-08.92	B 234 F	4		<b>ZS 119</b>
2.3	2.3	111	07.89-12.90	B 234 F	4	<b>ZM 040</b>	
2.3	2.3	114	08.88-07.90	B 234 F	4	<b>ZM 040</b>	<b>ZS 119</b>
2.3	2.3	117	08.87-07.89	B 234 F	4	<b>ZM 040</b>	<b>ZS 119</b>
2.3 GL	2.3	89	08.84-08.87	B 230 E	4		<b>ZS 119</b>
2.3 Turbo	2.3	115	08.86-07.89	B 230 FT	4	<b>ZM 040</b>	<b>ZS 119</b>
2.3 Turbo	2.3	121	08.89-07.90	B 230 GT/B 230 FT	4	<b>ZM 040</b>	<b>ZS 119</b>
2.3 Turbo	2.3	140	08.89-07.90	B 230 FT	4	<b>ZM 040</b>	<b>ZS 119</b>

**760**

2.3	2.3	119	01.88-07.92	B 230 FT	4		<b>ZS 119</b>
2.8	2.8	105	05.86-08.91	B 280 F	6	<b>ZM 040</b>	<b>ZS 119</b>
2.8	2.8	108	08.86-07.90	B 280 F	6	<b>ZM 040</b>	<b>ZS 119</b>
2.8	2.8	115	08.86-07.88	B 280 E/B 28 E	6	<b>ZM 040</b>	

**760 Kombi**

2.8	2.8	105	05.86-08.91	B 280 F	6	<b>ZM 040</b>	<b>ZS 119</b>
2.8	2.8	115	08.86-08.90	B 280 E/B 28 E	6	<b>ZM 040</b>	<b>ZS 119</b>

**780**

2.9	2.8	108	08.87-07.90	B 280 F	6	<b>ZM 040</b>	<b>ZS 119</b>
2.9	2.8	115	08.86-07.87	B 280 E	6	<b>ZM 040</b>	<b>ZS 119</b>

**850**

2.0	2.0	93	08.95-12.96	B 5202 S	5	<b>ZM 036</b>	
2.0	2.0	93	08.95-12.96	B 5202 S	5		<b>ZSE 037</b>
2.0	2.0	105	08.95-12.96	B 5204 F	5	<b>ZM 036</b>	
2.0	2.0	105	06.91-12.96	B 5204 F	5		<b>ZS 251</b>
2.0	2.0	105	08.95-12.96	B 5204 F	5		<b>ZSE 037</b>
2.0 Turbo	2.0	155	08.95-12.96	B 5204 T/B 5204 FT	5	<b>ZM 036</b>	<b>ZSE 037</b>
2.3 T5	2.3	166	08.95-07.96	B 5234 FT	5	<b>ZM 036</b>	<b>ZSE 037</b>
2.3 T5-R	2.3	184	08.95-12.96	B 5234 T4	5	<b>ZM 036</b>	<b>ZSE 037</b>
2.5	2.4	103	06.91-07.94	B 5252	5	<b>ZM 036</b>	<b>ZSE 037</b>



kW

**VOLVO**

<b>850</b>								
2.5	2.4	106	08.95–12.96	B 5252 S	5	ZM 036	ZSE 037	
2.5	2.4	125	08.95–12.96	B 5254 S	5	ZM 036	ZSE 037	
<b>850 Kombi</b>								
2.0	2.0	93	08.95–12.96	B 5202 S	5	ZM 036	ZSE 037	
2.0	2.0	105	08.95–12.96	B 5204 F	5	ZM 036	ZSE 037	
2.0 Turbo	2.0	155	08.95–12.96	B 5204 T/B 5204 FT	5	ZM 036	ZSE 037	
2.3 T5	2.3	166	08.95–12.96	B 5234 FT	5	ZM 036	ZSE 037	
2.3 T5-R	2.3	184	08.95–12.96	B 5234 T4	5	ZM 036	ZSE 037	
2.5	2.4	103	08.92–07.94	B 5252	5		ZSE 037	
2.5	2.4	106	08.95–12.96	B 5252 S	5	ZM 036	ZSE 037	
2.5	2.4	125	08.95–12.96	B 5254 S	5	ZM 036	ZSE 037	
2.5 AWD	2.4	142	09.96–12.96	B 5254 T	5	ZM 036	ZSE 037	
<b>940</b>								
2.0	2.0	82	01.92–07.94	B 200 F	4	ZM 040	ZS 119	
2.3	2.3	85	08.92–07.94	B 230 FD	4	ZM 040	ZS 119	
2.3	2.3	90	08.90–12.94	B 230 G , B 230 E	4		ZS 119	
2.3	2.3	96	08.90–12.94	B 230 G/B 230 FB	4	ZM 040	ZS 119	
2.3	2.3	114	08.90–07.91	B 234 F /B 234 G	4	ZM 040	ZS 119	
2.3 Turbo	2.3	121	08.90–07.94	B 230 FT	4	ZM 040	ZS 119	
<b>940 Kombi</b>								
2.0	2.0	82	01.92–07.94	B 200 F	4	ZM 040	ZS 119	
2.3	2.3	85	08.92–07.94	B 230 FD	4	ZM 040	ZS 119	
2.3	2.3	96	08.90–12.94	B 230 FB	4	ZM 040	ZS 119	
2.3	2.3	114	08.90–07.91	B 234 F	4	ZM 040	ZS 119	
2.3 Turbo	2.3	121	08.90–07.94	B 230 FT	4	ZM 040	ZS 119	
<b>940 II</b>								
2.3	2.3	85	08.94–07.95	B 230 FD	4	ZM 040	ZS 119	
2.3	2.3	96	08.94–10.98	B 230 FB	4	ZM 040	ZS 119	
2.3 ti	2.3	99	01.95–10.98	B 230 FK	4	ZM 040	ZS 119	
2.3 Turbo	2.3	121	08.94–10.98	B 230 FT	4	ZM 040	ZS 119	
<b>940 II Kombi</b>								
2.3	2.3	85	08.94–07.95	B 230 FD	4	ZM 040	ZS 119	
2.3	2.3	96	08.94–10.98	B 230 FB	4	ZM 040	ZS 119	
2.3 ti	2.3	99	01.95–10.98	B 230 FK	4	ZM 040	ZS 119	
2.3 Turbo	2.3	121	08.94–10.98	B 230 FT	4	ZM 040	ZS 119	
<b>C30</b>								
1.6	1.6	74	10.06–	B 4164 S3	4		ZS 387	
2.4 i	2.4	125	10.06–	B 5244 S4	5		ZSE 055	
T5	2.5	162	10.06–07.07	B 5254 T3	5		ZSE 055	
T5	2.5	169	03.07–	B 5254 T7	5		ZSE 055	
<b>C70 I Cabriolet</b>								
2.0	2.0	132	03.98–07.98	B 5204 T2	5		ZSE 037	
2.0 T	2.0	120	03.00–10.05	B 5204 T4	5		ZSE 019	
2.0 T	2.0	166	08.98–10.05	B 5204 T3	5		ZSE 019	
2.3 T5	2.3	176	09.98–10.05	B 5234 T3	5		ZSE 019	
2.3 T5	2.3	180	07.02–10.05	B 5234 T9	5		ZSE 019	
2.4 T	2.4	147	07.02–10.05	B 5244 T7	5		ZSE 019	
2.5	2.4	125	06.98–03.99	B 5254 S	5	ZM 036		
2.5	2.4	125	03.99–10.05	B 5254 S	5		ZSE 019	
2.5 T	2.4	142	08.98–10.05	B 5254 T/B 5244 T	5		ZSE 019	
<b>C70 I Coupe</b>								
2.0	2.0	132	03.97–07.98	B 5204 T2	5	ZM 036	ZSE 037	
2.0 T	2.0	120	03.00–09.02	B 5204 T4	5		ZSE 019	
2.0 T	2.0	166	03.97–07.98	B 5204 T3	5	ZM 036	ZSE 037	
2.0 T	2.0	166	08.98–09.02	B 5204 T3	5		ZSE 019	
2.3 T-5	2.3	176	03.97–07.98	B 5234 T3	5	ZM 036	ZSE 037	
2.3 T-5	2.3	176	08.98–09.02	B 5234 T3	5		ZSE 019	
2.5	2.4	121	03.99–09.02	B 5254 S	5		ZSE 019	
2.5	2.4	125	05.99–09.02	B 5244 S/B 5254 S	5		ZSE 019	
2.5 T	2.4	142	01.98–07.98	B 5254 T/B 5244 T	5	ZM 036	ZSE 037	
2.5 T	2.4	142	08.98–09.02	B 5254 T/B 5244 T	5		ZSE 019	



kW

**VOLVO****C70 II Cabriolet**

2.4	2.4	103	03.06-	B 5244 S5	5	<b>ZSE 055</b>
2.4 i	2.4	125	03.06-	B 5244 S4	5	<b>ZSE 055</b>
T5	2.5	162	03.06-07.07	B 5254 T3	5	<b>ZSE 055</b>
T5	2.5	169	03.07-	B 5254 T7	5	<b>ZSE 055</b>

**S40 I**

1.6	1.6	77	09.95-08.99	B 4164 S	4	<b>ZS 254</b> <sup>120</sup>
1.6	1.6	77	09.95-08.99	B 4164 S	4	<b>ZS 255</b> <sup>121</sup>
1.6	1.6	80	03.99-12.03	B 4164 S2	4	<b>ZS 429</b>
1.8	1.7	85	07.95-08.99	B 4184 S3/B 4184 S	4	<b>ZS 254</b> <sup>120</sup>
1.8	1.7	85	07.95-08.99	B 4184 S3/B 4184 S	4	<b>ZS 255</b> <sup>121</sup>
1.8	1.8	90	03.99-12.03	B 4184 S2/B 4184 S9	4	<b>ZS 245</b> <sup>120</sup>
1.8	1.8	90	03.99-12.03	B 4184 S2/B 4184 S9	4	<b>ZS 246</b> <sup>121</sup>
1.8	1.8	90	03.99-12.03	B 4184 S2	4	<b>ZS 429</b>
1.9 T4	1.9	147	05.97-07.00	B 4194 T/B 4194 T2	4	<b>ZS 429</b>
2.0	1.9	100	04.99-12.03	B 4204 S2	4	<b>ZS 429</b>
2.0	1.9	103	07.95-08.99	B 4204 S	4	<b>ZS 254</b> <sup>120</sup>
2.0	1.9	103	07.95-08.99	B 4204 S	4	<b>ZS 255</b> <sup>121</sup>
2.0 T	1.9	118	10.97-07.00	B 4204 T	4	<b>ZS 429</b>
2.0 T	1.9	120	06.01-12.03	B 4204 T3	4	<b>ZS 429</b>
2.0 T	1.9	121	07.00-06.01	B 4204 T2/B 4204 T3	4	<b>ZS 429</b>
2.0 T4	1.9	147	07.00-12.03	B 4204 T5	4	<b>ZS 429</b>

**S40 II**

1.6	1.6	74	01.05-	B 4164 S3 Fgst.Nr.106167 →	4	<b>ZS 387</b>
2.4	2.4	103	01.04-	B 5244 S5	5	<b>ZSE 055</b>
2.4	2.4	125	01.04-	B 5244 S	5	<b>ZSE 055</b>
T5	2.5	162	01.04-07.07	B 5254 T3	5	<b>ZSE 055</b>
T5	2.5	169	03.07-	B 5254 T7	5	<b>ZSE 055</b>
T5 AWD	2.5	162	04.04-07.07	B 5254 T3	5	<b>ZSE 055</b>
T5 AWD	2.5	169	03.07-	B 5254 T7	5	<b>ZSE 055</b>

**S60**

2.0 T	2.0	132	08.04-04.10	B 5204 T5	5	<b>ZSE 055</b>
2.0 T	2.0	132	09.01-07.04	B 5204 T5	5	<b>ZSE 019</b>
2.4	2.4	103	11.00-04.10	B 5244 S2	5	<b>ZSE 019</b>
2.4	2.4	125	11.00-04.10	B 5244 S	5	<b>ZSE 019</b>
2.4 Bifuel	2.4	103	06.02-04.10	B 5244 SG2	5	<b>ZSE 019</b>
2.4 T	2.4	147	08.03-04.10	B 5244 T3	5	<b>ZSE 055</b>
2.4 T	2.4	147	11.00-07.03	B 5244 T3	5	<b>ZSE 019</b>
2.4 T5	2.4	191	04.04-04.10	B 5244 T5	5	<b>ZSE 055</b>
2.5 T	2.5	154	02.04-04.10	B 5254 T2	5	<b>ZSE 019</b>
R 2,5 T AWD	2.5	221	03.03-07.07	B 5254 T4	5	<b>ZSE 055</b>
T5	2.3	184	11.00-04.10	B 5234 T3	5	<b>ZSE 019</b>

**S70**

2.0	2.0	93	01.97-11.00	B 5202 S	5	<b>ZM 036</b> <b>ZSE 037</b>
2.0	2.0	105	01.97-07.98	B 5204 F	5	<b>ZM 036</b> <b>ZSE 037</b>
2.0	2.0	132	01.97-07.98	B 5204 T2	5	<b>ZM 036</b> <b>ZSE 037</b>
2.0 Turbo	2.0	155	01.97-07.98	B 5204 T	5	<b>ZM 036</b> <b>ZSE 037</b>
2.0 Turbo	2.0	166	01.97-08.98	B 5204 T3	5	<b>ZM 036</b> <sup>283</sup>
2.0 Turbo	2.0	166	01.97-11.00	B 5204 T3	5	<b>ZSE 019</b>
2.3 T-5	2.3	176	01.97-07.98	B 5234 T3	5	<b>ZM 036</b> <b>ZSE 037</b>
2.3 T-5	2.3	176	08.98-11.00	B 5234 T3	5	<b>ZSE 019</b>
2.3 Turbo	2.3	184	01.97-07.98	B 5234 FT+	5	<b>ZM 036</b> <b>ZSE 037</b>
2.4	2.4	103	08.99-11.00	B 5244 SG/B 5244 S2	5	<b>ZSE 019</b>
2.4	2.4	125	01.97-07.98	B 5244 S/B 5254 S	5	<b>ZM 036</b> <b>ZSE 037</b>
2.4	2.4	125	08.98-11.00	B 5244 S/B 5254 S	5	<b>ZSE 019</b>
2.4 T5 AWD	2.4	142	08.98-04.99	B 5254 T	5	<b>ZSE 019</b>
2.4 Turbo	2.4	142	01.97-07.98	B 5254 T/B 5244 T	5	<b>ZM 036</b> <b>ZSE 037</b>
2.4 Turbo	2.4	142	08.98-11.00	B 5254 T/B 5244 T	5	<b>ZSE 019</b>
2.5	2.4	106	01.97-11.00	B 5252 FS/B 5252 S	5	<b>ZM 036</b> <b>ZSE 037</b>
2.5	2.4	121	06.98-07.98	B 5254 S	5	<b>ZM 036</b> <b>ZSE 037</b>
2.5	2.4	121	08.98-11.00	B 5254 S	5	<b>ZSE 019</b>



kW



## VOLVO

## S70

2.5 Bifuel	2.4	106	10.98–11.00	GB 5252 S	5	ZM 036	ZSE 037
------------	-----	-----	-------------	-----------	---	--------	---------

## S80 I

2.0	2.0	120	06.98–07.06	B 5204 T4	5		ZSE 019
2.0 T	2.0	132	12.99–07.04	B 5204 T5	5		ZSE 019
2.0 T	2.0	132	08.04–07.06	B 5204 T5	5		ZSE 055
2.0 T	2.0	166	06.98–07.06	B 5204 T3	5		ZSE 019
2.4	2.4	103	01.99–07.06	B 5244 S2	5		ZSE 019
2.4	2.4	125	01.99–07.06	B 5244 S	5		ZSE 019
2.4 Bifuel	2.4	103	09.01–07.06	B 5244 SG2	5		ZSE 019
2.4 T	2.4	147	06.00–07.06	B 5244 T3	5		ZSE 019
2.4 T5 AWD	2.4	147	04.00–09.03	B 5244 T3	5		ZSE 019
2.5 T AWD	2.5	154	07.03–07.06	B 5254 T2	5		ZSE 019
2.8 T6	2.8	200	05.98–07.06	B 6284 T	6		ZSE 019
2.9	2.9	147	03.99–07.06	B 6294 S	6		ZSE 019
2.9	2.9	150	05.98–07.06	B 6304 S3	6		ZSE 019
3.0	2.9	144	06.01–07.06	B 6294 S2	6		ZSE 019
3.0 T6	2.9	200	06.01–07.06	B 6294 T	6		ZSE 019

## S80 II

2.5 T	2.5	147	03.06–	B 5254 T6	5		ZSE 055
2.5 T	2.5	170	01.10–	B 5254 T10	5		ZSE 055
2.5 T FlexFuel	2.5	147	05.08–	B 5254 T8	5		ZSE 055
2.5 T FlexFuel	2.5	170	01.10–	B 5254 T11	5		ZSE 055

## V40 Kombi

1.6	1.6	77	12.95–08.99	B 4164 S	4		ZS 254 <sup>120</sup>
1.6	1.6	77	12.95–08.99	B 4164 S	4		ZS 255 <sup>121</sup>
1.6	1.6	80	03.99–06.04	B 4164 S2	4		ZS 245 <sup>120</sup>
1.6	1.6	80	03.99–06.04	B 4164 S2	4		ZS 246 <sup>121</sup>
1.6	1.6	80	03.99–06.04	B 4164 S2	4		ZS 429
1.8	1.7	85	07.95–08.99	B 4184 S3/B 4184 S	4		ZS 254 <sup>120</sup>
1.8	1.7	85	07.95–08.99	B 4184 S3/B 4184 S	4		ZS 255 <sup>121</sup>
1.8	1.8	90	03.99–06.04	B 4184 S2/B 4184 S9	4		ZS 254 <sup>120</sup>
1.8	1.8	90	03.99–06.04	B 4184 S2/B 4184 S9	4		ZS 255 <sup>121</sup>
1.8	1.8	90	03.99–06.04	B 4184 S2	4		ZS 429
1.8 i	1.8	90	06.01–06.04	B 4184 SJ	4		ZS 429
1.8 i	1.8	92	03.98–06.04	B 4184 SM	4		ZS 245 <sup>120</sup>
1.8 i	1.8	92	03.98–06.04	B 4184 SM	4		ZS 246 <sup>121</sup>
1.9 T4	1.9	147	05.97–07.00	B 4194 T	4		ZS 429
2.0	1.9	100	07.95–06.04	B 4204 S2/B 4204 S	4		ZS 245 <sup>120</sup>
2.0	1.9	100	07.95–06.04	B 4204 S2/B 4204 S	4		ZS 246 <sup>121</sup>
2.0	1.9	103	07.95–08.99	B 4204 S	4		ZS 254 <sup>120</sup>
2.0	1.9	103	07.95–08.99	B 4204 S	4		ZS 255 <sup>121</sup>
2.0 T	1.9	118	10.97–07.00	B 4204 T	4		ZS 429
2.0 T	1.9	120	06.01–06.04	B 4204 T3	4		ZS 429
2.0 T	1.9	121	07.99–06.01	B 4204 T2	4		ZS 429
2.0 T4	1.9	147	07.00–06.04	B 4204 T5	4		ZS 429

## V50

1.6	1.6	74	01.05–	B 4164 S3 Fgst.Nr.105440→	4		ZS 387
2.4	2.4	103	04.04–	B 5244 S5	5		ZSE 055
2.4	2.4	125	04.04–	B 5244 S	5		ZSE 055
T5	2.5	162	04.04–07.07	B 5254 T3	5		ZSE 055
T5	2.5	169	03.07–	B 5254 T7	5		ZSE 055
T5 AWD	2.5	162	04.04–07.07	B 5254 T3	5		ZSE 055
T5 AWD	2.5	169	03.07–	B 5254 T7	5		ZSE 055

## V70 I

2.0	2.0	93	01.97–03.00	B 5202 S	5	ZM 036	ZSE 037
2.0	2.0	105	08.98–03.00	B 5204 F	5		ZSE 019
2.0	2.0	105	01.97–07.98	B 5204 F	5	ZM 036	ZSE 037
2.0	2.0	132	01.97–07.98	B 5204 T2	5	ZM 036	ZSE 037
2.0 Turbo	2.0	155	08.98–03.00	B 5204 T	5		ZSE 019
2.0 Turbo	2.0	155	01.97–07.98	B 5204 T	5	ZM 036	ZSE 037



kW

**VOLVO**

<b>V70 I</b>							
2.0 Turbo	2.0	166	08.98–03.00	B 5204 T3	5		<b>ZSE 019</b>
2.0 Turbo	2.0	166	01.97–07.98	B 5204 T3	5	<b>ZM 036</b>	<b>ZSE 037</b>
2.0 Turbo AWD	2.0	166	08.98–03.00	B 5204 T3	5		<b>ZSE 019</b>
2.0 Turbo AWD	2.0	166	01.97–03.00	B 5204 T3	5	<b>ZM 036</b>	<b>ZSE 037</b>
2.3 T AWD	2.3	184	04.97–07.98	B 5234 FT+	5	<b>ZM 036</b>	<b>ZSE 037</b>
2.3 T-5	2.3	176	08.98–03.00	B 5234 T3	5		<b>ZSE 019</b>
2.3 T-5	2.3	176	01.97–07.98	B 5234 T3	5	<b>ZM 036</b>	<b>ZSE 037</b>
2.3 T-5 AWD	2.3	176	08.98–03.00	B 5234 T3	5		<b>ZSE 019</b>
2.3 T-5 AWD	2.3	176	01.97–07.98	B 5234 T3	5	<b>ZM 036</b>	<b>ZSE 037</b>
2.3 Turbo	2.3	184	01.97–03.00	B 5234 FT+	5	<b>ZM 036</b>	<b>ZSE 037</b>
2.4	2.4	103	08.99–05.00	B 5244 SG2/B 5244 S2	5		<b>ZSE 019</b>
2.4	2.4	125	08.98–05.00	B 5244 S/B 5254 S	5		<b>ZSE 019</b>
2.4	2.4	125	01.97–07.98	B 5244 S/B 5254 S	5	<b>ZM 036</b>	<b>ZSE 037</b>
2.4 Turbo	2.4	142	01.97–03.00	B 5254 T/B 5244 T	5	<b>ZM 036</b>	<b>ZSE 019</b>
2.4 Turbo	2.4	142	01.97–03.00	B 5254 T/B 5244 T	5	<b>ZM 036</b>	<b>ZSE 037</b>
2.5	2.4	106	01.97–03.00	B 5252 S	5	<b>ZM 036</b>	<b>ZSE 037</b>
2.5	2.4	121	06.98–03.00	B 5254 S	5	<b>ZM 036</b>	<b>ZSE 019</b>
2.5	2.4	121	06.98–03.00	B 5254 S	5	<b>ZM 036</b>	<b>ZSE 037</b>
2.5 Bifuel	2.4	106	10.98–08.99	GB 5252 S	5	<b>ZM 036</b>	<b>ZSE 037</b>
2.5 Turbo AWD	2.4	142	01.97–05.00	B 5254 T/B 5244 T	5	<b>ZM 036</b>	<b>ZSE 019</b>
2.5 Turbo AWD	2.4	142	01.97–05.00	B 5254 T/B 5244 T	5	<b>ZM 036</b>	<b>ZSE 037</b>
<b>V70 II</b>							
2.0 T	2.0	132	07.01–07.07	B 5204 T5	5		<b>ZSE 055</b>
2.0 T	2.0	132	07.01–08.07	B 5204 T5	5		<b>ZSE 019</b>
2.3 T5	2.3	184	03.00–08.07	B 5234 T3/B 5234 T4	5		<b>ZSE 019</b>
2.4	2.4	103	03.00–08.07	B 5244 S2	5		<b>ZSE 019</b>
2.4	2.4	125	03.00–08.07	B 5244 S	5		<b>ZSE 019</b>
2.4 Bifuel	2.4	103	09.01–08.07	B 5244 SG	5		<b>ZSE 019</b>
2.4 T	2.4	147	03.00–08.07	B 5244 T3	5		<b>ZSE 019</b>
2.4 T AWD	2.4	147	09.01–08.07	B 5244 T3	5		<b>ZSE 019</b>
2.4 T5	2.4	191	04.04–07.07	B 5244 T5	5		<b>ZSE 055</b>
2.5 T	2.5	154	04.04–08.07	B 5254 T2	5		<b>ZSE 019</b>
2.5 T AWD	2.5	154	09.02–08.07	B 5254 T2	5		<b>ZSE 019</b>
R 2,5 T AWD	2.5	221	03.03–07.07	B 5254 T4	5		<b>ZSE 055</b>
<b>V70 III</b>							
2.5 T	2.5	147	08.07–	B 5254 T6	5		<b>ZSE 055</b>
2.5 T	2.5	170	01.10–	B 5254 T10	5		<b>ZSE 055</b>
2.5 T FlexiFuel	2.5	147	05.08–	B 5254 T8	5		<b>ZSE 055</b>
2.5 T FlexiFuel	2.5	170	10.09–	B 5254 T11	5		<b>ZSE 055</b>
<b>XC70 CROSS COUNTRY</b>							
2.4 T XC AWD	2.4	147	03.00–09.02	B 5244 T3	5		<b>ZSE 019</b>
2.5 T XC AWD	2.5	154	09.02–08.07	B 5254 T2	5		<b>ZSE 019</b>
<b>XC90</b>							
2.5 T	2.5	154	10.02–	B 5254 T2	5		<b>ZSE 019</b>
T6	2.9	200	10.02–	B 6294 T	6		<b>ZSE 019</b>

**VW AG**

<b>AMAROK</b>							
2.0 TSI	2.0	118	12.10–	CFPA	4		<b>ZSE 033<sup>202</sup></b>
2.0 TSI	2.0	118	12.10–	CFPA	4		<b>ZSE 142<sup>202</sup></b>
<b>BEETLE</b>							
1.2 TSI	1.2	77	07.11–	CBZB	4		<b>ZSE 003</b>
1.4 TSI	1.4	118	04.11–	CAVD	4		<b>ZSE 030</b>
2.0 TSI	2.0	147	04.11–	CBFA/CCZA/CCTA	4		<b>ZSE 033<sup>202</sup></b>
2.0 TSI	2.0	147	04.11–	CBFA/CCZA/CCTA	4		<b>ZSE 142<sup>202</sup></b>
<b>BORA</b>							
1.4 16V	1.4	55	03.00–05.05	AHW/AXP/APE/AKQ	4		<b>ZSE 003</b>
1.4 16V	1.4	55	03.00–05.05	BCA	4		<b>ZSE 030</b>
1.6	1.6	74	10.98–05.05	AKL/APF/AEH	4		<b>ZSE 003</b>
1.6	1.6	75	08.00–05.05	AVU/BFQ/BJH	4		<b>ZSE 003</b>
1.6 16V	1.6	77	05.00–05.05	ATN , AUS	4		<b>ZSE 003</b>



kW

**VW AG**

<b>BORA</b>							
1.6 16V	1.6	77	05.00-05.05	AZD , BCB	4		<b>ZSE 030</b>
1.6 FSI	1.6	81	01.02-05.05	BAD	4		<b>ZSE 030</b>
1.8	1.8	92	10.98-05.05	AGN	4		<b>ZSE 003</b>
1.8 4motion	1.8	92	02.99-05.05	AGN	4		<b>ZSE 003</b>
1.8 T	1.8	110	05.00-05.05	AGU	4	<b>ZM 062</b>	<b>ZS 016 ZLE 276</b>
1.8 T	1.8	110	05.00-05.05	AUM	4		<b>ZSE 043</b>
2.0	2.0	85	10.98-05.05	AQY , APK , AZH	4		<b>ZSE 003</b>
2.0	2.0	85	10.98-05.05	AZG , AZJ	4		<b>ZSE 029</b>
2.0 4motion	2.0	85	04.00-05.05	AZH	4		<b>ZSE 003</b>
2.0 4motion	2.0	85	04.00-05.05	AZJ	4		<b>ZSE 029</b>
2.3 V5	2.3	110	10.98-10.00	AGZ	5		<b>ZS 037</b>
2.3 V5	2.3	125	10.00-05.05	AQN	5		<b>ZSE 063</b>
2.3 V5 4motion	2.3	110	12.98-10.00	AGZ	5		<b>ZS 037</b>
2.3 V5 4motion	2.3	125	10.00-05.05	AQN	5		<b>ZSE 063</b>
2.8 V6 4motion	2.8	150	03.99-04.01	AQP , AUE	6		<b>ZSE 013</b>
2.8 V6 4motion	2.8	150	05.01-05.03	BDE	6		<b>ZSE 063</b>
<b>BORA Kombi</b>							
1.4 16V	1.4	55	09.01-05.05	AHW/AXP/BCA	4		<b>ZSE 030</b>
1.6	1.6	74	05.99-05.05	AKL/APF/AEH	4		<b>ZSE 003</b>
1.6	1.6	75	08.00-05.05	AVU/BFQ	4		<b>ZSE 003</b>
1.6 16V	1.6	77	02.00-05.05	ATN , AUS	4		<b>ZSE 003</b>
1.6 16V	1.6	77	02.00-05.05	AZD , BCB	4		<b>ZSE 030</b>
1.6 FSI	1.6	81	01.02-05.05	BAD	4		<b>ZSE 030</b>
1.8 4motion	1.8	92	05.99-05.05	AGN	4		<b>ZSE 003</b>
1.8 T	1.8	110	05.00-05.05	AGU	4	<b>ZM 062</b>	<b>ZS 016 ZLE 276</b>
1.8 T	1.8	110	05.00-05.05	AUM	4		<b>ZSE 043</b>
1.8 T	1.8	132	05.02-05.05	AUQ	4		<b>ZSE 043</b>
2.0	2.0	85	05.99-05.05	APK/AZH/AZJ/AQY/AZG	4		<b>ZSE 003</b>
2.0	2.0	85	05.99-05.05	AZG , AZJ	4		<b>ZSE 029</b>
2.0 4motion	2.0	85	04.00-05.05	AZH	4		<b>ZSE 003</b>
2.0 4motion	2.0	85	04.00-05.05	AZJ	4		<b>ZSE 029</b>
2.3 V5	2.3	110	05.99-10.00	AGZ	5		<b>ZS 037</b>
2.3 V5	2.3	125	10.00-05.05	AQN	5		<b>ZSE 063</b>
2.3 V5 4motion	2.3	110	05.99-10.00	AGZ	5		<b>ZS 037</b>
2.3 V5 4motion	2.3	125	10.00-05.05	AQN	5		<b>ZSE 063</b>
2.8 V6 4motion	2.8	150	05.01-05.03	BDE	6		<b>ZSE 063</b>
2.8 V6 4motion	2.8	150	05.99-05.05	AQP , AUE	6		<b>ZSE 013</b>
2.8 VR6	2.8	150	03.00-05.00	AUE	6		<b>ZSE 013</b>
<b>CORRADO</b>							
1.8 16V	1.8	100	04.89-07.92	KR	4	<b>ZM 012</b>	<b>ZS 123</b>
1.8 G60	1.8	118	09.88-09.93	PG	4	<b>ZM 012</b>	<b>ZS 124</b>
2.0 i	2.0	85	04.93-12.95	ADY, 2E	4		<b>ZSE 001</b>
2.0 i 16V	2.0	100	08.91-12.95	9A	4	<b>ZM 013</b>	<b>ZSE 001</b>
2.9 VR6	2.9	140	04.93-12.95	ABV	6		<b>ZSE 004</b>
<b>DERBY</b>							
1.3	1.3	55	09.82-12.84	GK	4		<b>ZS 124</b>
<b>EOS</b>							
1.4 TSI	1.4	90	11.07-	CAXA	4		<b>ZSE 030</b>
1.4 TSI	1.4	118	05.08-	CAVD/CTHD	4		<b>ZSE 030</b>
1.6 FSI	1.6	85	06.06-05.08	BLF	4		<b>ZSE 030</b>
2.0 FSI	2.0	110	03.06-05.08	BVZ/BVY	4		<b>ZSE 033</b> <sup>202</sup>
2.0 FSI	2.0	110	03.06-05.08	BVZ/BVY	4		<b>ZSE 142</b> <sup>202</sup>
2.0 TFSI	2.0	147	03.06-	BWA/BPY/CBFA/CCZA/CAWB/CCTA	4		<b>ZSE 033</b> <sup>202</sup>
2.0 TFSI	2.0	147	03.06-	BWA/BPY/CBFA/CCZA/CAWB/CCTA	4		<b>ZSE 142</b> <sup>202</sup>
2.0 TSI	2.0	155	11.09-	CCZB	4		<b>ZSE 033</b> <sup>202</sup>
2.0 TSI	2.0	155	11.09-	CCZB	4		<b>ZSE 142</b> <sup>202</sup>
3.2 V6	3.2	184	06.06-	BUB	6		<b>ZSE 044</b>
3.6 V6	3.6	191	05.09-	CDVA	6		<b>ZSE 041</b>





kW



## VW AG

## FOX

1.2	1.2	40	04.05-	BMD/CHFB Fgst.Nr.5Z-60009 326 , 5Z-64081 327→ Fgst.Nr.→5Z-80016 409 , 5Z-94149 953	3		ZSE 059 <sup>202</sup>
1.2	1.2	44	09.10-	CHFA	3		ZSE 059
1.4	1.4	55	04.05-	BKR	4		ZSE 003
1.6	1.6	74	10.03-	BAH , BPA , BLH , CCRA , CFZA	4		ZSE 003
1.6 Total Flex	1.6	74	10.03-	BPA , CCRA	4		ZSE 003

## GOLF I

1.3	1.3	40	08.83-07.86	HK	4	ZM 002	ZS 115
1.6	1.6	53	04.86-02.90	RE	4		ZS 124
1.6	1.6	55	08.83-04.92	EW/HN	4		ZS 124
1.8	1.8	66	08.83-09.92	EX	4		ZS 124
1.8	1.8	70	08.88-04.93	JH	4		ZS 123
1.8	1.8	70	08.84-07.88	JH	4		ZS 124
1.8	1.8	72	08.89-03.93	2H	4		ZS 124
1.8	1.8	82	08.82-07.84	EV/PB/DX	4		ZS 115
1.8	1.8	82	08.84-12.89	EV/PB/DX	4		ZS 124
1.8	1.8	82	08.83-07.84	DX	4		ZS 115
1.8	1.8	82	08.84-12.92	DX	4		ZS 124

## GOLF II

1.0	1.0	33	11.83-07.84	GN	4		ZS 115
1.0	1.0	33	11.83-08.85	GN	4	ZM 002	
1.0	1.0	37	08.85-07.87	HZ	4	ZM 002	ZS 124
1.0	1.0	37	08.87-10.91	HZ	4	ZM 012	ZS 123
1.3	1.3	37	08.85-09.86	NU	4	ZM 002	ZS 123
1.3	1.3	37	10.86-12.87	NU	4	ZM 012	
1.3	1.3	40	08.83-09.86	MH/HK	4	ZM 002	
1.3	1.3	40	10.86-06.87	MH/HK	4	ZM 012	
1.3	1.3	40	08.83-06.87	HK	4		ZS 115
1.3	1.3	40	08.83-06.87	MH	4		ZS 123
1.3	1.3	43	08.83-10.86	GT	4	ZM 002	
1.3 KAT	1.3	40	06.86-07.89	NZ/2G/MH	4		ZS 123
1.3 KAT	1.3	40	06.86-09.86	NZ/2G/MH	4	ZM 002	
1.3 KAT	1.3	40	08.89-09.90	NZ/2G	4		ZS 124
1.3 KAT	1.3	40	10.86-12.92	NZ/2G/MH	4	ZM 012	
1.3 KAT	1.3	40	10.90-12.92	NZ/2G	4		ZSE 001 <sup>202</sup>
1.3 KAT	1.3	40	10.90-12.92	NZ/2G	4		ZSE 002 <sup>202</sup>
1.6	1.6	51	10.86-07.88	PN	4		ZS 124
1.6	1.6	51	10.86-12.92	PN	4	ZM 012	
1.6	1.6	51	08.88-12.92	PN	4		ZS 123
1.6	1.6	51	08.86-07.88	PN/EZA	4		ZS 124
1.6	1.6	51	08.86-07.91	PN/EZA	4	ZM 012	
1.6	1.6	51	08.88-07.91	PN/EZA	4		ZS 123
1.6	1.6	53	02.86-09.86	RF	4	ZM 002	
1.6	1.6	53	10.86-10.91	RF	4	ZM 012	
1.6	1.6	53	02.86-07.88	RF	4		ZS 124
1.6	1.6	53	08.88-10.91	RF	4		ZS 123
1.6	1.6	55	08.83-07.84	HM/ABN/EZ	4		ZS 115
1.6	1.6	55	01.85-07.88	HM/ABN/EZ	4		ZS 124
1.6	1.6	55	08.88-07.92	HM/ABN/EZ	4		ZS 123
1.6	1.6	55	08.83-09.86	HM/ABN/EZ	4	ZM 002	
1.6	1.6	55	10.86-07.92	HM/ABN/EZ	4	ZM 012	
1.8	1.8	62	08.86-09.86	RH	4	ZM 002 <sup>202</sup>	
1.8	1.8	62	10.86-01.90	RH	4	ZM 012 <sup>202</sup>	
1.8	1.8	62	08.86-01.90	RH	4		ZS 123 <sup>202</sup>
1.8	1.8	62	08.86-01.90	RH	4		ZS 124 <sup>202</sup>
1.8	1.8	66	08.84-09.86	GX/GU/HV	4	ZM 002	ZS 124
1.8	1.8	66	10.86-10.91	GX/GU/HV	4	ZM 012	ZS 124
1.8 GTI	1.8	79	08.85-09.86	RD	4	ZM 002	ZS 124
1.8 GTI	1.8	79	10.86-10.87	RD	4	ZM 012	ZS 124
1.8 GTI	1.8	79	08.85-10.87	RD	4		ZS 124



kW

**VW AG**

<b>GOLF II</b>							
1.8 GTI	1.8	82	08.83-09.86	EV/GZ/PB/DX	4	ZM 002	
1.8 GTI	1.8	82	10.86-10.91	EV/GZ/PB/DX	4	ZM 012	
1.8 GTI	1.8	82	08.87-10.91	PB	4		ZS 124
1.8 GTI 16V	1.8	95	02.86-09.86	PL	4	ZM 002	
1.8 GTI 16V	1.8	95	10.86-10.91	PL	4	ZM 012	
1.8 GTI 16V	1.8	95	02.86-07.87	PL	4		ZS 120
1.8 GTI 16V	1.8	95	08.87-10.91	PL	4		ZS 123
1.8 GTI 16V	1.8	102	02.86-09.86	KR	4	ZM 002	ZS 123
1.8 GTI 16V	1.8	102	10.86-06.90	KR	4	ZM 012	ZS 123
1.8 GTI 16V	1.8	102	02.86-06.90	KR	4		ZS 123
1.8 GTI G60	1.8	118	04.90-07.91	PG	4	ZM 012	
1.8 GTI G60 Syncro	1.8	118	08.88-07.91	PG/1H	4	ZM 012	ZS 124
1.8 GTI KAT	1.8	79	01.87-10.91	PF	4	ZM 012	ZS 123
1.8 i KAT	1.8	66	08.87-10.91	GX/RP	4	ZM 012	ZS 124
1.8 i Syncro KAT	1.8	66	08.87-10.91	RP	4	ZM 012	ZS 124
1.8 Syncro	1.8	66	02.86-07.88	GX	4		ZS 124
1.8 Syncro	1.8	66	08.88-07.91	GU	4		ZS 123
1.8 Syncro	1.8	66	02.86-09.86	GX/GU	4	ZM 002	
1.8 Syncro	1.8	66	10.86-07.91	GX/GU	4	ZM 012	
1.8 Syncro	1.8	72	08.88-07.89	1P	4		ZS 123
1.8 Syncro	1.8	72	08.89-07.91	1P	4	ZM 012	ZS 124
<b>GOLF III</b>							
1.4	1.4	40	11.91-08.97	AEX/ABD	4	ZM 013	ZSE 001
1.4	1.4	44	10.91-08.97	ABD	4	ZM 013	
1.4	1.4	44	10.91-08.97	AEX/ABD	4		ZSE 001
1.6	1.6	55	09.92-08.97	ABU	4	ZM 014	
1.6	1.6	55	09.92-08.97	ABU/AEA/AEE	4		ZSE 001
1.6	1.6	74	07.95-08.97	AEK , AFT	4		ZSE 001 <sup>285</sup>
1.8	1.8	55	11.91-08.97	AAM	4	ZM 013	ZSE 001
1.8	1.8	66	11.91-08.97	ACC/ADZ/ABS	4	ZM 013	
1.8	1.8	66	11.91-08.97	ABS , ADZ	4		ZSE 001
1.8 Syncro	1.8	66	01.93-08.97	ABS	4	ZM 013	ZSE 001
2.0	2.0	85	11.91-08.97	ABA/ADY/AKR/2E/AGG	4	ZM 013	ZSE 001
2.0 GTI 16V	2.0	110	08.92-08.97	ABF	4		ZSE 001
2.0 Syncro	2.0	85	08.95-08.97	AGG	4		ZSE 001
2.8 VR6	2.8	128	01.92-08.97	AAA Fgst.Nr.1H-PB 060 000 , 1H-PW 480 000→	6		ZSE 004
2.9 VR6 Syncro	2.9	140	10.94-08.97	ABV	6		ZSE 004
<b>GOLF III Cabriolet</b>							
1.6	1.6	74	04.97-05.98	AEK , AFT , AKS	4		ZSE 001 <sup>285</sup>
1.8	1.8	55	07.93-05.98	AAM	4	ZM 013	ZSE 001
1.8	1.8	66	07.93-05.98	ABS	4	ZM 013	
1.8	1.8	66	07.93-05.98	ADZ/ABS	4		ZSE 001
2.0	2.0	85	07.93-05.98	ADY/AKR/2E/AGG	4	ZM 013	ZSE 001
<b>GOLF III Variant</b>							
1.4	1.4	40	07.93-04.99	ABD	4	ZM 013	ZSE 001
1.4	1.4	44	07.93-04.99	ABD	4	ZM 013	
1.4	1.4	44	07.93-04.99	AEX/ABD/APQ	4		ZSE 001
1.6	1.6	55	07.93-12.97	ABU	4	ZM 014	
1.6	1.6	55	07.93-12.97	ABU/AEA/AEE	4		ZSE 001
1.6	1.6	74	07.94-04.99	AEK , AFT	4		ZSE 001 <sup>285</sup>
1.8	1.8	55	07.93-04.99	ANN/AAM	4	ZM 013	ZSE 001
1.8	1.8	66	07.93-04.99	ABS	4	ZM 013	
1.8	1.8	66	07.93-04.99	ADZ/ABS/ANP	4		ZSE 001
1.8 Syncro	1.8	66	10.94-04.99	ADZ	4		ZSE 001
2.0	2.0	85	07.93-04.99	ADY/AKR/2E/AGG	4	ZM 013	ZSE 001
2.9 VR6	2.9	140	10.94-12.97	ABV	6		ZSE 004
2.9 VR6 Syncro	2.9	140	10.94-12.97	ABV	6		ZSE 004
<b>GOLF IV</b>							
1.4 16V	1.4	55	08.97-06.05	AHW/AXP/APE/AKQ	4		ZSE 003
1.4 16V	1.4	55	08.97-06.05	BCA	4		ZSE 030



kW

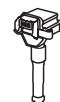

## VW AG

## GOLF IV

1.6	1.6	74	08.97-02.00	AKL/APF/AEH	4	ZSE 003	
1.6	1.6	75	08.00-06.05	AVU , BFQ	4	ZSE 003	
1.6 16V	1.6	77	02.00-06.05	ATN , AUS	4	ZSE 003	
1.6 16V	1.6	77	02.00-06.05	AZD , BCB	4	ZSE 030	
1.6 FSI	1.6	81	01.02-06.05	BAD	4	ZSE 030	
1.8	1.8	92	08.97-06.05	AGN	4	ZSE 003	
1.8 4motion	1.8	92	05.98-06.05	AGN	4	ZSE 003	
1.8 T	1.8	110	08.97-06.05	AGU	4	ZS 016	ZLE 276
1.8 T	1.8	110	08.97-06.05	ARZ , AWD Fgst.Nr.→1J-Y-900 000	4	ZSE 009	
1.8 T	1.8	110	05.01-06.05	AUM , AWD Fgst.Nr.1J-1-000 001→	4	ZSE 043	
1.8 T GTI	1.8	132	08.01-06.05	AUQ	4	ZSE 043	
2.0	2.0	85	07.98-05.04	APK/AZJ/AQY/AZG	4	ZSE 003	
2.0	2.0	85	07.98-05.04	AZG , AZJ	4	ZSE 029	
2.0 4motion	2.0	85	10.00-06.01	AZH	4	ZSE 003	
2.0 4motion	2.0	85	10.00-06.05	AZJ	4	ZSE 029	
2.3 V5	2.3	110	08.97-10.00	AGZ	5	ZS 037	
2.3 V5	2.3	125	10.00-06.05	AQN	5	ZSE 063	
2.3 V5 4motion	2.3	110	12.98-10.00	AGZ	5	ZS 037	
2.3 V5 4motion	2.3	125	10.00-06.05	AQN	5	ZSE 063	
2.8	2.8	128	08.97-09.99	AAA	6	ZSE 004	
2.8 V6 4motion	2.8	150	03.99-06.05	AQP , AUE	6	ZSE 013	
2.8 V6 4motion	2.8	150	05.01-06.05	BDE	6	ZSE 063	
3.2 R32 4motion	3.2	177	09.02-06.05	BFH/BML	6	ZSE 044	

## GOLF IV Cabriolet

1.6	1.6	74	06.98-06.02	AFT/AKS	4	ZM 013	ZSE 001
1.8	1.8	55	06.98-06.02	ANN/AAM	4	ZSE 001	
1.8	1.8	66	06.98-06.02	ADZ/ANP	4	ZSE 001	
2.0	2.0	85	06.98-06.02	AGG, AKR	4	ZSE 001	

## GOLF IV Variant

1.4 16V	1.4	55	05.99-06.06	AHW/AXP/APE/AKQ	4	ZSE 003	
1.4 16V	1.4	55	05.99-06.06	BCA	4	ZSE 030	
1.6	1.6	74	05.99-02.00	AKL/APF/AEH	4	ZSE 003	
1.6	1.6	75	08.00-06.06	AVU/BFQ	4	ZSE 003	
1.6 16V	1.6	77	02.00-06.06	ATN , AUS	4	ZSE 003	
1.6 16V	1.6	77	02.00-06.06	AZD , BCB	4	ZSE 030	
1.6 FSI	1.6	81	01.02-06.06	BAD	4	ZSE 030	
1.8 4motion	1.8	92	05.99-06.06	AGN	4	ZSE 003	
1.8 T	1.8	110	05.00-06.06	AGU	4	ZM 062	ZS 016 ZLE 276
1.8 T	1.8	110	05.00-06.06	ARZ , AWD Fgst.Nr.→1J-Y-900 000	4	ZSE 009	
1.8 T	1.8	110	05.01-06.06	AUM , AWD Fgst.Nr.1J-1-000 001→	4	ZSE 043	
2.0	2.0	85	05.99-06.06	APK , AQY	4	ZSE 003	
2.0	2.0	85	05.99-06.06	AZJ	4	ZSE 029	
2.0 4motion	2.0	85	10.00-06.01	AZH	4	ZSE 003	
2.0 4motion	2.0	85	10.00-06.06	AZJ	4	ZSE 029	
2.0 Bi-Fuel	2.0	85	02.02-06.06	BEH	4	ZSE 003	
2.0 Bi-Fuel	2.0	85	02.02-06.06	BEH	4	ZSE 029	
2.3 V5	2.3	110	05.99-06.06	AGZ	5	ZS 037	
2.3 V5	2.3	125	10.00-06.06	AQN	5	ZSE 063	
2.3 V5 4motion	2.3	110	05.99-06.06	AGZ	5	ZS 037	
2.3 V5 4motion	2.3	125	10.00-06.06	AQN	5	ZSE 063	
2.8 V6 4motion	2.8	150	05.01-06.05	BDE	6	ZSE 063	
2.8 V6 4motion	2.8	150	05.99-06.06	AQP , AUE	6	ZSE 013	

## GOLF PLUS

1.2 TSI	1.2	63	05.10-	CBZA	4	ZSE 003	
1.2 TSI	1.2	77	11.09-	CBZB	4	ZSE 003	
1.4 16V	1.4	55	01.05-	BCA	4	ZSE 030	
1.4 16V	1.4	59	05.06-	CGGA Fgst.Nr.1K-9-400 001→	4	ZSE 030	



kW



<b>VW AG</b>							
<b>GOLF PLUS</b>							
1.4 FSI	1.4	66	07.05–	BLN	4		<b>ZSE 030</b>
1.4 TSI	1.4	90	06.07–	CAXA Fgst.Nr.→1K-8-281 299	4		<b>ZSE 030</b>
1.4 TSI	1.4	103	05.06–06.08	BMV Fgst.Nr.→1K-8-281 299	4		<b>ZSE 030</b>
1.4 TSI	1.4	118	06.08–	CAVD , CNWA	4		<b>ZSE 030</b>
1.4 TSI	1.4	125	05.06–06.08	BLG Fgst.Nr.→1K-8-281 299	4		<b>ZSE 030</b>
1.6	1.6	75	05.05–	CCSA/BSF/CMXA/BSE	4		<b>ZSE 003</b>
1.6 BiFuel	1.6	75	05.09–	CHGA	4		<b>ZSE 003</b>
1.6 FSI	1.6	85	01.05–05.08	BLF	4		<b>ZSE 030</b>
1.6 MultiFuel	1.6	75	11.07–	CCSA/CMXA	4		<b>ZSE 003</b>
2.0 FSI	2.0	110	05.05–06.08	BLY/BLR/BVZ/BVY	4		<b>ZSE 033</b> <sup>202</sup>
2.0 FSI	2.0	110	05.05–06.08	BLY/BLR/BVZ/BVY	4		<b>ZSE 142</b> <sup>202</sup>
<b>GOLF V</b>							
1.4 16V	1.4	55	10.03–05.06	BCA	4		<b>ZSE 030</b>
1.4 16V	1.4	59	05.06–11.08	BUD Fgst.Nr.→1K-8-281 299	4		<b>ZSE 030</b>
1.4 FSI	1.4	66	10.03–07.06	BKG/BLN	4		<b>ZSE 030</b>
1.4 TSI	1.4	90	05.07–11.08	CAXA Fgst.Nr.→1K-8-281 299	4		<b>ZSE 030</b>
1.4 TSI	1.4	103	05.06–11.08	BMV Fgst.Nr.→1K-8-281 299	4		<b>ZSE 030</b>
1.4 TSI	1.4	125	11.05–11.08	BLG Fgst.Nr.→1K-8-281 299	4		<b>ZSE 030</b>
1.6	1.6	75	01.04–11.08	BGU/BSF/BSE	4		<b>ZSE 003</b>
1.6 FSI	1.6	85	10.03–07.08	BLF/BLP/BAG	4		<b>ZSE 030</b>
1.6 MultiFuel	1.6	75	10.07–11.08	CCSA	4		<b>ZSE 003</b>
2.0 FSI	2.0	110	01.04–11.08	BVX/BLX/BLY/BLR/AXW/BVZ/BVY	4		<b>ZSE 033</b> <sup>202</sup>
2.0 FSI	2.0	110	01.04–11.08	BVX/BLX/BLY/BLR/AXW/BVZ/BVY	4		<b>ZSE 142</b> <sup>202</sup>
2.0 FSI 4motion	2.0	110	08.04–11.08	BVX/BLX	4		<b>ZSE 033</b> <sup>202</sup>
2.0 FSI 4motion	2.0	110	08.04–11.08	BVX/BLX	4		<b>ZSE 142</b> <sup>202</sup>
2.0 GTI	2.0	147	10.04–02.09	BWA/BPY/AXX/CBFA/CAWB/CCTA	4		<b>ZSE 033</b> <sup>202</sup>
2.0 GTI	2.0	147	10.04–02.09	BWA/BPY/AXX/CBFA/CAWB/CCTA	4		<b>ZSE 142</b> <sup>202</sup>
2.0 GTI	2.0	169	09.06–12.08	BYD	4		<b>ZSE 033</b> <sup>202</sup>
2.0 GTI	2.0	169	09.06–12.08	BYD	4		<b>ZSE 142</b> <sup>202</sup>
3.2	3.2	184	09.05–11.08	BUB	6		<b>ZSE 044</b>
3.2 R32 4motion	3.2	184	11.05–11.08	BUB	6		<b>ZSE 044</b>
<b>GOLF V Variant</b>							
1.4	1.4	59	06.07–	BUD Fgst.Nr.→1K-8-281 299	4		<b>ZSE 030</b>
1.4 TSI	1.4	90	06.07–	CAXA Fgst.Nr.→1K-8-281 299	4		<b>ZSE 030</b>
1.4 TSI	1.4	103	06.07–	BMV Fgst.Nr.→1K-8-281 299	4		<b>ZSE 030</b>
1.4 TSI	1.4	118	07.08–	CAVD Fgst.Nr.1K-9-400 001→	4		<b>ZSE 030</b>
1.4 TSI	1.4	125	06.07–	BLG Fgst.Nr.→1K-8-281 299	4		<b>ZSE 030</b>
1.6	1.6	75	06.07–	CCSA/BSF/BSE	4		<b>ZSE 003</b>
1.6 MultiFuel	1.6	75	11.07–	CCSA	4		<b>ZSE 003</b>
2.0	2.0	147	06.07–	BWA/CAWB/CCTA	4		<b>ZSE 033</b> <sup>202</sup>
2.0	2.0	147	06.07–	BWA/CAWB/CCTA	4		<b>ZSE 142</b> <sup>202</sup>
<b>GOLF VI</b>							
1.2 TSI	1.2	63	05.10–11.12	CBZA	4		<b>ZSE 003</b>
1.2 TSI	1.2	77	05.09–11.12	CBZB	4		<b>ZSE 003</b>
1.4	1.4	59	10.08–11.12	CGGA Fgst.Nr.1K-9-400 001→	4		<b>ZSE 030</b>
1.4 TSI	1.4	90	10.08–11.12	CAXA	4		<b>ZSE 030</b>
1.4 TSI	1.4	118	10.08–11.12	CTKA/CAVD/CTHD/CNWA	4		<b>ZSE 030</b>
1.6	1.6	75	10.08–11.12	CCSA/BSF/CMXA/BSE	4		<b>ZSE 003</b>
1.6 BiFuel	1.6	75	03.09–11.12	CHGA	4		<b>ZSE 003</b>
1.8 TSI	1.8	118	06.09–01.11	CDAA	4		<b>ZSE 033</b> <sup>202</sup>



kW



**VW AG**

**GOLF VI**

1.8 TSi	1.8	118	06.09-01.11	CDA	4	ZSE 142 <sup>202</sup>
2.0 GTi	2.0	155	04.09-11.12	CCZB	4	ZSE 033 <sup>202</sup>
2.0 GTi	2.0	155	04.09-11.12	CCZB	4	ZSE 142 <sup>202</sup>
2.0 GTi	2.0	173	05.11-11.12	CDLG	4	ZSE 033 <sup>202</sup>
2.0 GTi	2.0	173	05.11-11.12	CDLG	4	ZSE 142 <sup>202</sup>
2.0 R 4motion	2.0	188	11.09-11.13	CRZA/CDLC	4	ZSE 033 <sup>202</sup>
2.0 R 4motion	2.0	188	11.09-11.13	CRZA/CDLC	4	ZSE 142 <sup>202</sup>
2.0 R 4motion	2.0	195	11.09-05.11	CDLA	4	ZSE 033
2.0 R 4motion	2.0	199	11.09-11.12	CDLF	4	ZSE 033 <sup>202</sup>
2.0 R 4motion	2.0	199	11.09-11.12	CDLF	4	ZSE 142 <sup>202</sup>

**GOLF VI Cabriolet**

1.2 TSi	1.2	77	03.11-	CBZB	4	ZSE 003
1.4 TSi	1.4	90	11.11-	CAXA	4	ZSE 030
1.4 TSi	1.4	118	03.11-	CAVD	4	ZSE 030
2.0 TSi	2.0	155	11.11-	CCZB	4	ZSE 033

**GOLF VI Variant**

1.2 TSi	1.2	63	07.10-	CBZA	4	ZSE 003
1.2 TSi	1.2	77	08.09-	CBZB	4	ZSE 003
1.4	1.4	59	07.09-	BUD/CGGA Fgst.Nr.1K-8-281 300→	4	ZSE 030
1.4 TSi	1.4	90	07.09-	CAXA	4	ZSE 030
1.4 TSi	1.4	118	07.09-	CTKA/CAVD/CTHD/CNWA Fgst.Nr.1K-8-281 300→	4	ZSE 030
1.6	1.6	75	07.09-	CCSA/BSF/CMXA/BSE	4	ZSE 003

**GOLF VII**

2.0 GTI	2.0	162	04.13-	CHHB	4	ZSE 068
2.0 GTI	2.0	169	04.13-	CHHA	4	ZSE 068

**JETTA II**

1.3	1.3	40	10.86-06.87	MH/HK	4	ZM 012 <sup>202</sup>
1.3	1.3	40	08.85-06.87	MH	4	ZS 124 <sup>202</sup>
1.3	1.3	40	01.84-09.86	MH/HK	4	ZM 002 <sup>202</sup>
1.3 KAT	1.3	40	06.87-12.91	NZ/2G/MH	4	ZM 002
1.3 KAT	1.3	40	06.87-12.91	NZ/2G/MH	4	ZM 012
1.3 KAT	1.3	40	08.87-12.91	NZ/MH	4	ZS 123
1.3 KAT	1.3	40	06.87-12.91	NZ/2G/MH	4	ZS 124
1.6	1.6	51	10.86-10.91	PN	4	ZM 002 ZS 124
1.6	1.6	51	10.86-10.91	PN	4	ZM 012 ZS 124
1.6	1.6	53	03.86-09.86	RF	4	ZM 002 ZS 124
1.6	1.6	53	10.86-10.91	RF	4	ZM 012 ZS 124
1.6	1.6	55	10.86-07.92	HM/ABN/EZ	4	ZM 012 ZS 124
1.6	1.6	55	01.84-07.92	HM/ABN/EZ	4	ZM 002 ZS 124
1.8	1.8	62	08.86-09.86	RH	4	ZM 002
1.8	1.8	62	10.86-01.90	RH	4	ZM 012
1.8	1.8	62	08.86-01.90	RH	4	ZS 123
1.8	1.8	62	08.86-01.90	RH	4	ZS 124
1.8	1.8	66	08.84-07.89	GX , HV Fgst.Nr.19..E..855001→	4	ZS 124
1.8	1.8	66	08.84-09.86	GX/GU/HV	4	ZM 002 ZS 123
1.8	1.8	66	10.86-10.91	GX/GU/HV	4	ZM 012 ZS 123
1.8	1.8	79	08.85-09.86	RD	4	ZM 002 ZS 124
1.8	1.8	79	10.86-10.87	RD	4	ZM 012 ZS 124
1.8	1.8	82	01.84-09.86	EV/GZ/PB	4	ZM 002 ZS 124
1.8	1.8	82	10.86-10.91	EV/GZ/PB	4	ZM 012 ZS 124
1.8 16V	1.8	95	08.86-07.87	PL	4	ZS 120
1.8 16V	1.8	95	08.87-10.91	PL	4	ZS 124
1.8 16V	1.8	95	08.87-10.91	PL	4	ZS 123
1.8 16V	1.8	95	08.86-09.86	PL	4	ZM 002
1.8 16V	1.8	95	10.86-10.91	PL	4	ZM 012
1.8 16V	1.8	102	06.87-12.89	KR	4	ZM 012 ZS 124
1.8 KAT	1.8	66	08.87-10.91	GX/VP	4	ZM 012 ZS 124
1.8 KAT	1.8	79	01.87-10.91	PF	4	ZM 012 ZS 124
1.8 Syncro	1.8	66	08.87-12.88	RP/GU	4	ZM 012 ZS 124

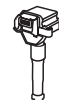
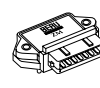

kW

**VW AG**
**JETTA II**

1.8 Syncro	1.8	72	08.88-07.91	1P	4	<b>ZM 012</b>	<b>ZS 124</b>
------------	-----	----	-------------	----	---	---------------	---------------

**JETTA III**

1.4 TSI	1.4	90	05.07-10.10	CAXA	4		<b>ZSE 030</b>
---------	-----	----	-------------	------	---	--	----------------

1.4 TSI	1.4	103	07.06-10.10	BMV Fgst.Nr.→1K-8-281 299	4		<b>ZSE 030</b>
---------	-----	-----	-------------	------------------------------	---	--	----------------

1.4 TSI	1.4	118	07.08-10.10	CAVD	4		<b>ZSE 030</b>
---------	-----	-----	-------------	------	---	--	----------------

1.4 TSI	1.4	125	07.06-10.10	BLG Fgst.Nr.→1K-8-281 299	4		<b>ZSE 030</b>
---------	-----	-----	-------------	------------------------------	---	--	----------------

1.6	1.6	75	10.05-10.10	BGU/CCSA/BSF/BSE	4		<b>ZSE 003</b>
-----	-----	----	-------------	------------------	---	--	----------------

1.6 FSI	1.6	85	09.05-10.10	BLF Fgst.Nr.1K-7-000 000→	4		<b>ZSE 030</b>
---------	-----	----	-------------	------------------------------	---	--	----------------

1.6 MultiFuel	1.6	75	01.08-10.10	CCSA	4		<b>ZSE 003</b>
---------------	-----	----	-------------	------	---	--	----------------

2.0 FSI	2.0	110	08.05-10.10	BLX/BLY/BLR/BVZ/BVY	4		<b>ZSE 033</b> <sup>202</sup>
---------	-----	-----	-------------	---------------------	---	--	-------------------------------

2.0 FSI	2.0	110	08.05-10.10	BLX/BLY/BLR/BVZ/BVY	4		<b>ZSE 142</b> <sup>202</sup>
---------	-----	-----	-------------	---------------------	---	--	-------------------------------

2.0 TFSI	2.0	147	10.05-10.10	BWA/BPY/AXX/CCZA/CBFA/CAWB/CCTA	4		<b>ZSE 033</b> <sup>202</sup>
----------	-----	-----	-------------	---------------------------------	---	--	-------------------------------

2.0 TFSI	2.0	147	10.05-10.10	BWA/BPY/AXX/CBFA/CCZA/CAWB/CCTA	4		<b>ZSE 142</b> <sup>202</sup>
----------	-----	-----	-------------	---------------------------------	---	--	-------------------------------

2.5 FSI	2.5	110	01.06-10.10	BTK/BGP	5		<b>ZSE 142</b>
---------	-----	-----	-------------	---------	---	--	----------------

2.5 FSI	2.5	125	07.08-10.10	CCCA/CBUA/CBTA	5		<b>ZSE 033</b> <sup>202</sup>
---------	-----	-----	-------------	----------------	---	--	-------------------------------

2.5 FSI	2.5	125	07.08-10.10	CCCA/CBUA/CBTA	5		<b>ZSE 142</b> <sup>202</sup>
---------	-----	-----	-------------	----------------	---	--	-------------------------------

**JETTA IV**

1.2 TSI	1.2	77	02.11-	CBZB	4		<b>ZSE 003</b>
---------	-----	----	--------	------	---	--	----------------

1.4 TSI	1.4	90	05.11-	CAXA	4		<b>ZSE 030</b>
---------	-----	----	--------	------	---	--	----------------

1.4 TSI	1.4	118	04.11-	CAVD/CTHD	4		<b>ZSE 030</b>
---------	-----	-----	--------	-----------	---	--	----------------

1,4 TSI Hybrid	1,4	110	04.11-	CNLA	4		<b>ZSE 067</b> <sup>202</sup>
----------------	-----	-----	--------	------	---	--	-------------------------------

1,4 TSI Hybrid	1,4	110	04.11-	CNLA	4		<b>ZSE 126</b> <sup>202</sup>
----------------	-----	-----	--------	------	---	--	-------------------------------

2.0 TSI	2.0	147	12.10-	CBFA/CCZA/CCTA	4		<b>ZSE 033</b> <sup>202</sup>
---------	-----	-----	--------	----------------	---	--	-------------------------------

2.0 TSI	2.0	147	12.10-	CBFA/CCZA/CCTA	4		<b>ZSE 142</b> <sup>202</sup>
---------	-----	-----	--------	----------------	---	--	-------------------------------

2.0 TSI	2.0	155	12.12-	CPPA/CPLA	4		<b>ZSE 068</b>
---------	-----	-----	--------	-----------	---	--	----------------

**KAEFER**

1200 1.2	1.2	25	08.69-12.85	D	4		<b>ZS 106</b>
----------	-----	----	-------------	---	---	--	---------------

1600	1.6	34	05.73-09.92	AF	4		<b>ZS 106</b>
------	-----	----	-------------	----	---	--	---------------

1600 i	1.6	34	10.92-07.03	ACD	4		<b>ZSE 001</b>
--------	-----	----	-------------	-----	---	--	----------------

**LUPO**

1.0	1.0	37	10.98-05.00	AHT	4		<b>ZSE 040</b>
-----	-----	----	-------------	-----	---	--	----------------

1.0	1.0	37	09.98-07.05	AER, ALL	4		<b>ZSE 001</b> <sup>202</sup>
-----	-----	----	-------------	----------	---	--	-------------------------------

1.0	1.0	37	09.98-07.05	ALD, AUC, ANV	4		<b>ZSE 003</b> <sup>202</sup>
-----	-----	----	-------------	---------------	---	--	-------------------------------

1.0	1.0	37	09.98-07.05	AER/ALD/ANV/ALL/AUC	4		<b>ZSE 040</b> <sup>202</sup>
-----	-----	----	-------------	---------------------	---	--	-------------------------------

1.4	1.4	44	10.00-07.05	AUD	4		<b>ZSE 003</b>
-----	-----	----	-------------	-----	---	--	----------------

1.4 16V	1.4	55	09.98-07.05	AHW/APE/AKQ/AUA	4		<b>ZSE 003</b>
---------	-----	----	-------------	-----------------	---	--	----------------

1.4 16V	1.4	55	09.98-07.05	BBY	4		<b>ZSE 030</b>
---------	-----	----	-------------	-----	---	--	----------------

1.4 16V	1.4	74	08.99-07.05	AFK, AQQ, AUB, ANM	4		<b>ZSE 003</b>
---------	-----	----	-------------	--------------------	---	--	----------------

1.6 GTI	1.6	92	09.00-07.05	AVY	4		<b>ZSE 003</b>
---------	-----	----	-------------	-----	---	--	----------------

**NEW BEETLE (9C1, 1C1)**

1.4	1.4	55	11.01-	BCA	4		<b>ZSE 030</b>
-----	-----	----	--------	-----	---	--	----------------

1.6	1.6	74	10.99-09.00	AWH	4		<b>ZSE 003</b>
-----	-----	----	-------------	-----	---	--	----------------

1.6	1.6	75	06.00-	AYD/BFS	4		<b>ZSE 003</b>
-----	-----	----	--------	---------	---	--	----------------

1.8 T	1.8	110	10.99-	AGU	4	<b>ZM 062</b>	
-------	-----	-----	--------	-----	---	---------------	--

1.8 T	1.8	110	10.99-	APH	4		<b>ZSE 009</b>
-------	-----	-----	--------	-----	---	--	----------------

1.8 T	1.8	110	10.99-	AVC, AWU, AWV	4		<b>ZSE 043</b>
-------	-----	-----	--------	---------------	---	--	----------------

2.0	2.0	85	01.98-	APK/AZJ/AVH/AQY/AEG/BEV/BHP/BER/AZG/CBPA/BEJ	4		<b>ZSE 003</b>
-----	-----	----	--------	--	---	--	----------------

2.0	2.0	85	01.98-	AZG, AVH	4		<b>ZSE 029</b>
-----	-----	----	--------	----------	---	--	----------------

2.3 V5	2.3	125	10.00-	AQN	5		<b>ZSE 063</b>
--------	-----	-----	--------	-----	---	--	----------------

2.5	2.5	110	07.05-	BPS/BPR	5		<b>ZSE 142</b>
-----	-----	-----	--------	---------	---	--	----------------

RSI 3.2 4motion	3.2	165	04.00-05.01	AXJ	6		<b>ZSE 013</b>
-----------------	-----	-----	-------------	-----	---	--	----------------

**NEW BEETLE Cabriolet (1Y7)**

1.4	1.4	55	01.03-09.10	BCA	4		<b>ZSE 030</b>
-----	-----	----	-------------	-----	---	--	----------------

1.6	1.6	75	01.03-09.10	BFS	4		<b>ZSE 003</b>
-----	-----	----	-------------	-----	---	--	----------------

1.8 T	1.8	110	01.03-09.10	AWW/AWU/BKF Fgst.Nr.→1C-Y-499 000, 9C-Y-699 000	4		<b>ZSE 009</b>
-------	-----	-----	-------------	--	---	--	----------------

1.8 T	1.8	110	01.03-09.10	AWW/AWU/BKF	4		<b>ZSE 043</b>
-------	-----	-----	-------------	-------------	---	--	----------------

2.0	2.0	85	09.02-10.10	AZJ/BEV/BDC/BGD	4		<b>ZSE 003</b>
-----	-----	----	-------------	-----------------	---	--	----------------

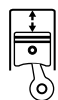

kW

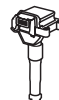
**VW AG****NEW BEETLE Cabriolet (1Y7)**

2.0	2.0	85	09.02–10.10	BEJ, BHP	4		<b>ZSE 029</b>
2.5	2.5	110	07.05–09.10	BPS/BPR	5		<b>ZSE 142</b>

**PARATI**

1.8	1.8	73	08.02–	UDH	4		<b>ZS 314</b>
1.8 Hybrid	1.8	70	08.87–07.94	JH	4		<b>ZS 124</b>

**PASSAT (32B)**

1.3	1.3	44	08.80–07.86	FZ	4	<b>ZM 002</b>	
1.3	1.3	44	08.80–07.86	EP	4		<b>ZS 124</b>
1.3	1.3	44	08.80–07.86	EP/EU	4		<b>ZS 124</b>
1.6	1.6	51	08.87–03.88	PP	4	<b>ZM 012</b>	<b>ZS 124</b>
1.6	1.6	53	08.87–03.88	RL	4	<b>ZM 012</b>	<b>ZS 124</b>
1.6	1.6	53	02.86–07.87	RL	4	<b>ZM 002</b>	<b>ZS 124</b>
1.6	1.6	55	08.80–07.87	WV/YN	4	<b>ZM 002</b>	
1.6	1.6	55	08.87–03.88	WV/YN	4	<b>ZM 012</b>	
1.6	1.6	55	08.84–03.88	DT	4		<b>ZS 124</b>
1.8	1.8	64	05.86–07.87	RM	4	<b>ZM 002</b>	<b>ZS 124</b>
1.8	1.8	64	08.87–03.88	RM	4	<b>ZM 012</b>	<b>ZS 123</b>
1.8	1.8	66	01.83–07.87	DS/JN/JV	4	<b>ZM 002</b>	
1.8	1.8	66	08.87–03.88	DS/JN/JV	4	<b>ZM 012</b>	
1.8	1.8	66	08.84–03.88	DS/JN/JV	4		<b>ZS 124</b>
1.8	1.8	82	12.83–07.87	DZ	4	<b>ZM 002</b>	
1.8	1.8	82	08.87–03.88	DZ	4	<b>ZM 012</b>	
2.0	2.0	85	08.83–07.87	JS/HP	5	<b>ZM 002</b>	
2.0	2.0	85	08.87–03.88	JS/HP	5	<b>ZM 012</b>	
2.0	2.0	85	08.84–03.88	JS/HP	5		<b>ZS 124</b>
2.2	2.2	85	08.85–07.87	KX	5	<b>ZM 002</b>	<b>ZS 124</b>
2.2	2.2	85	08.87–03.88	KX	5	<b>ZM 012</b>	<b>ZS 124</b>
2.2	2.2	100	01.85–07.87	KV	5	<b>ZM 002</b>	<b>ZS 124</b>
2.2	2.2	100	08.87–03.88	KV	5	<b>ZM 012</b>	<b>ZS 124</b>

**PASSAT (3A2, 35I)**

1.6	1.6	53	02.88–09.91	EZ /1F	4	<b>ZM 012</b>	<b>ZS 124</b>
1.6	1.6	53	02.91–09.91	EZ /1F	4	<b>ZM 014</b>	
1.6	1.6	55	02.88–12.88	ABN/EZ	4	<b>ZM 012</b>	<b>ZS 123</b>
1.6	1.6	55	02.88–12.88	ABN/EZ	4	<b>ZM 012</b>	<b>ZS 124</b>
1.6	1.6	74	10.94–08.96	AEK/AFT	4		<b>ZSE 001</b>
1.8	1.8	55	02.91–08.96	AAM	4	<b>ZM 014</b>	<b>ZSE 001</b>
1.8	1.8	66	02.88–07.90	RP/ADZ/ABS	4	<b>ZM 012</b>	
1.8	1.8	66	02.88–08.96	RP	4		<b>ZS 124</b>
1.8	1.8	66	08.91–08.96	ABS	4		<b>ZSE 001</b>
1.8	1.8	66	10.94–08.96	ADZ	4		<b>ZSE 001</b>
1.8	1.8	79	04.88–07.90	PF	4	<b>ZM 012</b>	<b>ZS 124</b>
1.8	1.8	82	04.88–07.89	PB	4		<b>ZS 124</b>
1.8	1.8	82	08.89–07.92	PB	4	<b>ZM 012</b>	<b>ZS 123</b>
1.8 16V	1.8	100	04.88–12.89	KR	4	<b>ZM 012</b>	<b>ZS 123</b>
1.8 G60 Syncro	1.8	118	08.88–08.96	PG	4		<b>ZS 124</b>
2.0	2.0	79	03.95–08.96	AEP	4		<b>ZSE 001</b>
2.0	2.0	85	02.90–08.96	ABA/ADY/2E/AGG	4	<b>ZM 013</b>	<b>ZSE 001</b>
2.0	2.0	85	02.90–08.96	ABA/ADY/2E/AGG	4	<b>ZM 013</b>	<b>ZSE 002</b>
2.0 Syncro	2.0	85	10.90–08.96	2E	4		<b>ZSE 001</b>
2.0 Syncro	2.0	85	10.90–08.96	2E	4		<b>ZSE 002</b>
2.8 VR6	2.8	128	06.91–08.96	AAA Fgst.Nr.31-P-136 399→	6		<b>ZSE 004</b>

**PASSAT (3B2)**

1.6	1.6	74	10.96–11.00	AHL,ANA,ARM	4		<b>ZSE 003</b>
1.6	1.6	74	10.96–11.00	ADP	4		<b>ZSE 006</b>
1.8	1.8	92	10.96–11.00	ADR/APT/ARG	4		<b>ZSE 001</b>
1.8 T	1.8	110	05.97–11.00	AEB, ANB, APU	4	<b>ZM 028</b>	<b>ZS 016</b>
1.8 T	1.8	110	05.97–11.00	AEB, ANB, APU	4	<b>ZM 062</b>	<b>ZS 016</b>
2.3 VR5	2.3	110	10.96–11.00	AGZ	5		<b>ZS 037</b>
2.3 VR5 Syncro/4motion	2.3	110	10.97–11.00	AGZ	5		<b>ZS 037</b>



kW

**VW AG**
**PASSAT (3B3)**

1.6	1.6	75	11.00-05.05	ALZ	4	<b>ZSE 003</b>
1.8 T	1.8	125	02.01-05.05	AWM	4	<b>ZSE 043</b>
1.8 T 20V	1.8	110	11.00-05.05	AWT/AWL	4	<b>ZSE 043</b>
2.0	2.0	85	11.00-05.05	AZM	4	<b>ZSE 003</b>
2.0	2.0	96	11.01-05.05	ALT	4	<b>ZSE 043</b>
2.0 4motion	2.0	85	11.00-05.05	AZM	4	<b>ZSE 003</b>
2.3 V5	2.3	125	11.00-05.05	AZX	5	<b>ZSE 065</b>
2.3 V5 4motion	2.3	125	11.00-05.05	AZX	5	<b>ZSE 065</b>
4.0 W8 4motion	4.0	202	09.01-05.05	BDP/BDN Fgst.Nr.F3B-5000 001→	8	<b>ZSE 031</b>

**PASSAT (3C2)**

1.4 TSI	1.4	90	05.07-07.10	CAXA Fgst.Nr.3C-8-200 001→	4	<b>ZSE 030</b>
1.4 TSI EcoFuel	1.4	110	01.09-07.10	CDGA	4	<b>ZSE 030</b>
1.6	1.6	75	05.05-07.10	BSF/BSE	4	<b>ZSE 003</b>
1.6 FSI	1.6	85	03.05-06.08	BLF Fgst.Nr.→3C-8-200 000	4	<b>ZSE 030</b>
1.8 TSI	1.8	112	11.09-07.10	CDAB/CGYA	4	<b>ZSE 142</b>
1.8 TSI	1.8	118	05.07-07.10	BZB/CDA	4	<b>ZSE 033</b> <sup>202</sup>
1.8 TSI	1.8	118	05.07-07.10	BZB/CDA	4	<b>ZSE 142</b> <sup>202</sup>
2.0 FSI	2.0	110	03.05-07.10	BLY/BLR/BVZ/BVY	4	<b>ZSE 033</b> <sup>202</sup>
2.0 FSI	2.0	110	03.05-07.10	BLY/BLR/BVZ/BVY	4	<b>ZSE 142</b> <sup>202</sup>
2.0 FSI	2.0	125	08.07-07.10	CCTB	4	<b>ZSE 142</b>
2.0 FSI	2.0	147	07.05-07.10	BWA/BPY/AXX/CBFA/CCZA/CAWB/CCTA	4	<b>ZSE 142</b> <sup>202</sup>
2.0 FSI	2.0	147	07.05-07.10	BWA/BPY/AXX/CBFA/CCZA/CAWB/CCTA	4	<b>ZSE 033</b> <sup>202</sup>
2.0 FSI 4motion	2.0	110	09.05-07.10	BVX/BLX/BLY	4	<b>ZSE 033</b> <sup>202</sup>
2.0 FSI 4motion	2.0	110	09.05-07.10	BVX/BLX/BLY	4	<b>ZSE 142</b> <sup>202</sup>
3.2 FSI 4motion	3.2	184	11.05-07.10	AXZ	6	<b>ZSE 041</b>
3.2 FSI 4motion	3.2	184	11.05-07.10	AXZ	6	<b>ZSE 044</b>
3.6 FSI	3.6	206	06.05-07.10	BLV	6	<b>ZSE 041</b>
3.6 FSI 4motion	3.6	206	09.05-07.10	BLV	6	<b>ZSE 041</b>
3.6 R36 4motion	3.6	220	04.07-07.10	BWS	6	<b>ZSE 041</b>
3.6 R36 4motion	3.6	220	04.07-07.10	BWS	6	<b>ZSE 044</b>

**PASSAT (362)**

1.4 TSI	1.4	90	08.10-	CAXA	4	<b>ZSE 030</b>
1.4 TSI EcoFuel	1.4	110	08.10-	CDGA	4	<b>ZSE 040</b>
1.8 TSI	1.8	112	02.11-	CDAB	4	<b>ZSE 142</b>
1.8 TSI	1.8	118	08.10-	CDA	4	<b>ZSE 033</b> <sup>202</sup>
1.8 TSI	1.8	118	08.10-	CDA	4	<b>ZSE 142</b> <sup>202</sup>
2.0 TSI	2.0	155	11.10-	CCZB	4	<b>ZSE 033</b> <sup>202</sup>
2.0 TSI	2.0	155	11.10-	CCZB	4	<b>ZSE 142</b> <sup>202</sup>
3.6 FSI 4motion	3.6	220	01.11-	BWS	6	<b>ZSE 041</b>
3.6 FSI 4motion	3.6	220	01.11-	BWS	6	<b>ZSE 044</b>

**PASSAT ALLTRACK (365)**

2.0 TSI 4motion	2.0	155	01.12-	CCZB	4	<b>ZSE 033</b>
-----------------	-----	-----	--------	------	---	----------------

**PASSAT CC (357)**

1.8 TSI	1.8	112	11.08-05.10	CDAB/CGYA	4	<b>ZSE 142</b>
1.8 TSI	1.8	118	06.08-11.10	BZB/CDA	4	<b>ZSE 033</b>
1.8 TSI	1.8	118	06.08-11.10	BZB/CDA	4	<b>ZSE 142</b> <sup>202</sup>
2.0 TSI	2.0	147	06.08-	CBFA/CCZA/CAWB/CCTA	4	<b>ZSE 033</b> <sup>202</sup>
2.0 TSI	2.0	147	06.08-	CBFA/CCZA/CAWB/CCTA	4	<b>ZSE 142</b> <sup>202</sup>
2.0 TSI	2.0	155	11.10-	CCZB	4	<b>ZSE 033</b> <sup>202</sup>
2.0 TSI	2.0	155	11.10-	CCZB	4	<b>ZSE 142</b> <sup>202</sup>
3.6 FSI 4motion	3.6	220	06.08-05.10	BWS	6	<b>ZSE 041</b> <sup>202</sup>
3.6 FSI 4motion	3.6	220	06.08-05.10	BWS	6	<b>ZSE 044</b> <sup>202</sup>

**PASSAT Variant (32B)**

1.3	1.3	44	08.80-07.86	FZ	4	<b>ZM 002</b>
1.3	1.3	44	08.80-07.86	EP	4	<b>ZS 124</b>
1.6	1.6	51	08.87-03.88	PP	4	<b>ZM 002</b> <b>ZS 124</b>
1.6	1.6	51	08.87-03.88	PP	4	<b>ZM 012</b> <b>ZS 124</b>
1.6	1.6	55	08.80-07.87	WV/YN	4	<b>ZM 002</b>
1.6	1.6	55	08.87-03.88	WV/YN	4	<b>ZM 012</b>





kW

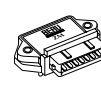
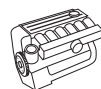

## VW AG

## PASSAT Variant (32B)

1.6	1.6	53	08.87-03.88	RL	4	ZM 012	ZS 124	
1.6	1.6	53	02.86-07.87	RL	4	ZM 002	ZS 124	
1.6	1.6	55	08.84-03.88	DT	4		ZS 124	
1.8	1.8	64	05.86-07.87	RM	4	ZM 002	ZS 124	
1.8	1.8	64	08.87-03.88	RM	4	ZM 012	ZS 123	
1.8	1.8	66	01.83-07.87	DS/JN/JV	4	ZM 002		
1.8	1.8	66	08.87-03.88	DS/JN/JV	4	ZM 012		
1.8	1.8	66	08.84-03.88	DS/JN/JV	4		ZS 124	
1.8	1.8	82	12.83-07.87	DZ	4	ZM 002		
1.8	1.8	82	08.87-03.88	DZ	4	ZM 012		
1.8 Syncro	1.8	66	01.86-07.87	DS/JN	4	ZM 002	ZS 124	
1.8 Syncro	1.8	66	08.87-03.88	DS/JN	4	ZM 012	ZS 124	
2.0	2.0	85	08.83-07.87	JS/HP	5	ZM 002	ZS 124	
2.0	2.0	85	08.87-03.88	JS/HP	5	ZM 012	ZS 124	
2.0 Syncro	2.0	85	05.84-07.87	JS	5	ZM 002	ZS 124	
2.0 Syncro	2.0	85	08.87-03.88	JS	5	ZM 012	ZS 124	
2.2	2.2	85	08.85-07.87	KX	5	ZM 002	ZS 124	
2.2	2.2	85	08.87-03.88	KX	5	ZM 012	ZS 124	
2.2	2.2	100	01.85-07.87	KV	5	ZM 002	ZS 124	
2.2	2.2	100	08.87-03.88	KV	5	ZM 012	ZS 124	
2.2 Syncro	2.2	88	08.85-07.87	JT	5	ZM 002	ZS 124	
2.2 Syncro	2.2	88	08.87-03.88	JT	5	ZM 012	ZS 124	
2.2 Syncro	2.2	88	08.85-03.88	JT	5		ZS 124	

## PASSAT Variant (3A5, 35I)

1.6	1.6	53	04.88-02.91	EZ /1F	4	ZM 012		
1.6	1.6	53	02.91-09.91	EZ /1F	4	ZM 014		
1.6	1.6	53	04.88-09.91	1F	4		ZS 124	
1.6	1.6	55	04.88-12.88	EZ	4	ZM 012	ZS 123 <sup>202</sup>	
				Fgst.Nr.→31..K..400000				
1.6	1.6	55	04.88-12.88	EZ	4		ZS 124 <sup>202</sup>	
1.6	1.6	74	10.94-12.95	AEK/AFT	4		ZSE 001	
1.8	1.8	55	08.90-05.97	AAM	4	ZM 014	ZSE 001	
1.8	1.8	66	02.88-05.97	RP	4		ZS 124	
1.8	1.8	66	08.91-05.97	ABS	4		ZSE 001	
1.8	1.8	66	10.94-05.97	ADZ	4		ZSE 001	
1.8	1.8	66	02.88-07.90	RP/ADZ/ABS	4	ZM 012		
1.8	1.8	79	04.88-07.90	PF	4	ZM 012	ZS 124	
1.8	1.8	82	04.88-07.89	PB	4	ZM 012	ZS 124	
1.8	1.8	82	08.89-07.92	PB	4	ZM 012	ZS 123	
1.8 16V	1.8	100	04.88-07.89	KR	4	ZM 012	ZS 123	
1.8 16V	1.8	100	08.89-12.89	KR	4	ZM 012	ZS 124	
1.8 G60 Syncro	1.8	118	08.88-05.97	PG	4		ZS 124	
2.0	2.0	79	03.95-08.96	AEP	4		ZSE 001	
2.0	2.0	85	02.90-05.97	ADY/2E/AGG	4	ZM 002		
2.0	2.0	85	02.90-05.97	2E	4		ZSE 001	
2.0	2.0	85	02.90-05.97	2E	4		ZSE 002	
2.0 16V	2.0	110	01.94-05.97	ABF	4	ZM 002	ZSE 001	
2.0 Syncro	2.0	85	10.90-05.97	2E	4		ZSE 001	
2.0 Syncro	2.0	85	10.90-05.97	2E	4		ZSE 002	
2.8 VR6	2.8	128	06.91-05.97	AAA	6		ZSE 004	
				Fgst.Nr.31-P-136 399→				
2.9 VR6 Syncro	2.9	135	01.94-05.97	ABV	6		ZSE 004	

## PASSAT Variant (3B5)

1.6	1.6	74	06.97-11.00	AHL,ANA,ARM	4		ZSE 003	
1.6	1.6	74	06.97-11.00	ADP	4		ZSE 006	
1.8 T	1.8	110	06.97-11.00	AEB, ANB, APU	4	ZM 028	ZS 016	
1.8 T	1.8	110	06.97-11.00	AEB, ANB, APU	4	ZM 062	ZS 016	
2.3 VR5	2.3	110	06.97-11.00	AGZ	5		ZS 037	
2.3 VR5 Syncro/4motion	2.3	110	10.97-11.00	AGZ	5		ZS 037	

## PASSAT Variant (3B6)

1.6	1.6	75	11.00-05.05	ALZ	4		ZSE 003	
-----	-----	----	-------------	-----	---	--	---------	--



kW

**VW AG**
**PASSAT Variant (386)**

1.8 T	1.8	125	05.02–08.05	AWM	4	<b>ZSE 043</b>
1.8 T 20V	1.8	110	11.00–05.05	AWT	4	<b>ZSE 043</b>
2.0	2.0	85	11.00–05.05	AZM	4	<b>ZSE 003</b>
2.0	2.0	96	11.01–05.05	ALT	4	<b>ZSE 043</b>
2.0 4motion	2.0	85	11.00–05.05	AZM	4	<b>ZSE 003</b>
2.3 VR5	2.3	125	11.00–05.05	AZX	5	<b>ZSE 065</b>
2.3 VR5 4motion	2.3	125	11.00–05.05	AZX	5	<b>ZSE 065</b>
4.0 W8 4motion	4.0	202	09.01–05.05	BDP/BDN Fgst.Nr.F3B-5000 001→	8	<b>ZSE 031</b>

**PASSAT Variant (3C5)**

1.4 TSI	1.4	90	05.07–11.10	CAXA Fgst.Nr.→F1K-8-281 299	4	<b>ZSE 030</b>
1.4 TSI EcoFuel	1.4	110	01.09–11.10	CDGA	4	<b>ZSE 030</b>
1.6	1.6	75	08.05–11.10	BSF/BSE	4	<b>ZSE 003</b>
1.6 FSI	1.6	85	08.05–06.08	BLF Fgst.Nr.→3C-8-200 000	4	<b>ZSE 030</b>
1.8 TSI	1.8	112	11.09–11.10	CDAB/CGYA	4	<b>ZSE 142</b>
1.8 TSI	1.8	118	05.07–10.11	BZB/CDAA	4	<b>ZSE 033</b> <sup>202</sup>
1.8 TSI	1.8	118	05.07–10.11	BZB/CDAA	4	<b>ZSE 142</b> <sup>202</sup>
2.0 FSI	2.0	110	08.05–11.10	BLY/BLR/BVZ/BVY	4	<b>ZSE 033</b> <sup>202</sup>
2.0 FSI	2.0	110	08.05–11.10	BLY/BLR/BVZ/BVY	4	<b>ZSE 142</b> <sup>202</sup>
2.0 FSI	2.0	125	08.07–11.10	CCTB	4	<b>ZSE 142</b>
2.0 FSI	2.0	147	08.05–11.10	BWA/BPY/AXX/CBFA/CCZA/CAWB/CCTA	4	<b>ZSE 033</b> <sup>202</sup>
2.0 FSI	2.0	147	08.05–11.10	BWA/BPY/AXX/CBFA/CCZA/CAWB/CCTA	4	<b>ZSE 142</b> <sup>202</sup>
2.0 FSI 4motion	2.0	110	09.05–11.10	BVX/BLX/BLY	4	<b>ZSE 033</b> <sup>202</sup>
2.0 FSI 4motion	2.0	110	09.05–11.10	BVX/BLX/BLY	4	<b>ZSE 142</b> <sup>202</sup>
3.2 FSI 4motion	3.2	184	11.05–11.10	AXZ	6	<b>ZSE 041</b>
3.2 FSI 4motion	3.2	184	11.05–11.10	AXZ	6	<b>ZSE 044</b>
3.6 FSI	3.6	206	09.05–11.10	BLV	6	<b>ZSE 041</b>
3.6 FSI 4motion	3.6	206	09.05–11.10	BLV	6	<b>ZSE 041</b>
3.6 R36 4motion	3.6	220	04.07–11.10	BWS	6	<b>ZSE 044</b>

**PASSAT Variant (365)**

1.4 TSI	1.4	90	08.10–	CAXA	4	<b>ZSE 030</b>
1.4 TSI EcoFuel	1.4	110	08.10–	CDGA	4	<b>ZSE 030</b>
1.8 TSI	1.8	112	02.11–	CDAB	4	<b>ZSE 142</b>
1.8 TSI	1.8	118	08.10–	CDAA	4	<b>ZSE 033</b> <sup>202</sup>
1.8 TSI	1.8	118	08.10–	CDAA	4	<b>ZSE 142</b> <sup>202</sup>
2.0 TSI	2.0	155	11.10–	CCZB	4	<b>ZSE 033</b> <sup>202</sup>
2.0 TSI	2.0	155	11.10–	CCZB	4	<b>ZSE 142</b> <sup>202</sup>
3.6 FSI 4motion	3.6	220	01.11–	BWS	6	<b>ZSE 041</b>
3.6 FSI 4motion	3.6	220	01.11–	BWS	6	<b>ZSE 044</b>

**PHAETON**

3.2 V6	3.2	177	04.02–	AYT/BKL	6	<b>ZSE 044</b>
3.2 V6 4motion	3.2	177	02.04–	BRK/BKL	6	<b>ZSE 044</b>
4.2 V8 4motion	4.2	246	05.03–	BGJ/BGH	8	<b>ZSE 062</b>
6.0 W12 4motion	6.0	309	04.02–	BAN Fgst.Nr.F3D-4-030-001→	12	<b>ZSE 031</b>
6.0 W12 4motion	6.0	331	05.05–	BTT/BRN	12	<b>ZSE 031</b>

**POINTER**

1.8	1.8	73	06.02–07.05	UDH	4	<b>ZS 314</b>
1.8	1.8	73	08.05–	UDH	4	<b>ZS 314</b>
1.8 Hybrid	1.8	73	08.05–	UDH	4	<b>ZS 314</b>

**POLO (6N1)**

45 1.0	1.0	33	10.94–09.96	AEV	4	<b>ZSE 001</b>
50 1.0	1.0	37	09.96–10.99	AER/ALL	4	<b>ZSE 001</b>
55 1.3	1.3	40	10.94–07.95	ADX	4	<b>ZSE 001</b>
55 1.4	1.4	40	08.95–10.99	AEX	4	<b>ZSE 001</b>
60 1.4	1.4	44	07.95–10.99	AEX/AKV/APQ	4	<b>ZSE 001</b>
75 1.6	1.6	55	10.94–10.99	AEA/AEE/AHS	4	<b>ZSE 001</b>
100 1.4 16V	1.4	74	04.96–10.99	AFH	4	<b>ZSE 001</b>
120 1.6 16V GTI	1.6	88	09.98–10.99	AJV	4	<b>ZSE 003</b>



kW



## VW AG

## POLO (6N2)

1.0	1.0	37	10.99-09.01	AUC, ALD	4	ZSE 003
1.4	1.4	40	10.99-09.01	ANX/AKP	4	ZSE 003
1.4	1.4	44	10.99-09.01	AKK, AUD	4	ZSE 003
1.4 16V	1.4	55	10.99-09.01	AHW, AUA	4	ZSE 003
1.4 16V	1.4	74	10.99-09.01	AFK, AUB	4	ZSE 003
1.6 16V GTI	1.6	92	10.99-09.01	ARC, AVY	4	ZSE 003

## POLO (6R\_)

1.2	1.2	44	06.09-	CGPB Fgst.Nr.6R-A-000 001→	3	ZSE 030
1.2	1.2	51	06.09-	CGPA Fgst.Nr.6R-A-000 001→	3	ZSE 030
1.2 TSI	1.2	77	11.09-	CBZB	4	ZSE 003
1.4	1.4	63	06.09-	CGGB, CLPA, CDDA	4	ZSE 030
1.4 GTI	1.4	132	05.10-	CAVE/CTHE	4	ZSE 030
1.4 TSI	1.4	103	10.12-	CPTA	4	ZSE 067 <sup>202</sup>
1.4 TSI	1.4	103	10.12-	CPTA	4	ZSE 126 <sup>202</sup>

## POLO (86C, 80)

1.0	1.0	29	08.85-09.86	GL	4	ZM 002
1.0	1.0	29	09.86-10.86	GL	4	ZM 012
1.0	1.0	33	08.85-09.86	HZ	4	ZM 002
1.0	1.0	33	09.86-09.90	HZ	4	ZM 012
1.0	1.0	33	10.90-01.92	HZ	4	ZM 014 ZSE 001
1.0	1.0	33	08.87-07.89	HZ	4	ZS 123
1.0	1.0	33	08.89-09.90	HZ	4	ZS 124
1.0	1.0	33	10.90-01.92	HZ	4	ZSE 002
1.0 KAT	1.0	33	08.89-09.94	AAK	4	ZS 124
1.0 KAT	1.0	33	08.89-09.94	AAU/AAK/ACM	4	ZM 012 ZSE 001
1.0 KAT	1.0	33	08.89-09.94	AAU/AAK/ACM	4	ZM 012 ZSE 002
1.1	1.1	37	10.81-09.89	HB	4	ZM 002 ZS 115
1.3	1.3	40	08.85-09.86	MH/HK	4	ZM 002
1.3	1.3	40	09.86-07.88	MH/HK	4	ZM 012
1.3	1.3	40	08.83-07.88	HK	4	ZS 115
1.3	1.3	40	08.83-07.88	MH	4	ZS 123
1.3	1.3	55	08.85-09.86	GK	4	ZM 002
1.3	1.3	55	09.86-09.89	GK	4	ZM 012
1.3	1.3	55	09.82-09.89	GK	4	ZS 123
1.3 KAT	1.3	40	07.87-07.89	MH, NZ, 2G	4	ZM 012 ZS 123
1.3 KAT	1.3	40	10.90-09.94	NZ, 2G	4	ZM 014
1.3 KAT	1.3	40	08.89-09.90	NZ, 2G	4	ZS 124
1.3 KAT	1.3	40	10.90-09.94	NZ, 2G, AAV	4	ZSE 001
1.3 KAT	1.3	40	10.90-09.94	NZ, 2G	4	ZSE 002
1.3 KAT	1.3	55	10.89-03.91	3F	4	ZS 124
1.3 KAT	1.3	55	10.89-03.91	3F	4	ZSE 001
1.3 KAT	1.3	55	10.89-09.90	3F	4	ZM 012

## POLO (9N\_)

1.2	1.2	40	05.04-05.07	AWY, BMD Fgst.Nr.→9N-5-260 000	3	ZSE 059
1.2	1.2	44	05.07-11.09	BBM	3	ZSE 059
1.2 12V	1.2	47	10.01-07.07	AZQ, BME	3	ZSE 030
1.2 12V	1.2	51	05.07-11.09	BZG	3	ZSE 030
1.4 16V	1.4	55	10.01-05.08	AUA	4	ZSE 003
1.4 16V	1.4	55	10.01-05.08	BBY	4	ZSE 030
1.4 16V	1.4	59	05.06-11.09	BUD Fgst.Nr.→F1K-8-281 299	4	ZSE 030
1.4 16V	1.4	74	10.01-05.08	AUB, BBZ	4	ZSE 030
1.4 FSI	1.4	63	02.02-07.06	AXU	4	ZSE 030
1.6 16V	1.6	77	05.06-11.09	BTS	4	ZSE 030
1.6 Total Flex	1.6	74	06.08-04.09	CCRA	4	ZSE 003
1.8 GTI	1.8	110	09.05-11.09	BJX	4	ZSE 043
1.8 GTI Cup Edition	1.8	132	05.06-11.09	BBU	4	ZSE 043

## POLO CLASSIC (6KV2)

60 1.4	1.4	44	12.95-09.01	AEX, AKV, ANX, APQ	4	ZSE 001
--------	-----	----	-------------	--------------------	---	---------



kW

**VW AG**
**POLO CLASSIC (6KV2)**

60 1.4	1.4	44	12.95-09.01	AKK, AUD, ANW	4	<b>ZSE 003</b>
75 1.4 16V	1.4	55	10.99-09.01	APE/AUA	4	<b>ZSE 003</b>
75 1.6	1.6	55	11.95-09.97	1F	4	<b>ZSE 001</b>
75 1.6	1.6	55	11.95-09.01	AEE	4	<b>ZSE 001</b>
100 1.6	1.6	74	12.95-09.01	AKL/APF/AEH/AUR/AFT	4	<b>ZSE 001</b>

**POLO CLASSIC (86C, 80)**

1.0	1.0	29	08.85-09.86	GL	4	<b>ZM 002</b>
1.0	1.0	29	09.86-10.86	GL	4	<b>ZM 012</b>
1.0	1.0	33	08.85-09.86	AAU/HZ/AAK	4	<b>ZM 002</b>
1.0	1.0	33	09.86-09.94	AAU/HZ/AAK	4	<b>ZM 012</b>
1.0	1.0	33	08.87-07.89	HZ	4	<b>ZS 123</b>
1.0	1.0	33	08.89-09.90	HZ	4	<b>ZS 124</b>
1.0	1.0	33	10.90-09.94	AAU	4	<b>ZSE 001</b>
1.0	1.0	33	10.90-09.94	HZ	4	<b>ZSE 002</b>
1.3	1.3	40	08.85-09.86	MH/HK	4	<b>ZM 002</b>
1.3	1.3	40	09.86-07.87	MH/HK	4	<b>ZM 012</b>
1.3	1.3	40	01.85-07.87	HK	4	<b>ZS 115</b>
1.3	1.3	40	01.85-07.87	MH	4	<b>ZS 123</b>
1.3 KAT	1.3	40	07.87-07.89	NZ/MH	4	<b>ZS 123</b>
1.3 KAT	1.3	40	08.89-09.90	NZ	4	<b>ZS 124</b>
1.3 KAT	1.3	40	07.87-09.94	NZ/MH	4	<b>ZM 012</b>
1.3 KAT	1.3	40	10.90-09.94	NZ	4	<b>ZSE 001</b>
1.3 KAT	1.3	40	10.90-09.94	NZ	4	<b>ZSE 002</b>

**POLO Coupe (86C, 80)**

1.0	1.0	29	08.85-10.86	GL	4	<b>ZM 002</b>
1.0	1.0	29	09.86-10.86	GL	4	<b>ZM 012</b>
1.0	1.0	33	08.85-09.86	HZ	4	<b>ZM 002</b>
1.0	1.0	33	09.86-09.90	HZ	4	<b>ZM 012</b>
1.0	1.0	33	08.87-07.89	HZ	4	<b>ZS 123</b>
1.0	1.0	33	10.90-01.92	HZ	4	<b>ZM 014</b> <b>ZSE 001</b>
1.0	1.0	33	10.90-01.92	HZ	4	<b>ZM 014</b> <b>ZSE 002</b>
1.0	1.0	33	08.89-09.90	HZ	4	<b>ZS 124</b>
1.0 KAT	1.0	33	08.89-09.90	AAU/AAK/ACM	4	<b>ZM 012</b>
1.0 KAT	1.0	33	08.89-09.94	AAK	4	<b>ZS 124</b>
1.0 KAT	1.0	33	08.89-09.94	AAU/ACM	4	<b>ZSE 001</b>
1.0 KAT	1.0	33	08.89-09.94	ACM	4	<b>ZSE 002</b>
1.3	1.3	40	08.85-09.86	MH/HK	4	<b>ZM 002</b>
1.3	1.3	40	09.86-06.87	MH/HK	4	<b>ZM 012</b>
1.3	1.3	40	08.83-06.87	HK	4	<b>ZS 115</b>
1.3	1.3	40	08.83-06.87	MH	4	<b>ZS 123</b>
1.3	1.3	55	08.85-09.86	GK	4	<b>ZM 002</b> <b>ZS 123</b>
1.3	1.3	55	09.86-09.89	GK	4	<b>ZM 012</b> <b>ZS 123</b>
1.3 G40	1.3	83	08.90-09.94	PY	4	<b>ZSE 001</b>
1.3 G40	1.3	85	01.87-08.90	PY	4	<b>ZM 002</b> <b>ZS 124</b>
1.3 KAT	1.3	40	07.87-09.90	NZ/2G/MH/AAV	4	<b>ZM 012</b>
1.3 KAT	1.3	40	10.90-08.94	NZ, 2G	4	<b>ZM 014</b>
1.3 KAT	1.3	40	07.87-07.89	MH, NZ, 2G	4	<b>ZS 123</b>
1.3 KAT	1.3	40	10.90-08.94	NZ, 2G, AAV	4	<b>ZSE 001</b>
1.3 KAT	1.3	40	10.90-08.94	NZ, 2G	4	<b>ZSE 002</b>
1.3 KAT	1.3	40	08.89-09.90	NZ, 2G	4	<b>ZS 124</b>
1.3 KAT	1.3	55	10.89-09.90	3F	4	<b>ZM 012</b>
1.3 KAT	1.3	55	10.89-09.94	3F	4	<b>ZS 124</b>
1.3 KAT	1.3	55	10.90-09.94	3F	4	<b>ZSE 001</b>

**POLO Variant (6KV5)**

1.4	1.4	40	12.98-09.01	AKP	4	<b>ZSE 003</b>
1.4	1.4	44	05.97-09.01	AEX, AKV, ANW, ANX, APQ	4	<b>ZSE 001</b>
1.4	1.4	44	05.97-09.01	AKK	4	<b>ZSE 003</b>
1.4 16V	1.4	55	10.99-09.01	APE, AUA	4	<b>ZSE 003</b>
1.6	1.6	74	05.97-09.01	AFT	4	<b>ZSE 001</b>
1.6	1.6	74	09.99-09.01	APF, AUR, AEH, AKL	4	<b>ZSE 003</b>
1.6	1.6	55	05.97-09.01	ALM/AEE	4	<b>ZSE 001</b>



kW

**VW AG**

<b>VW AG</b>							
<b>SANTANA</b>							
1.6	1.6	55	08.81-12.84	WV	4	ZM 002	ZS 115
1.8	1.8	66	01.83-12.84	DS	4	ZM 002	ZS 124
2.0	2.0	85	08.83-12.84	JS/HP	5	ZM 002	ZS 124
<b>SAVEIRO</b>							
1.6	1.6	74	09.09-	CCRA	4		ZSE 003
1.6 Total Flex	1.6	74	09.09-	CCRA	4		ZSE 003
<b>SCIROCCO (137)</b>							
1.4 TSI	1.4	90	08.08-	CMSB/CAXA	4		ZSE 030
1.4 TSI	1.4	118	05.08-	CTKA/CAVD/CTHD/CNWA	4		ZSE 030
2.0 R	2.0	188	11.09-	CDLC	4		ZSE 033 <sup>202</sup>
2.0 R	2.0	188	11.09-	CDLC	4		ZSE 142 <sup>202</sup>
2.0 R	2.0	195	11.09-	CDLA	4		ZSE 033 <sup>202</sup>
2.0 R	2.0	195	11.09-	CDLA	4		ZSE 142 <sup>202</sup>
2.0 TSI	2.0	147	05.08-11.09	CAWB	4		ZSE 033 <sup>202</sup>
2.0 TSI	2.0	147	05.08-11.09	CAWB	4		ZSE 142 <sup>202</sup>
2.0 TSI	2.0	155	11.09-05.11	CCZB	4		ZSE 033 <sup>202</sup>
2.0 TSI	2.0	155	11.09-05.11	CCZB	4		ZSE 142 <sup>202</sup>
<b>SCIROCCO (53B)</b>							
1.6	1.6	53	04.86-07.90	RE	4	ZM 002	ZS 124
1.6	1.6	55	08.84-12.89	EW	4	ZM 012	ZS 124
1.8	1.8	66	08.83-07.92	EX	4	ZM 002	
1.8	1.8	66	08.83-07.92	EX	4	ZM 012	
1.8	1.8	66	08.84-07.92	EX	4		ZS 124
1.8	1.8	70	11.85-09.86	JH	4	ZM 002	
1.8	1.8	70	10.86-07.92	JH	4	ZM 012	
1.8	1.8	70	11.85-07.92	JH	4		ZS 124
1.8	1.8	82	08.82-09.86	EV/JJ/PB/DX	4	ZM 002	
1.8	1.8	82	10.86-12.89	EV/JJ/PB/DX	4	ZM 012	
1.8	1.8	82	08.84-12.89	EV/JJ/PB/DX	4		ZS 124
1.8 16V	1.8	95	10.86-07.92	PL	4	ZM 012	ZS 124
1.8 16V	1.8	95	03.86-09.86	PL	4	ZM 002	ZS 124
1.8 16V	1.8	102	10.85-09.86	KR	4	ZM 002	ZS 124
1.8 16V	1.8	102	10.86-07.89	KR	4	ZM 012	ZS 124
<b>SHARAN (7M8, 7M9, 7M6)</b>							
1.8 T 20V	1.8	110	09.97-03.10	AJH	4		ZS 016 ZLE 276
1.8 T 20V	1.8	110	04.00-03.10	AWC	4		ZSE 009
2.0	2.0	85	09.95-03.10	ADY	4	ZM 013	ZSE 001
2.0 LPG	2.0	85	04.06-03.10	ATM	4		ZSE 003
2.8 V6 24V	2.8	150	04.00-03.10	AYL	6		ZSE 063
2.8 V6 24V 4motion	2.8	150	04.00-03.10	AYL	6		ZSE 063
2.8 VR6	2.8	128	09.95-12.97	AAA/AMY	6		ZSE 004
2.8 VR6 Syncro	2.8	128	11.96-12.97	AAA/AMY	6		ZSE 004
<b>SHARAN (7N)</b>							
1.4 TSI	1.4	110	05.10-	CTHA/CNWB/CAVA	4		ZSE 030
2.0 TSI	2.0	147	12.10-	CCZA	4		ZSE 033 <sup>202</sup>
2.0 TSI	2.0	147	12.10-	CCZA	4		ZSE 142 <sup>202</sup>
<b>SPACEFOX</b>							
1.6	1.6	74	03.06-	BPA , CCRA , CFZA	4		ZSE 003
1.6 Total Flex	1.6	74	03.06-	BPA , CCRA , CFZA	4		ZSE 003
<b>TIGUAN (5N_)</b>							
1.4 TSI	1.4	90	08.10-	CAXA	4		ZSE 030
1.4 TSI	1.4	110	05.08-	BWK/CTHA/CAVA	4		ZSE 030
1.4 TSI	1.4	118	05.11-	CAVD/CTHD	4		ZSE 030
1.4 TSI 4motion	1.4	110	09.07-	BWK/CTHA/CAVA	4		ZSE 030
1.4 TSI 4motion	1.4	118	05.11-	CAVD/CTHD	4		ZSE 030
2.0 TFSI 4motion	2.0	125	09.07-	CAWA/CCZC	4		ZSE 033 <sup>202</sup>
2.0 TFSI 4motion	2.0	125	09.07-	CAWA/CCZC	4		ZSE 142 <sup>202</sup>
2.0 TFSI 4motion	2.0	147	09.07-	CCZA/CAWB/CCTA	4		ZSE 033 <sup>202</sup>
2.0 TFSI 4motion	2.0	147	09.07-	CCZA/CAWB/CCTA	4		ZSE 142 <sup>202</sup>
2.0 TSI 4motion	2.0	132	05.11-	CCZD	4		ZSE 033
2.0 TSI 4motion	2.0	155	05.11-	CCZB	4		ZSE 033



kW

**VW AG**
**TOUAREG (7LA, 7L6, 7L7)**

3.2 V6	3.2	177	11.04–11.06		6	<b>ZSE 044</b>
3.6 V6 FSI	3.6	206	10.05–05.10	BHL/BHK	6	<b>ZSE 041</b>
4.2 V8	4.2	228	12.02–11.06	AXQ	8	<b>ZSE 062</b>
4.2 V8 FSI	4.2	257	06.06–05.10	BAR	8	<b>ZSE 032</b> <sup>202</sup>
4.2 V8 FSI	4.2	257	06.06–05.10	BAR	8	<b>ZSE 033</b> <sup>202</sup>
4.2 V8 FSI	4.2	257	06.06–05.10	BAR	8	<b>ZSE 142</b> <sup>202</sup>
6.0 W12	6.0	331	08.04–05.10	CFRA/BJN	12	<b>ZSE 031</b>

**TOUAREG (7P5)**

3.0 V6 TSI	3.0	213	08.10–	CJTA	6	<b>ZSE 032</b>
3.6 V6 FSI	3.6	206	04.10–	CGRA	6	<b>ZSE 041</b>

**TOURAN (1T1, 1T2)**

1.4 FSI	1.4	125	11.06–05.10	BLG/CAVB	4	<b>ZSE 030</b>
1.4 TSI	1.4	103	02.06–05.10	BMV/CAVC Fgst.Nr.→F1K-8-281 299	4	<b>ZSE 030</b>
1.4 TSI EcoFuel	1.4	110	05.09–05.10	CDGA	4	<b>ZSE 030</b>
1.6	1.6	75	07.03–05.10	BGU/BSF/BSE	4	<b>ZSE 003</b>
1.6 FSI	1.6	85	02.03–01.07	BLF/BLP/BAG	4	<b>ZSE 030</b>
2.0 EcoFuel	2.0	80	02.06–05.09	BSX	4	<b>ZSE 029</b>
2.0 FSI	2.0	110	10.03–11.05	BLX/BLY/BLR/AXW/BVZ/BVY	4	<b>ZSE 033</b> <sup>202</sup>
2.0 FSI	2.0	110	10.03–11.05	BLX/BLY/BLR/AXW/BVZ/BVY	4	<b>ZSE 142</b> <sup>202</sup>

**TOURAN (1T3)**

1.2 TSI	1.2	77	05.10–	CBZB	4	<b>ZSE 003</b>
1.4 TSI	1.4	103	05.10–	CTHC/CAVC	4	<b>ZSE 030</b>

**UP**

1.0	1.0	44	12.11–	CHYA	3	<b>ZSE 067</b> <sup>202</sup>
1.0	1.0	44	12.11–	CHYA	3	<b>ZSE 126</b> <sup>202</sup>
1.0	1.0	55	12.11–	CHYB	3	<b>ZSE 067</b> <sup>202</sup>
1.0	1.0	55	12.11–	CHYB	3	<b>ZSE 126</b> <sup>202</sup>
1,0 EcoFuel	1,0	50	11.12–	CPGA	3	<b>ZSE 067</b> <sup>202</sup>
1,0 EcoFuel	1,0	50	11.12–	CPGA	3	<b>ZSE 126</b> <sup>202</sup>

**VENTO (1H2)**

1.4	1.4	40	11.91–09.98	AEX/ABD	4	<b>ZM 013</b> <b>ZSE 001</b>
1.4	1.4	44	11.91–09.98	AEX/ABD	4	<b>ZM 013</b> <b>ZSE 001</b>
1.6	1.6	55	09.92–09.98	ABU/AEA/AEE	4	<b>ZSE 002</b>
1.6	1.6	74	10.94–12.95	AEK/AFT	4	<b>ZSE 001</b>
1.8	1.8	55	11.91–09.98	AAM	4	<b>ZM 013</b> <b>ZSE 001</b>
1.8	1.8	66	11.91–09.98	ADZ/ABS	4	<b>ZM 013</b> <b>ZSE 001</b>
2.0	2.0	85	11.91–09.98	ADY/AKR/2E/AGG	4	<b>ZSE 001</b> <sup>202</sup>
2.8 VR6	2.8	128	01.92–09.98	AAA	6	<b>ZSE 004</b>

**VOYAGE**

1.6	1.6	74	10.08–	CCRA	4	<b>ZSE 003</b>
1.6 Flex	1.6	74	07.08–	CFZA	4	<b>ZSE 003</b>

**Bus/Transporter T 3**

1.9	1.9	44	09.84–07.87	DF	4	<b>ZS 124</b>
1.9	1.9	44	08.87–07.92	DF	4	<b>ZS 123</b>
1.9	1.9	44	08.82–07.92	DF	4	<b>ZM 002</b>
1.9	1.9	57	08.87–07.89	DG	4	<b>ZS 123</b>
1.9	1.9	57	08.82–07.92	DG	4	<b>ZM 012</b> <b>ZS 124</b>
1.9	1.9	61	01.83–07.85	DH	4	<b>ZM 002</b>
1.9	1.9	61	09.84–07.85	DH	4	<b>ZS 124</b>
1.9	1.9	66	08.83–07.85	GW	4	<b>ZM 002</b>
1.9	1.9	66	09.84–07.85	GW	4	<b>ZS 124</b>
1.9 Syncro	1.9	57	08.87–07.89	DG	4	<b>ZS 123</b>
1.9 Syncro	1.9	57	02.85–07.92	DG	4	<b>ZM 012</b> <b>ZS 124</b>
2.1	2.1	64	10.86–07.92	SR	4	<b>ZS 124</b>
2.1	2.1	70	08.85–07.92	MV	4	<b>ZM 012</b> <b>ZS 124</b>
2.1	2.1	82	08.87–07.89	DJ	4	<b>ZS 123</b>
2.1	2.1	82	08.85–07.92	DJ	4	<b>ZM 012</b> <b>ZS 124</b>
2.1 i	2.1	68	07.89–07.92	SS	4	<b>ZS 124</b>



kW

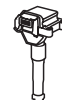

**VW AG**



**Bus/Transporter T 3**

2.1 KAT	2.1	70	06.89-07.92	MV	4	ZM 012	ZS 124	
2.1 Syncro	2.1	64	10.86-07.92	SR	4		ZS 124	
2.1 Syncro	2.1	70	08.85-07.92	MV	4	ZM 012	ZS 124	
2.1 Syncro	2.1	82	08.87-07.89	DJ	4		ZS 123	
2.1 Syncro	2.1	82	01.86-07.92	DJ	4	ZM 012	ZS 124	

**Bus/Transporter T 4**

1.8	1.8	49	12.90-07.92	PD	4	ZM 013	ZSE 001	
1.8	1.8	49	12.90-07.92	PD	4	ZM 014	ZSE 002	
2.0	2.0	62	09.90-12.93	AAC Fgst.Nr.→70-S-045000	4	ZM 013	ZSE 002	
2.0	2.0	62	09.90-12.93	AAC Fgst.Nr.70-S-045001→	4		ZSE 001	
2.5	2.5	81	11.90-04.03	AEN/AAF/ACU/AEU	5	ZM 013	ZSE 001	
2.5	2.5	85	08.96-04.03	APL	5	ZM 013		
2.5	2.5	85	08.96-04.03	AVT/AET/APL	5		ZSE 001	
2.5 Syncro	2.5	81	11.92-04.03	AEN/AAF/ACU/AEU	5	ZM 013	ZSE 001	
2.5 Syncro	2.5	85	07.96-04.03	AVT/AET/APL	5	ZM 013	ZSE 001	
2.8 V6	2.8	150	04.00-04.03	AMV	6		ZSE 004	
2.8 VR 6	2.8	103	11.95-04.00	AES	6		ZSE 004	

**Bus/Transporter T 5**

2.0	2.0	85	11.03-	AXA	4		ZSE 003	
2.0 TSI	2.0	110	07.12-	CJKB	4		ZSE 033	
2.0 TSI	2.0	150	05.11-	CJKA	4		ZSE 033 <sup>202</sup>	
2.0 TSI	2.0	150	05.11-	CJKA	4		ZSE 142 <sup>202</sup>	
2.0 TSI 4motion	2.0	150	07.11-	CJKA	4		ZSE 033 <sup>202</sup>	
2.0 TSI 4motion	2.0	150	07.11-	CJKA	4		ZSE 142 <sup>202</sup>	
3.2 4motion	3.2	170	11.03-06.06	BDL	6		ZSE 044	
3.2 V6	3.2	170	02.04-06.04	BDL	6		ZSE 044	
3.2 V6	3.2	173	02.04-11.09	BKK	6		ZSE 044	
3.2 V6 4motion	3.2	173	11.03-11.09	BKK/CFLA	6		ZSE 044	

**CADDY I**

1.6	1.6	55	01.83-07.92	EW	4		ZS 115	
1.8	1.8	70	08.85-09.86	JH	4	ZM 002	ZS 124	
1.8	1.8	70	10.86-07.92	JH	4	ZM 012	ZS 124	

**CADDY II**

1.4	1.4	55	08.00-01.04	AUA	4		ZSE 003	
60 1.4	1.4	44	11.95-01.04	AEX, APQ	4		ZSE 001	
60 1.4	1.4	44	11.95-01.04	AUD	4		ZSE 003	
75 1.6	1.6	55	11.95-05.97	1F	4		ZSE 001	

**CADDY III**

1.2 TSI	1.2	63	09.10-	CBZA	4		ZSE 003	
1.2 TSI	1.2	77	09.10-	CBZB	4		ZSE 003	
1.4	1.4	55	03.04-05.06	BCA	4		ZSE 030	
1.4 16V	1.4	59	05.06-08.10	BUD Fgst.Nr.→F1K-8-281 299	4		ZSE 030	
1.6	1.6	75	04.04-	BGU/BSF/BSE	4		ZSE 003	
1.6 BiFuel	1.6	75	05.11-	CHGA	4		ZSE 003	
2.0 EcoFuel	2.0	80	04.06-	BSX	4		ZSE 029	

**LT 28-35 I**

2.4	2.4	66	12.82-07.92	DL	6	ZM 002		
2.4 i	2.4	69	08.89-06.96	1E	6		ZS 124	

**LT 28-35 II**

2.3	2.3	105	05.96-07.06	AGL	4		ZS 340	ZLE 234
-----	-----	-----	-------------	-----	---	--	--------	---------

**LT 40-55 I**

2.4 i	2.4	69	01.93-06.96	1E	6		ZS 124	
-------	-----	----	-------------	----	---	--	--------	--

**MULTIVAN T5**

2.0	2.0	85	11.03-	AXA	4		ZSE 003	
2.0 TSI	2.0	110	07.12-	CJKB	4		ZSE 033	
2.0 TSI	2.0	150	05.11-	CJKA	4		ZSE 033 <sup>202</sup>	
2.0 TSI	2.0	150	05.11-	CJKA	4		ZSE 142 <sup>202</sup>	



kW



**VW AG**



**MULTIVAN T5**

2.0 TSI 4motion	2.0	150	07.11–	CJKA	4	<b>ZSE 033</b> <sup>202</sup>
2.0 TSI 4motion	2.0	150	07.11–	CJKA	4	<b>ZSE 142</b> <sup>202</sup>
3.2 4motion	3.2	170	11.03–06.06	BDL	6	<b>ZSE 044</b>
3.2 V6	3.2	170	02.04–06.04	BDL	6	<b>ZSE 044</b>

**WARTBURG**

**353**

1.0	1.0	37	02.75–08.88	353,18	3	<b>ZS 106</b>
1.3	1.3	43	09.88–05.91	4V07,2/7,5GRF	4	<b>ZM 012</b>
1.3	1.3	43	09.88–05.91	4V07,2/7,5GRF	4	<b>ZS 124</b>

**ZASTAVA**

**101**

1.1	1.1	40	06.73–01.90	128 A.000	4	<b>ZM 001</b>
1.1	1.1	41	05.75–12.93	128 A.064	4	<b>ZM 001</b>
1.1	1.1	41	05.75–12.93	128 A.064	4	<b>ZS 106</b>

**YUGO**

1.1 60 EFI	1.1	44	08.91–12.93	11 E 1.064/100 GL. 0.64	4	<b>ZM 029</b>
1.3 65 EFI	1.3	48	08.91–12.93	13 E 1.064	4	<b>ZM 029</b>

**YUGO FLORIDA**

1.3	1.3	50	03.91–12.93	13 E.3.064	4	<b>ZM 029</b>
-----	-----	----	-------------	------------	---	---------------



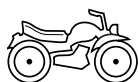

kW



### AGRATI-GARELLI

Gulp Lusso	50 ccm	1,1	07.74–12.80		1	<b>ZA 500</b>	
------------	--------	-----	-------------	--	---	---------------	--

### APRILIA

Dorsoduro	750 ccm	67	01.12–		2	<b>ZSE 130</b>	
Shiver	750 ccm	70	01.12–		2	<b>ZSE 130</b>	

### BATAVUS

Batavette S	50 ccm	1	06.79–12.85	505 2B	1	<b>ZA 510</b>	
Bingo (40 km/h)	50 ccm	0,7	03.74–10.80	Laura M 48	1	<b>ZA 509</b>	
Bingo V 25, VA 25	50 ccm	0,7	03.74–10.80	Laura M 48	1	<b>ZA 509</b>	
Go-Go (HS 50)	50 ccm		01.75–01.81		1	<b>ZA 509</b>	
Grand Prix	50 ccm	0,8	03.81–00.00	505 2B	1	<b>ZA 510</b>	
HS 60	50 ccm	1,1	06.79–09.81	505 2B	1	<b>ZA 510</b>	
Mot-O-Mat	50 ccm	1,1	06.79–12.85	505 2B	1	<b>ZA 510</b>	

### BENELLI

Tn T 899, -899 S	899 ccm	88	01.08–		3	<b>ZS 377</b>	
Trek 899	899 ccm	79	01.09–		3	<b>ZS 377</b>	

### BMW

F 650 GS	650 ccm	25	03.00–		1	<b>ZS 030</b>	<b>ZE 115</b>
F 650 GS	650 ccm	37	03.00–		1	<b>ZS 030</b>	<b>ZE 115</b>
F 650 GS	798 ccm	52	01.08–		2	<b>ZS 386</b>	
F 800 GS	798 ccm	63	01.08–		2	<b>ZS 386</b>	
F 800 R	798 ccm	64	01.09–		2	<b>ZS 386</b>	
F 800 S	798 ccm	64	01.06–		2	<b>ZS 386</b>	
F 800 ST	798 ccm	64	01.06–		2	<b>ZS 386</b>	
HP 2 Megamoto	1170 ccm	83	01.06–	Boxer (Doppelzündung)	2	<b>ZS 383 + ZS 385</b> Anbau links <sup>280</sup> <b>ZS 384 + ZS 385</b> Anbau rechts <sup>281</sup>	
HP 2 Sport / Enduro	1170 ccm	98	01.06–	Boxer (Doppelzündung)	2	<b>ZS 383 + ZS 385</b> Anbau links <sup>280</sup> <b>ZS 384 + ZS 385</b> Anbau rechts <sup>281</sup>	
K 1200 GT	1157 ccm	112	01.06–12.08		4	<b>ZS 386</b>	
K 1200 R	1157 ccm	120	01.05–12.08		4	<b>ZS 386</b>	
K 1200 R Sport	1157 ccm	120	01.06–		4	<b>ZS 386</b>	
K 1200 S	1157 ccm	123	01.05–12.08		4	<b>ZS 386</b>	
K 1300 GT	1293 ccm	118	01.08–		4	<b>ZS 386</b>	
K 1300 R	1293 ccm	127	01.09–		4	<b>ZS 386</b>	
K 1300 S	1293 ccm	134	01.08–		4	<b>ZS 386</b>	
R 45	475 ccm	26	06.78–08.80		1	<b>ZS 105</b>	
R 45/N	475 ccm	20	06.78–08.80		1	<b>ZS 105</b>	
R 60/7	600 ccm	29	09.78–06.80		1	<b>ZS 105</b>	
R 65	650 ccm	33	06.78–08.80		1	<b>ZS 105</b>	
R 75/7	750 ccm	37	09.76–08.79		1	<b>ZS 105</b>	
R 80/7 N	800 ccm	37	09.77–08.80		1	<b>ZS 105</b>	
R 80/7 S	800 ccm	40,5	09.77–08.80		1	<b>ZS 105</b>	
R 100 RS	980 ccm	52	09.76–09.78		2	<b>ZS 105</b>	
R 100 RS	980 ccm	52	09.76–09.80		2	<b>ZS 105</b>	
R 100 RT	980 ccm	52	09.78–09.80		2	<b>ZS 105</b>	
R 100 S	980 ccm	48-51	09.76–09.80		2	<b>ZS 105</b>	
R 100 T	980 ccm	47	09.78–09.80		2	<b>ZS 105</b>	
R 100/7	980 ccm	44	09.76–09.80		2	<b>ZS 105</b>	
R 850 C	850 ccm	25-37	10.97–		2	<b>ZS 224</b>	<b>ZE 116</b>
R 850 GS	900 ccm	52	01.98–		2	<b>ZS 224</b>	<b>ZE 116</b>
R 850 R	900 ccm	52	10.94–		2	<b>ZS 224</b>	<b>ZE 116</b>
R 900 RT (05SF, 10SF)	878 ccm	61	01.05–	Boxer (Doppelzündung)	2	<b>ZS 383 + ZS 385</b> Anbau links <sup>280</sup> <b>ZS 384 + ZS 385</b> Anbau rechts <sup>281</sup>	
R 1100 GS	1100 ccm	57-59	08.93–12.99		2	<b>ZS 224</b>	<b>ZE 116</b>
R 1100 R	1100 ccm	59	10.94–		2	<b>ZS 224</b>	<b>ZE 116</b>



kW



## BMW

R 1100 R Liberte	1100 ccm	59	01.96-		2	<b>ZS 224</b>	<b>ZE 116</b>
R 1100 RS	1100 ccm	66	11.92-		2	<b>ZS 224</b>	<b>ZE 116</b>
R 1100 RT	1100 ccm	66	09.95-		2	<b>ZS 224</b>	<b>ZE 116</b>
R 1100 S	1100 ccm	72	01.98-12.02		2	<b>ZS 224</b>	<b>ZE 116</b>
R 1100 S 98	1085 ccm	72	12.02-12.06		2	<b>ZS 385</b>	
R 1150 GS 00	1130 ccm	62,5	08.99-12.04		2	<b>ZS 385</b>	
R 1150 adv 01	1130 ccm	62,5	01.01-12.05		2	<b>ZS 385</b>	
R 1150 GS	1150 ccm	63	08.99-12.02	R 21	2	<b>ZS 224</b>	<b>ZE 116</b>
R 1150 R	1150 ccm	63	01.01-10.02	R 21	2	<b>ZS 224</b>	<b>ZE 116</b>
R 1150 R 01	1130 ccm	64	10.02-		2	<b>ZS 385</b>	
R 1150 R Rockster	1130 ccm	64	01.03-12.05		2	<b>ZS 385</b>	
R 1150 RS 01	1130 ccm	70	01.02-12.05		2	<b>ZS 385</b>	
R 1150 RT	1150 ccm	70	03.01-12.02		2	<b>ZS 224</b>	<b>ZE 116</b>
R 1150 RT 00	1130 ccm	70	12.02-12.05		2	<b>ZS 385</b>	
R 1200 C	1200 ccm	45	10.97-		2	<b>ZS 224</b>	<b>ZE 116</b>
R 1200 C Independent	1200 ccm	45	01.00-		2	<b>ZS 224</b>	<b>ZE 116</b>
R 1200 GS	1170 ccm	81	01.04-	Boxer (Doppelzündung)	2	<b>ZS 383 + ZS 385</b> Anbau links <sup>280</sup> <b>ZS 384 + ZS 385</b> Anbau rechts <sup>281</sup>	
R 1200 GS adv	1170 ccm	81	01.06-	Boxer (Doppelzündung)	2	<b>ZS 383 + ZS 385</b> Anbau links <sup>280</sup> <b>ZS 384 + ZS 385</b> Anbau rechts <sup>281</sup>	
R 1200 R	1170 ccm	80	01.06-	Boxer (Doppelzündung)	2	<b>ZS 383 + ZS 385</b> Anbau links <sup>280</sup> <b>ZS 384 + ZS 385</b> Anbau rechts <sup>281</sup>	
R 1200 RT	1170 ccm	81	01.05-	Boxer (Doppelzündung)	2	<b>ZS 383 + ZS 385</b> Anbau links <sup>280</sup> <b>ZS 384 + ZS 385</b> Anbau rechts <sup>281</sup>	
R 1200 S	1170 ccm	90	01.06-12.08	Boxer (Doppelzündung)	2	<b>ZS 383 + ZS 385</b> Anbau links <sup>280</sup> <b>ZS 384 + ZS 385</b> Anbau rechts <sup>281</sup>	
R 1200 ST	1170 ccm	81	01.05-12.07	Boxer (Doppelzündung)	2	<b>ZS 383 + ZS 385</b> Anbau links <sup>280</sup> <b>ZS 384 + ZS 385</b> Anbau rechts <sup>281</sup>	

## CLAEYS (FLANDRIA)

Daytona 4	50 ccm	1,1	10.76-10.81	6478	1	<b>ZA 509</b>	
Karina, Karina S	50 ccm	1	10.76-10.81	0275	1	<b>ZA 509</b>	
Record 4	50 ccm	1,1	10.76-10.81	6478	1	<b>ZA 509</b>	
Scrab	50 ccm	1,1	10.76-10.81	7478	1	<b>ZA 509</b>	

## DUCATI

620 Multistrada	618 ccm	46	01.06-		2	<b>ZS 507</b>	
695 Monster	695 ccm	53	01.06-		2	<b>ZS 507</b>	
696	696 ccm	59	01.08-		2	<b>ZS 441</b>	
748, 748 R			01.94-		2	<b>ZS 284</b>	
749 S	748 ccm	76	01.03-		2	<b>ZS 054</b> <sup>293</sup> nur in Verbindung mit Zündkerze Champion RG 4 HC	
749 S	748 ccm	76	01.03-		2	<b>ZS 085</b> <sup>61</sup> nur in Verbindung mit Zündkerze NGK MAR10-A-J	
750 SS, 750 SSI			01.94-		2	<b>ZS 284</b>	
800 S2R Monster	803 ccm	57	01.06-		2	<b>ZS 507</b>	
851			01.94-		2	<b>ZS 284</b>	
888			01.94-		2	<b>ZS 284</b>	
900 SS, 900 SSI, 900 SSIE			01.94-		2	<b>ZS 284</b>	
907			01.94-		2	<b>ZS 284</b>	

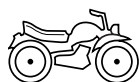

kW



### DUCATI

996, 996 SPS			01.94–		2	<b>ZS 284</b>	
998			01.94–		2	<b>ZS 284</b>	
999	998 ccm	91	01.03–		2	<b>ZS 054</b> <sup>293</sup> nur in Verbindung mit Zündkerze Champion RG 4 HC	
999	998 ccm	91	01.03–		2	<b>ZS 085</b> <sup>61</sup> nur in Verbindung mit Zündkerze NGK MAR10-A-J	
999 S	998 ccm	100	01.03–		2	<b>ZS 054</b> <sup>293</sup> nur in Verbindung mit Zündkerze Champion RG 4 HC	
999 S	998 ccm	100	01.03–		2	<b>ZS 085</b> <sup>61</sup> nur in Verbindung mit Zündkerze NGK MAR10-A-J	
999 R	998 ccm	102	01.03–		2	<b>ZS 054</b> <sup>293</sup> nur in Verbindung mit Zündkerze Champion RG 4 HC	
999 R	998 ccm	102	01.03–		2	<b>ZS 085</b> <sup>61</sup> nur in Verbindung mit Zündkerze NGK MAR10-A-J	
1000 DS Multistrada	992 ccm	62	01.03–		2	<b>ZS 056</b>	
1098 S	1099 ccm	119	01.07–		2	<b>ZS 085</b> <sup>61</sup> nur in Verbindung mit Zündkerze NGK MAR10-A-J	
Desmosedici	989 ccm	147	01.07–12.08		4	<b>ZS 444</b>	
ST2, ST4			01.94–		2	<b>ZS 284</b>	
Superbike Panigale	1199 ccm	143	01.12–		2	<b>ZS 439</b>	

### HERCULES

HR 2 Hobby Rider	50 ccm	1,1	06.79–12.81	505/2B	1	<b>ZA 510</b>	
MK 2 S	50 ccm	1,5	06.79–08.80	501/3BKF	1	<b>ZA 510</b>	
MP 2, 4	50 ccm		10.72–12.77		1	<b>ZA 509</b>	
Prima 4, 4 N	50 ccm		06.79–08.80		1	<b>ZA 510</b>	
Prima 5 S	50 ccm	0,8	06.79–08.80	505/2B	1	<b>ZA 510</b>	
Prima 5, 5 N	50 ccm		06.79–08.80		1	<b>ZA 510</b>	
Prima 6	50 ccm		06.79–08.80		1	<b>ZA 510</b>	
Prima G 3	50 ccm		06.79–08.80		1	<b>ZA 510</b>	
Prima S	50 ccm		09.80–00.00		1	<b>ZA 509</b>	

### KREIDLER

Flory (MF 12, 13)			01.76–10.80		1	<b>ZA 509</b>	
Flory (MF 12, 13)			11.80–12.80		1	<b>ZA 510</b>	
Flory (MF 20, 22)			03.79–03.82		1	<b>ZA 509</b>	
Flory SL	50 ccm	1,1	08.77–10.80	MF 23	1	<b>ZA 509</b>	
Flory SL (MF 23)			11.80–12.80		1	<b>ZA 510</b>	
LF-F			04.78–03.82		1	<b>ZA 501</b>	
RM (K 54/421)	50 ccm	2,1	01.76–03.82		1	<b>ZA 501</b>	
RMC .. (K 54/421)	50 ccm	2,1	01.76–03.82		1	<b>ZA 501</b>	

### KTM

Comet	50 ccm		09.76–12.80		1	<b>ZA 501</b>	
Mofa, Moped	50 ccm		02.81–12.83		1	<b>ZA 510</b>	
Mofa, Moped	50 ccm		09.76–01.81		1	<b>ZA 509</b>	
Super Duke R 990	999 ccm	97	01.08–12.10		2	<b>ZS 443</b>	

### LAVERDA

750 GTL	750 ccm	38	10.74–12.79		1	<b>ZS 106</b>	
---------	---------	----	-------------	--	---	---------------	--

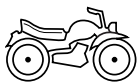

kW



## MAICO

125 GS/6	125 ccm	18	11.70–05.83		1	<b>ZS 105</b>
----------	---------	----	-------------	--	---	---------------

## MÜNCH

1200 TTS-E	1200 ccm	65	05.73–12–82	NSU Einspritzmotor	4	<b>ZS 115</b>
------------	----------	----	-------------	--------------------	---	---------------

## MV AGUSTA

Brutale 910	909 ccm	100	01.05–		4	<b>ZS 378</b>
Brutale 910 R	909 ccm	101	01.06–		4	<b>ZS 378</b>
Brutale 989 R	982 ccm	104	01.08–		4	<b>ZS 378</b>
Brutale 990 R	998 ccm	102	01.10–		4	<b>ZS 378</b>
Brutale F4 1000 R 312	998 ccm	134	01.08–		4	<b>ZS 378</b>
Brutale F4 1078 RR 312	1078 ccm	140	01.06–		4	<b>ZS 378</b>

## PIAGGIO (MOTO VESPA)

MP3 125	125 ccm	11			1	<b>ZS 440</b>
MP3 250	250 ccm	16			1	<b>ZS 440</b>
MP3 400	400 ccm	25			1	<b>ZS 440</b>
VESPA 250 GTS	250 ccm		06.05–		1	<b>ZS 078</b>

## RIXE

Champion FTH	50 ccm	1	06.79–08.80		1	<b>ZA 510</b>
Champion FTH, FT	50 ccm	1	06.79–08.80	505/1B	1	<b>ZA 510</b>
High-Sport	50 ccm		06.79–08.80		1	<b>ZA 510</b>
High-Sport Super L	50 ccm	1	06.79–08.80	505/2B	1	<b>ZA 510</b>
Libelle GHT	50 ccm	1	06.79–08.80	505/2B	1	<b>ZA 510</b>
Libelle High-Sport Super R 503	50 ccm		06.79–08.80		1	<b>ZA 510</b>
RS 50 B III, B IV	50 ccm	2,1	09.78–12.82	501/4, 5BFK	1	<b>ZA 501</b>
Tourismo E 21 E, EL	50 ccm	1,1	06.79–08.80	505/2B	1	<b>ZA 510</b>
Tourismo SL 40	50 ccm	1,8-2	06.79–08.80	505/2C	1	<b>ZA 510</b>

## SPARTA

Happy	50 ccm	1,1	06.79–12.81	505/2B	1	<b>ZA 510</b>
-------	--------	-----	-------------	--------	---	---------------

## STEYR-DAIMLER-PUCH

Dakota 3000	50 ccm		06.75–06.80		1	<b>ZA 500</b>
Dakota 3000	50 ccm		07.80–00.00		1	<b>ZA 501</b>
DS 50 L (A)	50 ccm		09.75–09.80		1	<b>ZA 501</b>
Maxi 2-25	50 ccm		01.73–07.77		1	<b>ZA 509</b>
Maxi L (A)	50 ccm		04.71–05.79		1	<b>ZA 509</b>
Maxi L 2	50 ccm	1	06.79–12.82		1	<b>ZA 510</b>
MC 50-3	50 ccm	1	10.78–12.81		1	<b>ZA 501</b>
MV 50 Stockvis/Casablanca	50 ccm		06.79–09.80		1	<b>ZA 510</b>
N 50-4 Monza	50 ccm		01.76–12.81		1	<b>ZA 501</b>
X 30 A	50 ccm	1,1	06.79–12.81		1	<b>ZA 510</b>
X 40 M	50 ccm	0,9	06.79–12.83		1	<b>ZA 510</b>
X 50-2 M	50 ccm	1,1	09.78–12.82		1	<b>ZA 501</b>
X 50-3	50 ccm	1,6	09.78–12.82		1	<b>ZA 510</b>

## ZÜNDAPP

CS 25	50 ccm		06.80–12.84	278-56	1	<b>ZA 509</b>
CS 50	50 ccm	2,1	09.79–12.84	280-78	1	<b>ZA 509</b>
GTS 50 (5-Gang)	50 ccm	2,1	07.79–05.82	284-21	1	<b>ZA 509</b>
Hai 25	50 ccm	1	06.80–05.82	278-57	1	<b>ZA 509</b>
Hai 50	50 ccm	2,5	10.80–05.82	280-78	1	<b>ZA 509</b>
R 50	50 ccm		04.70–05.82	561-05	1	<b>ZA 501</b>
ZD 30, ZD 20	50 ccm		09.79–07.80	446-20, 446-40	1	<b>ZA 501</b>
ZD 40	50 ccm		09.76–05.82	446-30	1	<b>ZA 501</b>
ZD 50 TS	50 ccm		09.78–07.80	446-42	1	<b>ZA 501</b>
ZL 25	50 ccm		09.80–05.82	460-04	1	<b>ZA 509</b>
ZS 25	50 ccm		09.81–05.82	278-18	1	<b>ZA 509</b>
ZX 25	50 ccm	1	09.79–01.81	278-12	1	<b>ZA 509</b>
ZX 25	50 ccm	1	02.81–12.84	278-12	1	<b>ZA 510</b>



kW

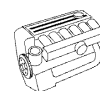

### BMW (D)

B 130	2,0	86	12.78–07.87	B 130	<b>ZS 115</b>
B 190	2,8	122	03.78–07.87	B 190	<b>ZS 115</b>
B 220	3,2	136	03.78–07.87	B 220	<b>ZS 115</b>
410	1,8	81	01.69–12.79	410	<b>ZS 115</b>
411	2,0	85	01.69–12.79	411	<b>ZS 115</b>

### BPM (I)

Arctic 157, 181	4,2	103	01.62–12.87	Arctic 157, 181	<b>ZS 115</b>
Ionic 127	3,0	93–106	06.72–10.78	Ionic 127	<b>ZS 115</b>
Ionic 144	3,0	93	06.72–12.88	Ionic 144	<b>ZS 115</b>
Oceanic 235	5,7	151	01.63–12.87	Oceanic 235	<b>ZS 115</b>
Oceanic 265 S	5,7	169	01.63–12.90	Oceanic 265 S	<b>ZS 115</b>
V 12/570	12,0	338	06.72–12.90	V 12/570	<b>ZS 115</b>
V 12/620 S	12,0	368	06.72–12.90	V 12/620 S	<b>ZS 115</b>
Vulcano 375	8,0	250	01.68–12.80	Vulcano 375	<b>ZS 115</b>
Vulcano 450	7,9	279	01.68–12.80	Vulcano 450	<b>ZS 115</b>

### TOMOS

Tomos 3, 4			06.74–01.81		<b>ZA 509</b>
Tomos 3, 4			02.81–12.90		<b>ZA 510</b>

### VOLVO PENTA

AQ 140 A	2,3	92	11.75–12.79	AQ 140 A	<b>ZS 106</b>
AQ 145 A	2,3	101	03.79–12.85	AQ 145 A	<b>ZS 106</b>
MB 10 A	1,0	11	04.71–12.77	MB 10 A	<b>ZS 106</b>
MB 10 A	1,0	11	11.74–09.81	MB 10 A	<b>ZS 106</b>
MB 20 B			01.73–01.80	MB 20 B (Petroleum)	<b>ZS 106</b>

### WICKSTRÖM

W 1	0,6	4,4	01.77–01.80	W 1	<b>ZS 106</b>
W 1	0,6	3,7	01.77–01.80	W 1 (Petroleum)	<b>ZS 106</b>
W 2	1,1	9,6	01.77–01.80	W 2	<b>ZS 106</b>
W 2	1,1	8,1	01.77–01.80	W 2 (Petroleum)	<b>ZS 106</b>
W 3	1,7	15	01.77–01.80	W 3	<b>ZS 106</b>
W 3	1,7	13	01.77–01.80	W 3 (Petroleum)	<b>ZS 106</b>



kW

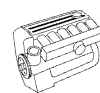

**AGRIA**

0300	100		03.78–01.81	llo-101	<b>ZA 509</b>
0300	100		02.81–12.83	llo-101	<b>ZA 510</b>

**AS-MOTOR**

AS 1 SL			05.72–12.80		<b>ZA 509</b>
AS 4			05.72–12.80		<b>ZA 509</b>
AS 21 H 6, AH 6	80	2,2	01.76–12.80		<b>ZA 509</b>
AS 26 AH 4	90	2,9	01.74–06.81		<b>ZA 509</b>
AS 26 H 4, AH 4			01.74–12.80		<b>ZA 509</b>
AS 42 B 6	80	2,2	01.76–06.81		<b>ZA 509</b>

**GUTBROD**

ATO 77			01.70–01.81		<b>ZA 509</b>
ATO 77			02.81–12.83		<b>ZA 510</b>
T 1 E			02.81–12.84		<b>ZA 510</b>
T 113			02.81–12.84		<b>ZA 510</b>
T 114 L			02.81–12.84		<b>ZA 510</b>
T 116			02.81–12.84		<b>ZA 510</b>
T 650			02.81–12.84		<b>ZA 510</b>

**SOLO**

419 Trac			01.72–12.80		<b>ZA 509</b>
419 Trac			01.81–12.84		<b>ZA 510</b>
424, 426 Minor			01.72–09.80		<b>ZA 509</b>
424, 426 Minor			10.80–12.83		<b>ZA 510</b>



kW

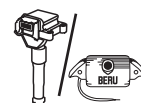
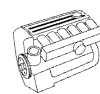

**STIHL**

070, AV			01.63–12.80		<b>ZA 510</b>
090, AV			07.81–05.89		<b>ZA 510</b>



kW



### BETAMOTOR

B 205	200	4,8	01.71–06.91	<b>ZA 510</b>
B 207	200	6,6	01.71–12.87	<b>ZA 510</b>

### BMW

A 67 Pumpe (Feuerwehr)	1170	50		Boxer (Doppelzündung)	<b>ZS 383 + ZS 385</b> Anbau links <sup>280</sup> <b>ZS 384 + ZS 385</b> Anbau rechts <sup>281</sup>
------------------------	------	----	--	-----------------------	---

### FICHTEL & SACHS AG

Famo 50	50		01.66–01.81		<b>ZA 509</b>
Famo 50	50		02.81–12.88		<b>ZA 510</b>
Famo 50/AEX	50	2,2	03.78–01.81		<b>ZA 509</b>
Famo 50/AEX	50	2,2	02.81–12.88		<b>ZA 510</b>
Famo 50/ALS	50		06.70–12.80		<b>ZA 500</b>
Famo 50/AMLC	50		01.66–01.81		<b>ZA 509</b>
Famo 50/AMLC	50		02.81–12–88		<b>ZA 510</b>
Famo 50/AMLS	50		02.74–12.88		<b>ZA 500</b>
Famo 50/AS	50	1,2	06.70–12.77		<b>ZA 500</b>
Famo 50/MC	50	1,2	09.70–05.79		<b>ZA 509</b>
Famo 50/MC	50		06.79–12.80		<b>ZA 510</b>
Famo 50/1 MASF, MAX	50		06.79–12.88		<b>ZA 510</b>
Famo 50/1 MB, MI	50		06.79–12.88		<b>ZA 510</b>
Famo 50/1 MNL	50		01.66–01.81		<b>ZA 509</b>
Famo 50/1 MNL	50		02.81–12.88		<b>ZA 510</b>
Famo 50/2 C	50		01.66–01.81		<b>ZA 509</b>
Famo 50/2 C	50		02.81–12.88		<b>ZA 510</b>
Famo 50/2 DK	50		06.69–05.79		<b>ZA 509</b>
Famo 50/2 DK	50		06.79–12.88		<b>ZA 510</b>
Famo 50/2 DNL	50	1,3	06.79–12.81		<b>ZA 510</b>
Famo 50/2 KDK	50		06.79–12.88		<b>ZA 510</b>
Famo 50/2 KS, MAKSF	50		06.79–12.88		<b>ZA 510</b>
Famo 50/2 MANL, MASF	50		06.79–12.88		<b>ZA 510</b>
Famo 50/2 MAX	50	1,8	06.79–12.81		<b>ZA 510</b>
Famo 50/2 MB, MLB	50		06.79–12.88		<b>ZA 510</b>
Famo 50/2 MLAX	50	1,8	06.79–12.81		<b>ZA 510</b>
Famo 50/2 MLC	50		01.66–05.79		<b>ZA 509</b>
Famo 50/2 MLC	50		06.79–12.88		<b>ZA 510</b>
Famo 50/3 CNL	50		06.79–12.81		<b>ZA 510</b>
Famo 50/3 CNL	50		08.71–12.81		<b>ZA 500</b>
Famo 50/3 D	50		06.78–01.81		<b>ZA 509</b>
Famo 50/3 D	50		02.81–12.88		<b>ZA 510</b>
Famo 50/3 KFS	50		09.73–12.81		<b>ZA 500</b>
Famo 50/3 KHNL, 50/3 MAKFX	50		06.78–12.88		<b>ZA 500</b>
Famo 50/3 LS	50		06.79–12.88		<b>ZA 510</b>
Famo 50/3 LS	50		01.66–12.88		<b>ZA 509</b>
Famo 50/3 MAI	50		06.79–12.81		<b>ZA 510</b>
Famo 50/3 MAX	50		01.66–01.81		<b>ZA 509</b>
Famo 50/3 MAX	50		02.81–12.84		<b>ZA 510</b>
Famo 50/3 MB	50		01.66–01.81		<b>ZA 509</b>
Famo 50/3 MB	50		02.81–12.84		<b>ZA 510</b>
Famo 50/3 MLAX	50		01.66–01.81		<b>ZA 509</b>
Famo 50/3 MLAX	50		02.81–12.84		<b>ZA 510</b>
Famo 50/3 MLFB	50		06.79–12.88		<b>ZA 510</b>
Famo 50/3 MLKAX	50		06.79–12.88		<b>ZA 510</b>
Famo 50/3 MLKB	50		06.79–12.88		<b>ZA 510</b>
Famo 50/4 CFNL	50		04.73–12.81		<b>ZA 500</b>
Famo 50/4 DFX	50	2,2	06.78–12.84		<b>ZA 500</b>
Famo 50/4 LKH	50	3,2	06.79–09.86		<b>ZA 510</b>
Famo 50/4 MLFANL, 50/4 MLFB	50	1,9	01.66–12.84		<b>ZA 500</b>
Famo 50/4 MLKAX	50	1,8	01.66–09.86		<b>ZA 500</b>
Famo 501/3 BF, 501/4 BF	50	1,5	01.75–12.81		<b>ZA 501</b>
Famo 501/3 BKF	50	2,1	10.70–12.81		<b>ZA 501</b>



kW

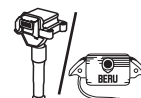
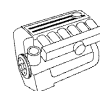

## FICHTEL & SACHS AG

Famo 501/4 AKF, 501/4 BKF	50	2,1	08.67–12.84		<b>ZA 501</b>
Famo 501/4 AKFX	50	2,1	04.73–12.82		<b>ZA 501</b>
Famo 505/1 A	50	1,3	12.74–01.81		<b>ZA 509</b>
Famo 505/1 A	50	1,3	02.81–12.88		<b>ZA 510</b>
Famo 505/1 C	50	1,8	10.74–01.81		<b>ZA 509</b>
Famo 505/1 C	50	1,8	02.81–12.88		<b>ZA 510</b>
Famo 505/2 A, CK	50	1,8	05.75–01.81		<b>ZA 509</b>
Famo 505/2 A, CK	50	1,8	02.81–12.82		<b>ZA 510</b>
Famo 505/2 AK	50		05.75–01.81		<b>ZA 509</b>
Famo 505/2 AK	50		02.81–12.84		<b>ZA 510</b>
Famo 505/2 B, C	50		10.74–01.81		<b>ZA 509</b>
Famo 505/2 B, C	50		02.81–12.84		<b>ZA 510</b>

## ILO

RM 97	100	2,9	02.81–12.87		<b>ZA 510</b>
M 48		1,25	01.65–01.81		<b>ZA 509</b>
M 54		1,25	07.74–01.81		<b>ZA 509</b>

## MAG (MOTOSACOCHE SA)

2076 SRL	800	12	10.75–12.78	2076 SRL	<b>ZS 220</b>
----------	-----	----	-------------	----------	---------------

## PERKINS

900-Serie / 3-Zylinder (Gabelstapler) <sup>130, (52)</sup>				Gasmotor <sup>51</sup>	<b>ZS 049</b>
1000-Serie / 4-Zylinder (Gabelstapler) <sup>130, (52)</sup>				Gasmotor <sup>51</sup>	<b>ZS 049</b>

## ROTAX (BOMBARDIER-ROTAX GMBH)

Stamo 125, 150, 150 H			03.75–01.81		<b>ZA 509</b>
Stamo 125, 150, 150 H			02.81–12.83		<b>ZA 510</b>
Stamo 151, 165, 185			03.75–01.81		<b>ZA 509</b>
Stamo 151, 165, 185			02.81–12.83		<b>ZA 510</b>

## STEYR (STEYR-DAIMLER-PUCH)

AX 25 (E)			09.78–01.81		<b>ZA 509</b>
AX 25 (E)			02.81–12.83		<b>ZA 510</b>
Cobra T 50-4 (A, B)	50	2	03.77–12.83		<b>ZA 501</b>
Cobra T 50-4 (D, F)	50	2	03.77–12.83		<b>ZA 501</b>
M 50 S (E)			08.77–01.81		<b>ZA 509</b>
M 50 S (E)			02.81–12.83		<b>ZA 510</b>
Maxi			01.70–01.81	KTM	<b>ZA 509</b>
Maxi			02.81–12.83	KTM	<b>ZA 510</b>
Maxi Schweiz			03.77–01.81	Alpa	<b>ZA 509</b>
Maxi Schweiz			02.81–12.83	Alpa	<b>ZA 510</b>
Maxi Schweiz			03.77–01.81	Gränichen	<b>ZA 509</b>
Maxi Schweiz			02.81–12.83	Gränichen	<b>ZA 510</b>
Maxi 2 A			09.78–01.81	KTM	<b>ZA 509</b>
Maxi 2 A			02.81–12.83	KTM	<b>ZA 510</b>
Monza 4-Gang			09.78–12.80	KTM	<b>ZA 509</b>
Ranger 4 TL (D)			09.78–12.80		<b>ZA 509</b>
VS 50 D, V (E)			08.77–01.81		<b>ZA 509</b>
VS 50 D, V (E)			02.81–12.83		<b>ZA 510</b>
X 30 Cross (F)			09.78–01.81		<b>ZA 509</b>
X 300 Cross (F)			02.81–12.83		<b>ZA 510</b>

## TOMOS

60 ccm	60	2	06.74–07.80		<b>ZA 509</b>
60 ccm	60	2	08.77–01.81		<b>ZA 509</b>
60 ccm	60	2	02.81–12.83		<b>ZA 510</b>





kW

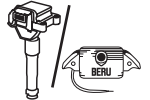
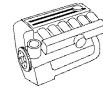

**VOLKSWAGEN**

122.2	1200	20	01.65-01.90	122.2	<b>ZS 106</b>
122.2	1200	23	01.65-01.90	122.2	<b>ZS 105</b>
126.A	1600	27-31	01.65-01.90	126.A	<b>ZS 106</b>
127	1800	24-49	07.74-08.83	127	<b>ZS 106</b>

Original BERU Markenprodukte werden nach strengsten Qualitätsvorgaben hergestellt. Um eine einwandfreie Funktion zu gewährleisten, beachten Sie bitte folgende Montagehinweise.

Original BERU Brand Products are Manufactured in Compliance with strict quality-control requirements. Please heed the following mounting instructions to ensure proper functioning of the products.

Les produits d'origine de marque BERU sont fabriqués selon des directives de qualité les plus sévères. Veuillez observer les instructions de montage suivantes, pour garantir un fonctionnement impeccable.

## Zündmodule

1. Zündung abschalten  
Vor dem Ausbau des Zündmoduls 15 Minuten warten. Damit werden Spannungsspitzen, die zur Zerstörung von Steuergeräten führen können, vermieden
2. Defektes Zündmodul ausbauen
3. Die Auflagefläche an der Karosserie bzw. am Zündverteiler von Schmutzpartikeln und Oxidationen befreien
4. Auflagefläche, nur wenn beigelegt, mit Wärmeleitpaste bestreichen
5. Neues Zündmodul einbauen
6. Stecker auf Oxidation prüfen und ggf. reinigen

## Ignition Modules

1. Switch off the ignition  
Wait for 15 min before demounting the regulator. This prevents voltage peaks that could destroy control devices
2. Remove the defective ignition module
3. Remove dirt particles and oxidation from the bearing areas of the car body and the ignition distributor
4. Apply heat-conductive paste to the bearing areas, provided this paste is included in the scope of delivery
5. Install the new ignition module
6. Check the plugs for oxidation and clean it, if necessary

## Modules d'allumage

1. Coupez l'allumage  
Attendez 15 minutes avant de démonter le module d'allumage. Ceci permet d'éviter les crêtes de tension qui pourraient entraîner la destruction des boîtiers électroniques de commande.
2. Démontez le module d'allumage défectueux
3. Nettoyez la surface d'appui sur la carrosserie ou sur le distributeur d'allumage de toute particule de poussière et de tout agent oxydant.
4. Enduisez la surface d'appui – seulement si jointe – avec la pâte thermoconductrice
5. Montez le nouveau module d'allumage
6. Vérifiez la présence d'agents oxydants sur le connecteur et, le cas échéant, nettoyez-les

Originele BERU merkproducten worden volgens zeer strenge kwaliteitseisen vervaardigd. Om een correcte functie te garanderen, dient u op de volgende montageaanwijzingen te letten.

Los productos originales de la marca BERU se fabrican según las normas más estrictas de calidad. Para garantizar un funcionamiento impecable, observe las siguientes indicaciones para el montaje.

I prodotti originali di marca BERU vengono realizzati secondo i più severi criteri di qualità. Al fine di poter garantire una funzione perfetta, si prega di osservare le seguenti istruzioni per il montaggio.

### Ontstekingsmodule

1. Ontsteking uitschakelen  
Wacht 15 minuten voor de demontage van de ontstekingsmodule. Daardoor worden spanningspieken voorkomen die de besturingsapparaten zouden kunnen vernielen
2. Defecte ontstekingsmodule demonteren
3. Het oplegvlak aan de carrosserie c.q. aan de ontstekingsverdeler van vuildeeltjes en oxidaties ontdoen
4. Oplegvlak alleen wanneer bijgevoegd met warmtegeleidingspasta insmeren
5. Nieuwe ontstekingsmodule inbouwen
6. Stekker op oxidatie controleren en evt. reinigen

### Módulos de encendido

1. Desconecte el encendido.  
Espere 15 minutos antes de desmontar el regulador. De esta forma se evitan picos de tensión que puedan dar lugar al deterioro de los aparatos de control.
2. Desmonte el módulo de encendido defectuoso.
3. Limpie las partículas de suciedad y oxidaciones de la superficie de apoyo de la carrocería o del distribuidor de encendido.
4. Aplique la pasta calorífica (si la tiene) sobre la superficie de apoyo.
5. Instale el nuevo módulo de encendido.
6. Compruebe los enchufes con respecto a oxidaciones y límpielos, si es necesario.

### Ignition Modules

1. Disinserire l'accensione  
Prima di montare il regolatore attendere almeno 15 minuti. In tal modo si prevengono picchi di tensione, che possono avere la conseguenza di una distruzione delle unità di controllo
2. Smontare il modulo d'accensione difettoso
3. Eliminare le particelle di impurità e di ossidazione dalla superficie d'appoggio alla carrozzeria e del distributore d'accensione
4. Pennellare la superficie d'appoggio con della pasta termoconduttiva, solo se disponibile
5. Montare il nuovo modulo d'accensione
6. Controllare la connessione per la presenza di ossidazione, pulirla all'occorrenza



Оригинальные фирменные компоненты BERU изготавливаются согласно жестким нормам качества. Чтобы обеспечить исправную работу, монтаж должен быть выполнен в соответствии со следующими указаниями.

Oryginalne markowe produkty BERU są produkowane zgodnie z surowymi standardami jakości. Aby zagwarantować sprawne działanie należy przestrzegać następujących zasad montażu.

Τα αυθεντικά επώνυμα προϊόντα BERU έχουν κατασκευαστεί με τις πιο αυστηρές προδιαγραφές ποιότητας. Για να διασφαλιστεί η απρόσκοπτη λειτουργία, παρακαλούμε προσέξτε τις παρακάτω υποδείξεις συναρμολόγησης.

## Модули системы зажигания

1. Выключить зажигание  
Перед демонтажом модуля системы зажигания выждать 15 минут. Это позволяет предотвратить пики напряжения, которые могут стать причиной повреждения устройств управления
2. Демонтировать дефектный модуль системы зажигания
3. Очистить опорную поверхность на кузове и на распределителе зажигания от частиц грязи и окислов
4. Покрыть опорную поверхность теплопроводящей пастой, если она имеется в комплекте
5. Установить новый модуль системы зажигания
6. Проверить штекер на наличие окислов и при необходимости очистить

## Moduły zapłonowe

1. Wyłączyć zapłon  
Przed demontażem modułu zapłonowego odczekać 15 minut. Uniknie się dzięki temu szczytowych napięć, które mogłyby uszkodzić sterowniki
2. Wymontować uszkodzony moduł zapłonowy
3. Powierzchnię styku na karoserii wzgl. rozdzielaczu zapłonu wyczyścić z zabrudzeń i utlenienia
4. Powierzchnię styku, o ile dołączono, nasmarować pastą termoprzewodzącą
5. Zamontować nowy moduł zapłonowy
6. Sprawdzić wtyczkę, czy nie jest utleniona i w razie potrzeby wyczyścić

## Συγκροτήματα ανάφλεξης

1. Απενεργοποιήστε την ανάφλεξη  
Πριν από την αφαίρεση του συγκροτήματος ανάφλεξης, περιμένετε 15 λεπτά. Έτσι αποφεύγονται οι αιχμές τάσης, που θα μπορούσαν να οδηγήσουν σε καταστροφή των μονάδων ελέγχου
2. Αφαιρέστε το ελαττωματικό συγκρότημα ανάφλεξης
3. Καθαρίστε τα σωματίδια ρύπων και τις οξειδώσεις από την επιφάνεια επαφής στο αμάξωμα ή στο διανομέα ανάφλεξης
4. Επαλείψτε την επιφάνεια επαφής με θερμοαγώγιμη πάστα, μόνο όταν περιλαμβάνεται στην παράδοση
5. Τοποθετήστε ένα καινούργιο συγκρότημα ανάφλεξης
6. Ελέγξτε το συνδετήρα για οξείδωση και αν χρειαστεί καθαρίστε τον

Az eredeti BERU márkájú termékek gyártása a legszigorúbb minőségi előírások szerint történik. A kifogástalan működés biztosítása érdekében kérjük, vegye figyelembe a következő szerelési tudnivalókat.

Os produtos da marca Beru originais são fabricados sob os mais rígidos requisitos de qualidade. Respeite as seguintes indicações de montagem para garantir um funcionamento sem problemas.

Orijinal BERU markalı ürünler en sıkı kalite spesifikasyonlarına göre üretilir. Kusursuz bir çalışmayı garanti etmek için lütfen aşağıdaki montaj bilgilerine dikkat ediniz.

### Gyújtómodulok

1. Kapcsolja le a gyújtást.  
A gyújtómodul kiszérése előtt várjon 15 percet. Ezzel elkerülhetők azok a feszültségcsúcsok, amelyek a vezérlőkészülékek tönkretételéhez vezethetnek.
2. Szerelje ki a hibás gyújtómodult.
3. Tisztítsa meg a karosszérián, ill. a gyújtáselosztón a felfekvőfelületet a szennyeződésektől és az oxidációtól.
4. Ha mellékeltek hővezető pasztát, akkor kenje be vele a felfekvőfelületet.
5. Szerelje be az új gyújtómodult.
6. Ellenőrizze a dugaszt oxidálódás szempontjából és szükség esetén tisztítsa meg.

### Módulos de ignição

1. Desligar a ignição  
Aguardar 15 minutos antes de desmontar o módulo de ignição. Desta forma são evitados os picos de tensão que podem causar a destruição das unidades de comando
2. Desmontar o módulo de ignição defeituoso
3. Eliminar as partículas de sujidade e as oxidações na superfície de apoio da carroçaria ou do distribuidor de ignição
4. Aplicar uma pasta termocondutora na superfície de apoio, apenas se esta for juntamente fornecida
5. Montar o novo módulo de ignição
6. Verificar se existe oxidação na ficha e limpar se necessário

### Ateşleme modülleri

1. Kontakı kapatınız  
Ateşleme modülünü sökmeden önce 15 dakika bekleyiniz. Bu sayede, kontrol ünitelerinin zarar görmesine neden olan uç gerilimler önlenir
2. Arızalı ateşleme modülünü sökünüz
3. Gövdedeki veya distribütördeki temas yüzeyinde bulunan kir parçacıkları ve oksitlenmeleri temizleyiniz
4. Temas yüzeyine, sadece birlikte verilmişse ısı iletken macun sürünüz
5. Yeni ateşleme modülünü takınız
6. Soketi oksitlenme açısından kontrol ediniz ve gerekirse temizleyiniz

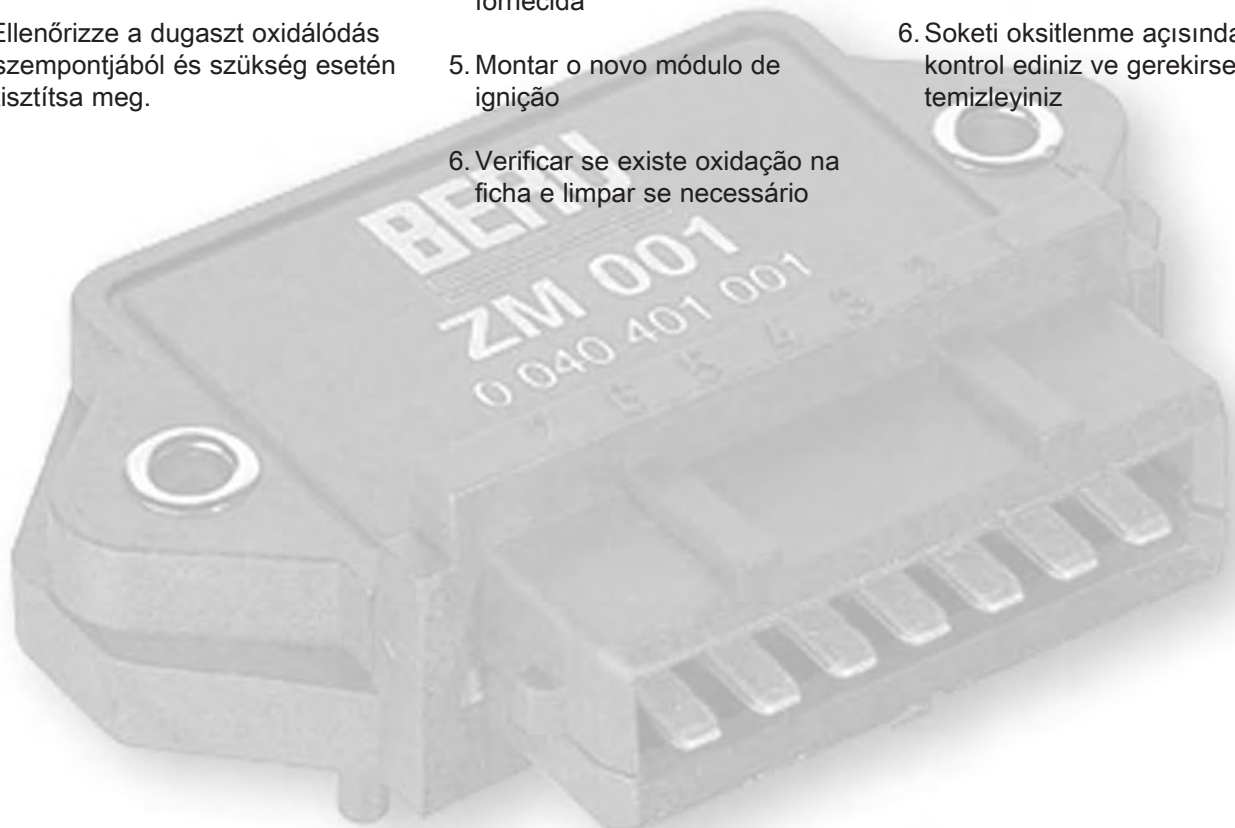

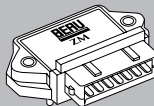

**ZM 001**  
0 040 401 001

**Bosch**  
Bosch 0 227 100 102  
Ducellier 521008  
Magneti Marell 64833020  
Peugeot 5945.48  
Volvo 1 298 429



Alfa Romeo, BMW, Fiat, Lancia, Mercedes Benz, Peugeot, Porsche, Renault, Seat, Saab, Talbot, Volvo, Zastava

induktiv<sup>207</sup>  
6 Anschlüsse<sup>170</sup>

**ZM 005**  
0 040 401 005

**Delco**  
Delco Remy D 1906  
Fiat/Lancia 4419 628  
Lucas DAB 125  
Magneti Marelli BKL 1A  
Renault 7701 021 955



Alfa Romeo, Austin Rover, Fiat, GM, Jaguar, Lancia, Leyland, Peugeot, Renault, Seat

induktiv<sup>207</sup>  
2+2 Anschlüsse<sup>170</sup>

**ZM 002**  
0 040 401 002

**Bosch**  
Bosch 0 227 100 103,  
0 227 100 118,  
0 227 100 137,  
0 227 100 139  
Opel 12 08 033  
Volvo 1 317 809  
VW 211 905 351A, B, D, E



Alfa Romeo, Audi, Bedford, Lada, Nissan, Opel, Peugeot, Porsche, Saab, Mercedes Benz, Seat, Vauxhall, VW, Volvo, Yugo

Hall<sup>208</sup>  
7 Anschlüsse<sup>170</sup>

**ZM 006**  
0 040 401 006

**Delco**  
Delco Remy D 1959  
AMC 8134117  
GM / Vauxhall 1978 778  
Lucas DAB 700  
Opel 12 11 560



Bedford, Opel, Vauxhall

induktiv<sup>207</sup>  
2+2 Anschlüsse<sup>170</sup>

**ZM 003**  
0 040 401 003

**Bosch**  
Bosch 0 227 100 140,  
1 137 010 025  
Citroën 9453130480  
Lucas DAB 401  
Peugeot 5945.45



Citroën, Ford, Oltcit (RO), Peugeot, Reliant

induktiv<sup>207</sup>  
2+3 Anschlüsse<sup>170</sup>

**ZM 007**  
0 040 401 007

**Delco**  
Delco Remy D 1951, 7033103  
GM 1985 703  
Opel 12 11 561



Bedford, Opel, Vauxhall

induktiv<sup>207</sup>  
3+3 Anschlüsse<sup>170</sup>

**ZM 004**  
0 040 401 004

**Bosch**  
Bosch 0 227 100 114,  
0 227 100 115  
Mercedes Benz 002 545 18 32,  
002 545 58 32,  
002 545 90 32



Mercedes-Benz

induktiv<sup>207</sup>  
2+4 Anschlüsse<sup>170</sup>

**ZM 008**  
0 040 401 008

**Lucas**  
Delco Remy 16 010 888  
Bosch 1 227 022 003  
Ford 81SF-12K059-AB,  
60 86 506  
Lucas DAB 101



Ford, Morgan, Reliant

induktiv<sup>207</sup>  
4 Anschlüsse<sup>170</sup>

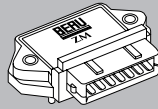
**ZM 009**  
0 040 401 009

Marelli BKL 4A, 648 330 40  
 Marelli 9940095  
 Fiat DAB 800  
 Lucas

induktiv<sup>207</sup>  
5 Anschlüsse<sup>170</sup>

Autobianchi, Fiat

**ZM 014**  
0 040 401 014

Bosch 1 227 030 049  
 Bosch 940 038 507  
 Marelli 867 905 351  
 VW

Hall<sup>208</sup>  
6 Anschlüsse<sup>170</sup>

VW

**ZM 010**  
0 040 401 010

Lada 2108-03734-910-70,  
 Lada 2108-33734-910-10,  
 Lada 2108-37349-108-0,  
 Lada 2108-37349-108-9  
 Lucas DAB 953

Hall<sup>208</sup>  
7 Anschlüsse<sup>170</sup>

Lada

**ZM 015**  
0 040 401 015

Bosch 0 227 100 124,  
 Bosch 1 227 010 003,  
 Bosch 1 227 010 005,  
 Bosch 1 227 010 006  
 Citroën 96 048 807 080  
 Ford 86AB-12K064-AA  
 Opel 12 08 038, 12 08 243  
 Saab 402 3149

Endstufe<sup>123</sup>  
6 Anschlüsse<sup>170</sup>Citroën, Ford, Opel, Peugeot, Porsche,  
Saab, Seat**ZM 012**  
0 040 401 012

Bosch 0 227 100 142,  
 Bosch 0 227 100 143,  
 Bosch 0 227 100 147  
 Lucas DAB 402  
 VW 191 905 351, -A, -B, -C

Hall<sup>208</sup>  
7 Anschlüsse<sup>170</sup>

Audi, VW, Wartburg

**ZM 016**  
0 040 401 016

Delco Delco Remy D 1957, D 1961,  
 1977 958, 1979 107,  
 1979 571  
 AMC 898 350 1087  
 GM 1615 8829, 1641 0049  
 Isuzu 80 1979 5710  
 Opel 12 11 582, 12 11 591

induktiv<sup>207</sup>  
4+3 Anschlüsse<sup>170</sup>

Opel, Vauxhall

**ZM 013**  
0 040 401 013

Bosch 1 227 030 030  
 Bosch DAB 954  
 Lucas 867 905 352  
 VW 867 905 352  
 Seat

Endstufe<sup>123</sup>  
2+3 Anschlüsse<sup>170</sup>

Audi, Seat, VW

**ZM 017**  
0 040 401 017

Valeo CD 605, 73 502 602  
 Valeo 252 8001 A, 245 509  
 Ducellier 9942040  
 Fiat 940 038 518  
 Marelli DAB 202  
 Lucas

induktiv<sup>207</sup>  
2 Anschlüsse<sup>170</sup>

Fiat, Lancia

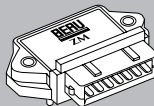

**ZM 018**  
0 040 401 018

Lucas  
Lucas DAB 126, 549 87 086  
GM 90243618, 90360315  
Opel 12 37 334, 12 37 464



Opel, Vauxhall

Endstufe<sup>123</sup>  
4 Anschlüsse<sup>170</sup>

**ZM 023**  
0 040 401 023

Nippon Denso  
Honda 30120-PM5-A01,  
06302-PT2-A00,  
06302-PT2-000  
Lucas DAJ 904  
NEC NEC-8132  
Ok! MINE-301/-302/-303,  
MC-8132



Acura (USA), Honda

induktiv<sup>207</sup>  
4 Anschlüsse<sup>170</sup>

**ZM 019**  
0 040 401 019

Ford  
Ford E5RF-12A297-BA,  
E43Z-12A297-A,  
1629456  
Lucas DAB 750  
Marelli 940 038 542  
Motorcraft EDY 7, DY 425



Ford

Hall<sup>208</sup>  
6+3 Anschlüsse<sup>170</sup>

**ZM 024**  
0 040 401 024

Mitsubishi  
Mitsubishi J 117, J007X00871  
Ford E 92Z-12A297-A  
Mazda F 829 18V20  
Motorcraft DYE 524, DYE 539,  
DYE 589



Ford, Mazda, Nissan

induktiv<sup>207</sup>  
4 Anschlüsse<sup>170</sup>

**ZM 020**  
0 040 401 020

Lucas  
Lucas DAB 118, DAB 127,  
DAB 129, DAB 135,  
84403  
Ford 6153380,  
84SF-12KO57-AA,  
84SF-12KO59-AA  
Marelli 940 038 544  
Rover RTC 5089



Ford, Morgan, Reliant, Rover

induktiv<sup>207</sup>  
2+3 Anschlüsse<sup>170</sup>

**ZM 025**  
0 040 401 025

Mitsubishi  
Mitsubishi J 120, J 170,  
J 170-9910A  
Mazda B541-18-V20



Ford, Mazda

induktiv<sup>207</sup>  
5 Anschlüsse<sup>170</sup>

**ZM 022**  
0 040 401 022

Mitsubishi  
Mitsubishi MD 607 364, DYE 923,  
J 106  
Chrysler MD 607478  
Lucas DAJ 204  
Mazda 8574-24-910,



Chrysler, Mazda, Mitsubishi

induktiv<sup>207</sup>  
4 Anschlüsse<sup>170</sup>

**ZM 026**  
0 040 401 026

Bosch  
Bosch 0 227 100 200  
BMW 1214 1461 441  
GM 90 44 650  
Opel 12 08 074



BMW Citroën, Fiat, Lancia, Opel,  
Peugeot, Porsche

Endstufe<sup>123</sup>  
7 Anschlüsse<sup>170</sup>

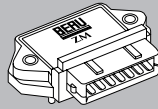

**ZM 027**  
0 040 401 027Hitachi  
Hitachi DIS4-05  
VW / Audi 4A0 905 351Endstufe<sup>123</sup>  
4+3 Anschlüsse<sup>170</sup>

Audi

**ZM 032**  
0 040 401 032Bosch  
Bosch 1 227 022 024  
GM 90273966  
Opel 12 08 247Endstufe<sup>123</sup>  
2+4 Anschlüsse<sup>170</sup>

Opel, Vauxhall

**ZM 028**  
0 040 401 028Hitachi  
Hitachi DIS4-08  
VW / Audi 8D0 905 351Endstufe<sup>123</sup>  
5+4 Anschlüsse<sup>170</sup>

Audi, VW

**ZM 034**  
0 040 401 034Bosch  
Bosch 1 227 022 028  
GM 90241775, 90296502,  
90297486, 90320586,  
90350987, 90279786,  
90297786  
Opel 12 08 040, 12 08 045,  
12 08 057, 12 37 306  
 Bosch 0 221 600 053,  
0 221 600 057,  
0 221 600 060Endstufe<sup>123</sup>  
2+4 Anschlüsse<sup>170</sup>

Opel

**ZM 029**  
0 040 401 029Bosch  
Lucas DAB 421  
Saab 7538796  
 Bosch 0 221 600 055Endstufe<sup>123</sup>  
2+4 Anschlüsse<sup>170</sup>

Saab

**ZM 036**  
0 040 401 036Bosch  
Bosch 1 227 022 034  
Renault 7401275174  
Volvo 1275174, 1367777,  
3507934  
 Bosch 0 221 601 005,  
0 221 601 012,  
0 221 601 452Endstufe<sup>123</sup>  
2+4 Anschlüsse<sup>170</sup>

Renault, Volvo

**ZM 031**  
0 040 401 031Bosch  
Hitachi CM1T204B,  
CM1T204D,  
CM1T204E  
VW / Audi 440 905 105,  
443 905 105 BEndstufe<sup>123</sup>  
2+3 Anschlüsse<sup>170</sup>

Audi

**ZM 038**  
0 040 401 038Bosch  
BMW 12 14 1 287 757,  
12 14 1 705 607,  
12 14 1 705 608,  
12 14 1 706 439  
Siemens 6116, 5WK6  
Telefunken 337179induktiv<sup>207</sup>  
2+5 Anschlüsse<sup>170</sup>

BMW

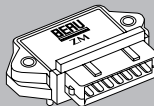

**ZM 039**

0 040 401 039

Bosch  
 Bosch 0 227 100 120  
 Lada/ 363734,  
 Shiguli 2108373491010  
 Volvo/DAF 285230, 3501922



Lada, Volvo

Hall<sup>208</sup>  
 7 Anschlüsse<sup>170</sup>

**ZM 045**

0 040 401 045

Hitachi  
 Hitachi E12302, E12303  
 Honda 30130-P06-006



Honda

induktiv<sup>207</sup>  
 4 Anschlüsse<sup>170</sup>

**ZM 040**

0 040 401 040

Bosch  
 Bosch 0 227 100 145  
 Fiat/Lancia 7612955, 9612955  
 Volvo 3501921, 3501921-5



Lancia, Volvo

Endstufe<sup>123</sup>  
 6 Anschlüsse<sup>170</sup>

**ZM 046**

0 040 401 046

Hitachi  
 GM 94243344  
 Hitachi E1261, E1288  
 Honda 30120-PA0-661,  
 30120-PH4-005,  
 32120-PA0-661  
 Isuzu 8942433440  
 Lucas DAJ 106  
 Nissan 22020-15M00,  
 22020-15M20,  
 22020-P4005  
 Subaru 49146-7401

Subaru



induktiv<sup>207</sup>  
 2 Anschlüsse<sup>170</sup>

**ZM 041**

0 040 401 041

Lucas  
 Lucas DAB 126, DAB 134,  
 80334 A, 8490 D  
 GM 90360314, 90360315,  
 90243618, 90243630  
 Opel 12 37 334, 12 37 464,  
 62 37 777  
 Siemens 5 WKG 6208,  
 5 WKG 222



Opel, Vauxhall

Endstufe<sup>123</sup>  
 4 Anschlüsse<sup>170</sup>

**ZM 047**

0 040 401 047

Lucas  
 Lucas 54 896, 80 428, 84  
 193, 84 453, 84 453B,  
 84 504B, 84 567,  
 84 567B, 84 896,  
 DAB 119, DAB 120,  
 DAB 121, DAB 127,  
 DAB 135  
 Rover BAU5100, BAU5538,  
 RTC5089

Rover



Aston Martin, Ford, Rover, TVR

induktiv<sup>207</sup>  
 2 Anschlüsse<sup>170</sup>

**ZM 043**

0 040 401 043

Delco  
 Delco 1798617, 1976908,  
 1977907, 1987744,  
 D1948, D1952,  
 D1956, D1963A  
 Ford E2FS12A297B,  
 ESFZ12Z297  
 GM 1976908, 1977907,  
 1978617, 1987744  
 Opel 16 05 130



Cadillac (USA), Fiat, Chevrolet (USA),  
 GMC (USA), Oldmobile (USA), Pontiac  
 (USA)

induktiv<sup>207</sup>  
 2+5 Anschlüsse<sup>170</sup>

**ZM 048**

0 040 401 048

Lucas  
 Lucas 84987, 84988,  
 DAB 132, DAB 133  
 Ford F3XY12D 072A  
 Nissan 22020-0B000,  
 22020-53J120,  
 22020-55Y00,  
 22020-53J10,  
 22020-53J20,  
 22020-56E11,  
 22020-56E16,  
 22020-56E17,  
 22020-70J00,  
 22020-71J00,  
 PRW1A, PRW2,  
 PRW2A, PRW3

Nissan

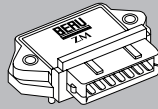

Endstufe<sup>123</sup>  
 3 Anschlüsse<sup>170</sup>

**ZM 049**  
0 040 401 049

Mitsubishi  
Bosch 9 222 067 034  
Chrysler MD112479,  
MD164475  
Hyundai 27360-32800,  
96056317, 96067829  
Mitsubishi 112955, 132243,  
2371771, J007X00971,  
J007X01271,  
J009T02071, J121,  
MD112479, MD129550,  
MD1312243,  
MD164475, MD611384,  
MD618268

induktiv<sup>207</sup>  
3 Anschlüsse<sup>170</sup>

Hyundai, Mitsubishi

**ZM 053**  
0 040 401 053

Mitsubishi  
Chrysler MD607814,  
MD611384  
Hyundai 27120-21020,  
27120-21050  
Mazda AM15-18-V20,  
E730-12-491 0  
Mitsubishi EJN902, J152,  
MD607814,  
MD611384

induktiv<sup>207</sup>  
2 Anschlüsse<sup>170</sup>

Daihatsu, Hyundai, Mitsubishi

**ZM 050**  
0 040 401 050

Mitsubishi  
Ford F0BZ12A297A  
Mazda BP01-18-251  
Mitsubishi J701

induktiv<sup>207</sup>  
3 Anschlüsse<sup>170</sup>

Mazda

**ZM 054**  
0 040 401 054

Nippon Denso  
Austin-Rover BNP 3661, CKP 7061  
Honda 30550-689-003,  
30550-692-004,  
30550-692-014,  
30550-692-2014

induktiv<sup>207</sup>  
5 Anschlüsse<sup>170</sup>

Honda, Triumph

**ZM 051**  
0 040 401 051

Mitsubishi  
Mitsubishi MD618293, J153

induktiv<sup>207</sup>  
4 Anschlüsse<sup>170</sup>

Mitsubishi

**ZM 055**  
0 040 401 055

Nippon Denso  
Honda 30550-PH3 004

induktiv<sup>207</sup>  
5 Anschlüsse<sup>170</sup>

Honda

**ZM 052**  
0 040 401 052

Mitsubishi  
Mitsubishi 5201A, J007X03471,  
J304  
Nissan 22020-D0210

induktiv<sup>207</sup>  
6 Anschlüsse<sup>170</sup>

Nissan (USA), Renault

**ZM 056**  
0 040 401 056

Nippon Denso  
Honda 30120-PA6-921,  
30120-PB1-006,  
30120-PH7-006,  
30120-PJ7-003

induktiv<sup>207</sup>  
4 Anschlüsse<sup>170</sup>

Honda

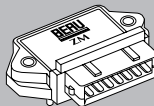

**ZM 057**

0 040 401 057

Nippon Denso  
GM 9404544  
Isuzu 8944045440  
Mitsubishi CY-GS 065 A  
Nippon Denso 131300-0033,  
131300-0072,  
131300-033,  
131300-0330  
Toyota 89620-10090,  
89620-10120,  
89620-12340,  
89620-16070,  
CY-GS 065 A



induktiv<sup>207</sup>  
2+2 Anschlüsse<sup>170</sup>

Toyota

**ZM 061**

0 040 401 061

Marelli  
Lucas DAB 801  
Magneti Marelli 64833031, 64833036,  
940038535,  
64833031010,  
64833036010,  
581701010000,  
581701020000,  
BKL3B, BKL 3BD



Endstufe<sup>123</sup>  
6 (7) Anschlüsse<sup>170</sup>

Ferrari, Fiat, Lancia

**ZM 058**

0 040 401 058

Nippon Denso  
GM 94840126  
Nippon Denso 131000-0511,  
131000-0920,  
131000-511, 131000-  
920, 131300-0511,  
131300-0920  
Toyota 16080-12320, 78512-  
12310, 89612-12310,  
89612-12320, 89612-  
16080, 89620-12290,  
89620-12310, 89620-  
12320, 89620-16080,  
89620-26080



induktiv<sup>207</sup>  
2+2 Anschlüsse<sup>170</sup>

Toyota

**ZM 062**

0 040 401 062

Bosch  
Bosch 0 227 100 211  
Ford 98 VW12A223AA  
VW/Audi 4D0905351



Endstufe<sup>123</sup>  
5+4 Anschlüsse<sup>170</sup>

Audi, Seat, Skoda, VW

**ZM 059**

0 040 401 059

Nippon Denso  
Hitachi L130-5046  
Honda 30120-PA-921  
Nippon Denso 131000-0011,  
131300-0011,  
131300-0120,  
131300-0121  
Toyota 89620-14210,  
89620-32020,  
L1305046



induktiv<sup>207</sup>  
3+2 Anschlüsse<sup>170</sup>

Toyota

**ZM 063**

0 040 401 063

Bosch  
Bosch 0 227 100 209,  
0 227 100 210  
VW/Audi 4A0905351A



Endstufe<sup>123</sup>  
4+3 Anschlüsse<sup>170</sup>

Audi

**ZM 060**

0 040 401 060

Lada  
Magneton-Pal TZP 443 213 221 020  
Skoda 115915080  
VW/Audi 115 915 080



induktiv<sup>207</sup>  
4 Anschlüsse<sup>170</sup>

Skoda



Original BERU Markenprodukte werden nach strengsten Qualitätsvorgaben hergestellt. Um eine einwandfreie Funktion zu gewährleisten, beachten Sie bitte folgende Montagehinweise.

Original BERU Brand Products are Manufactured in Compliance with strict quality-control requirements. Please heed the following mounting instructions to ensure proper functioning of the products.

Les produits d'origine de marque BERU sont fabriqués selon des directives de qualité les plus sévères. Veuillez observer les instructions de montage suivantes, pour garantir un fonctionnement impeccable.

## Steckerzündspulen

Mit der Zündspule sollte grundsätzlich auch der Zündkerzenstecker ersetzt werden. Durch Laufzeit und Alterung ist der Zündkerzenstecker meistens im Dichtbereich der Zündkerze versprödet und deshalb undicht – das kann zu Zündaussetzern führen.

1. Zündung abschalten  
Vor dem Ausbau der Zündspule 15 Minuten warten. Damit werden Spannungsspitzen die zur Zerstörung von Steuergeräten führen können, vermieden
2. Defekte Zündspule ausbauen
3. Zündkerzenhals oder Innenteil des Steckers dünn mit dem BERU Zündkerzen Steckerfett (Bestell-Nr. 0 890 300 029) bestreichen
4. Zündkerzenstecker auf die Zündspule stecken
5. Zündspule mit Stecker auf die Zündkerze montieren. Zündspule festschrauben. (Anzugsdrehmoment beachten)
6. Kontakte des Primärstecker auf Oxidation überprüfen und ggf. reinigen

## Plug top Coils

Due to operating time and aging, the spark plug connector becomes brittle and thus untight in the sealing area of the spark plug, which may cause misfiring.

1. Switch off the ignition  
Wait for 15 min before demounting the ignition coil. This prevents voltage peaks that could destroy control devices.
2. Remove the defective coil
3. Apply a thin film of BERU spark plug connector grease (order no. 0 890 300 029) to the neck of the spark plug or the inner part of the socket.
4. Attach the spark plug connector to the coil
5. Mount the coil with the connector on the spark plug (heed the tightening torque)
6. Check the primary connector contacts for oxidation and clean it, if required

## Bobines D'allumages enfichables

De façon générale, la cosse de la bougie devrait être remplacée en même temps que la bobine d'allumage. Avec le temps et en raison du vieillissement, la cosse de la bougie est en général fragilisée au niveau de la zone d'étanchéité et n'est donc plus étanche – ceci peut entraîner des ratés d'allumage.

1. Coupez l'allumage  
Attendez 15 minutes avant de démonter la bobine d'allumage. Ceci permet d'éviter les crêtes de tension qui pourraient entraîner la destruction des boîtiers électroniques de commande.
2. Démontez la bobine d'allumage défectueuse
3. Enduisez légèrement la tête de la bougie ou la partie intérieure de la cosse avec la graisse BERU pour cosses de bougies (numéro de commande 0 890 300 029)
4. Emboîtez la cosse de la bougie sur la bobine d'allumage
5. Montez la bobine d'allumage avec la cosse sur la bougie (respectez le couple de serrage)
6. Vérifiez la présence d'agents oxydants sur les contacts de la cosse primaire et, le cas échéant, nettoyez-les

Originele BERU merkproducten worden volgens zeer strenge kwaliteitseisen vervaardigd. Om een correcte functie te garanderen, dient u op de volgende montageaanwijzingen te letten.

Los productos originales de la marca BERU se fabrican según las normas más estrictas de calidad. Para garantizar un funcionamiento impecable, observe las siguientes indicaciones para el montaje.

I prodotti originali di marca BERU vengono realizzati secondo i più severi criteri di qualità. Al fine di poter garantire una funzione perfetta, si prega di osservare le seguenti istruzioni per il montaggio.

## Stekkerbobines

Met de bobine moet principieel ook de bougiestekker worden vervangen. Door de looptijd en veroudering is de bougiestekker meestal broos geworden in het afdichtingsgebied van de bougie en daarom on dicht. Dit kan leiden tot uitvallen van de ontsteking.

1. Ontsteking uitschakelen  
Wacht 15 minuten voor de demontage van de bobine. Daardoor worden spanningspieken voorkomen die de besturingsapparaten zouden kunnen vernielen
2. Defecte bobine demonteren
3. Hals van de bougie of inwendig gedeelte van de stekker dun insmeren met BERU bougiestekkervet (bestelnummer 0 890 300 029)
4. Bougiestekker op de bobine steken
5. Bobine met stekker op de bougie monteren. Bobine vastschroeven. (Let op aandraaikoppel)
6. Contacten van de primaire stekker op oxidatie controleren en evt. reinigen

## Bobinas de encendido con conector

Junto a la bobina de encendido, también se debería cambiar, de forma general, el conector de bujías. Debido al tiempo de funcionamiento y al envejecimiento, el conector de bujías casi siempre está quebradizo en la zona de junta de la bujía y, por lo tanto, ya no es estanco; esto puede dar lugar a fallos de encendido.

1. Apague el motor  
Antes de desmontar la bobina de encendido, espere 15 minutos. De esta forma se evitan puntas de tensión que pueden conducir a la destrucción de las unidades de control
2. Desmonte la bobina de encendido defectuosa
3. Aplique una fina capa de grasa para conectores de bujías de BERU (nº de pedido 0 890 300 029) sobre el cuello de la bujía o sobre la parte interior del conector
4. Enchufe el conector de bujías en la bobina de encendido
5. Monte la bobina de encendido con el conector en la bujía de encendido (observe el par de apriete)
6. Compruebe los contactos del conector primario con respecto a oxidación y límpielos si es necesario

## Bobine d'accensione a Spina

In linea di massima insieme alla bobina d'accensione si dovrebbero sostituire anche i cappucci delle candele d'accensione. Dopo una lunga durata e in-vecchiamento, i cappucci delle candele d'accensione nella maggior parte dei casi sono screpolati e di conseguenza non ermetici – ciò può causare difficoltà d'avviamento.

1. Disinserire l'accensione  
Prima di smontare la bobina attendere almeno 15 minuti. In tal modo si preven gono picchi di tensione, che possono avere la conseguenza di una distruzione delle unità di controllo
2. Smontare la bobina d'accensione difettosa
3. Ingrassare successivamente l'isolante ceramico della candela oppure la parte interna del cappuccio con uno strato sottile di grasso BERU (codice no. 0 890 300 029)
4. Inserire il cappuccio della candela sulla bobina d'accensione
5. Montare la bobina d'accensione completa di cappuccio sulla candela (rispettare la coppia di serraggio)
6. Controllare i contatti dell'avvolgimento primario per la presenza di ossidazione e pulirli all'occorrenza

Оригинальные фирменные компоненты BERU изготавливаются согласно жестким нормам качества. Чтобы обеспечить исправную работу, монтаж должен быть выполнен в соответствии со следующими указаниями.

Oryginalne markowe produkty BERU są produkowane zgodnie z surowymi standardami jakości. Aby zagwarantować sprawne działanie należy przestrzegać następujących zasad montażu.

Τα αυθεντικά επώνυμα προϊόντα BERU έχουν κατασκευαστεί με τις πιο αυστηρές προδιαγραφές ποιότητας. Για να διασφαλιστεί η απρόσκοπτη λειτουργία, παρακαλούμε προσέξτε τις παρακάτω υποδείξεις συναρμολόγησης.

## Штекерные катушки зажигания

Вместе с катушкой зажигания обязательно заменить также штекер свечи зажигания. В результате эксплуатации и старения штекер свечи зажигания, как правило, в зоне уплотнения свечи зажигания становятся хрупкими с потерей герметичности, что может стать причиной перебоев в зажигании.

1. Выключить зажигание  
Перед демонтажом катушки зажигания выждать 15 минут. Это позволяет предотвратить пики напряжения, которые могут стать причиной повреждения устройств управления
2. Демонтировать дефектную катушку зажигания
3. Покрыть шейку свечи зажигания или внутреннюю часть штекера тонким слоем смазки для штекеров свечей зажигания BERU (№ заказа 0 890 300 029)
4. Вставить штекер свечи зажигания в катушку зажигания
5. Смонтировать катушку зажигания с штекером на свече зажигания. Плотно привинтить катушку зажигания. (Обеспечить нужный крутящий момент затяжки)
6. Проверить контакты штекера первичного контура на наличие окислов и при необходимости очистить

## Wtykowe cewki zapłonowe

Wraz z cewką zapłonową należy wymieniać również wtyczkę świecy zapłonowej. Wraz z czasem eksploatacji w wyniku procesu starzenia wtyczka świecy zapłonowej w obszarze uszczelniania świecy kruszeje i traci szczelność, co może powodować brak iskry.

1. Wyłączyć zapłon  
Przed demontażem cewki zapłonowej odczekać 15 minut. Uniknie się dzięki temu szczytowych napięć, które mogłyby uszkodzić sterowniki
2. Wymontować uszkodzoną cewkę zapłonową
3. Szyjkę świecy zapłonowej lub wewnętrzną część wtyczki posmarować cienką warstwą smaru do wtyczek świec zapłonowych BERU (nr katalogowy 0 890 300 029).
4. Wtyczkę świecy zapłonowej podłączyć do cewki zapłonowej
5. Cewkę zapłonową z wtyczką zamontować na świecy zapłonowej. Dokręcić cewkę zapłonową. (przestrzegać wymaganego momentu dokręcenia)
6. Sprawdzić styki wtyczki uzwojenia pierwotnego, czy nie są utlenione i w razie potrzeby wyczyścić

## Πηνία ανάφλεξης με συνδετήρα

Μαζί με το πηνίο ανάφλεξης θα πρέπει να αντικαθίσταται και ο συνδετήρας μπουζί. Λόγω χρήσης και παλαιώσης, ο συνδετήρας μπουζί συνήθως είναι εύθραυστος στην περιοχή στεγανοποίησης του μπουζί και έτσι μη στεγανός – αυτό μπορεί να οδηγήσει σε αποτυχιές ανάφλεξης.

1. Απενεργοποιήστε την ανάφλεξη  
Πριν από την αφαίρεση του πηνίου ανάφλεξης, περιμένετε 15 λεπτά. Έτσι αποφεύγονται οι αιχμές τάσης, που θα μπορούσαν να οδηγήσουν σε καταστροφή των μονάδων ελέγχου
2. Αφαιρέστε το ελαττωματικό πηνίο ανάφλεξης
3. Επαλείψτε την πίπα του μπουζί ή το εσωτερικό τμήμα του συνδετήρα με λεπτή στρώση λιπαντικού για πίπα μπουζί BERU (κωδ. παραγγελίας 0 890 300 029)
4. Τοποθετήστε το συνδετήρα μπουζί πάνω στο πηνίο ανάφλεξης
5. Συναρμολογήστε το πηνίο ανάφλεξης με το συνδετήρα πάνω στο μπουζί. Βιδώστε το πηνίο ανάφλεξης. (προσέξτε τη ροπή σύσφιξης)
6. Ελέγξτε τις επαφές του κύριου συνδετήρα για οξειδωση και αν χρειαστεί καθαρίστε τις



Az eredeti BERU márkájú termékek gyártása a legszigorúbb minőségi előírások szerint történik. A kifogástalan működés biztosítása érdekében kérjük, vegye figyelembe a következő szerelési tudnivalókat.

Os produtos da marca Beru originais são fabricados sob os mais rígidos requisitos de qualidade. Respeite as seguintes indicações de montagem para garantir um funcionamento sem problemas.

Orijinal BERU markalı ürünler en sıkı kalite spesifikasyonlarına göre üretilir. Kusursuz bir çalışmayı garanti etmek için lütfen aşağıdaki montaj bilgilerine dikkat ediniz.

### Dugaszos gyújtótekercek

A gyújtótekerccsel együtt mindig ki kell cserélni a gyújtógyertya dugaszt is. A használati idő és az öregedés miatt a gyújtógyertya tömítési tartományában legtöbbször rideggé válik a gyújtógyertya dugasz és ezért nem tömít megfelelően - ez pedig gyújtáskihagyáshoz vezethet.

1. Kapcsolja le a gyújtást.  
A gyújtótekercs kiszérése előtt várjon 15 percet. Ezzel elkerülhetők azok a feszültségcsúcsok, amelyek a vezérlőkészülékek tönkretételéhez vezethetnek.
2. Szerelje ki a hibás gyújtótekercsset.
3. Kenje be vékonyan a gyújtógyertya nyakát vagy a dugasz belső részét BERU gyújtógyertyadugasz-zsírral (megrendelési szám: 0 890 300 029).
4. Dugja rá a gyújtógyertya dugaszt a gyújtótekercsre.
5. Szerelje rá a dugasszal a gyújtótekercsset a gyújtógyertyára. Csavarja helyére szorosán a gyújtótekercsset. (Ügyeljen a meghúzási nyomatékra.)
6. Ellenőrizze a primer dugasz érintkezőit oxidálódás szempontjából és szükség esetén tisztítsa meg őket.

### Bobina de ignição de encaixe

Por princípio, o conector da vela de ignição deve ser substituído juntamente com a bobina de ignição. O conector da vela de ignição fica fragilizado com o tempo de funcionamento e o envelhecimento, principalmente na área da junta da vela, ficando por isso com fugas, podendo originar falhas.

1. Desligar a ignição  
Aguardar 15 minutos antes da desmontagem da bobina. Dessa forma, evitam-se os picos de tensão que podem originar danos nas unidades de comando
2. Desmontar a bobina de ignição avariada
3. Aplicar uma camada fina de massa para conectores de velas de ignição (n.º de encomenda: 0 890 300 029) na haste da vela de ignição ou no interior do conector
4. Colocar o conector da vela de ignição na bobina de ignição
5. Montar a bobina de ignição com o conector na vela de ignição (tenha atenção ao binário de aperto)
6. Verificar os contactos do conector primário quanto a oxidação e, se necessário, limpar

### Soketli atesleme bobinleri

Prensip olarak, atesleme bobiniyle birlikte buji soketi de deęistirilmelidir. Çalışma süresi ve eskime nedeniyle, buji soketi genellikle bujinin sızdırmazlık bölgesinde gevrekleşir ve bunun sonucunda sızdırmazlık özelliğini kaybeder - bu, atesleme kesikliğine neden olabilir.

1. Kontakı kapatınız  
Atesleme bobinini sökmeden önce 15 dakika bekleyiniz. Bu sayede, kontrol ünitelerinin zarar görmesine neden olan uç gerilimler önlenir
2. Arızalı atesleme bobinini sökünüz
3. Buji boynu ve soketin iç parçasına ince bir tabaka BERU buji soket gresi (Sipariş No. 0 890 300 029) sürünüz
4. Buji soketini atesleme bobinine takınız
5. Atesleme bobinini soketle birlikte bujiye takınız. Atesleme bobinini vidalayınız. (Sıkma torkuna dikkat ediniz)
6. Birincil devre soketinin kontaklarını oksitlenme açısından kontrol ediniz ve gerekirse deęistiriniz



**ZS 014**  
0 040 100 014

BMW 12 13 1 731 134 B,  
1 726 176, 1 730 765,  
1 731 134B  
Bosch 0 221 504 410

BMW ( M 42..., M50..., M60... )  
 **ZLE 232** - 0 300 122 115 (2 kΩ)



**ZS 030**  
0 040 100 030

BMW 12 13 2 346 570

BMW F 650 GS  
 **ZSH 001** - 2 040 821 011  
 **ZE 115** - 0300 811 720



**ZS 016**  
0 040 100 016

Audi/VW 058 905 101,  
058 905 105

Audi A3/A4/A6, Volkswagen  
 **ZLE 276** - 0 300 122 117 (2 kΩ)



**ZS 031**  
0 040 100 031

Porsche 996 602 102 00,  
996 602 101 01

Porsche Boxster/Carrera - M 96...  
 **ZLE 278** - 0 300 122 119 (2 kΩ)



**ZS 017**  
0 040 100 017

Audi 077 905 104,  
058 905 105

Audi (A8)  
 **ZLE 277** - 0 300 122 118 (2 kΩ)



**ZS 036**  
0 040 100 036

Porsche 996 602 104 00

Porsche 911 3.6 Carrera/GT 3, Cayman  
 M 96.03/70/76/79  
 **ZLE 255** - 0 300 122 114 (2 kΩ)



**ZS 029**  
0 040 100 029

Fiat/Lancia 46 480 361, 77 893 46

Fiat, Lancia



**ZS 037**  
0 040 100 037

VW 071 905 106

Volkswagen Golf/Passat/Transporter





**ZS 041**

0 040 100 041

Bosch 0 986 221 007  
Mercedes Benz A 000 150 17 80,  
A 000 150 28 80

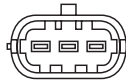

Mercedes Benz C/SLK

**GS 17** - 0 010 020 022

**ZS 053**

0 040 100 053

Mercedes Benz A 000 150 15 80

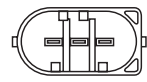

Mercedes Benz C/E (M 271...)

**GS 21** - 0 010 020 021

**ZS 043**

0 040 100 043

Audi 034 905 101,  
034 905 105



Audi

**ZLE 233** - 0 300 122 116 (5 kΩ)

**ZS 054**

0 040 100 054

Ducati 38040081 A,  
38040082 A

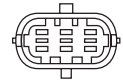

Ducati Superbike 749S, 999/S/R

2 x **ZS 054**

**ZS 049**

0 040 100 049

Perkins 4173 D 004

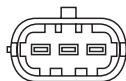

Perkins-Gasmotoren<sup>51</sup> 900/1000-Serie  
(Gabelstapler<sup>52</sup>)

**ZS 056**

0 040 100 056

Ducati 38040101 C



Ducati Multistrada 1000DS

2 x **ZS 056**

**ZS 052**

0 040 100 052

nur paarweise tauschen<sup>282</sup>

Renault 77 00 107 177,  
77 00 113 357,  
77 00 113 A,  
77 00 875 000,  
82 00 208 611



Renault

**GS 29** - 0 010 020 029

**ZS 068**

0 040 100 068

Land Rover NEC 000070 L  
Rover NEC 000110 L

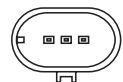

Land Rover, MG, Rover



**ZS 077**  
0 040 100 077

Mercedes A 000 150 25 80

Mercedes C/E/SLK (M 271...)

**GS 21** - 0 010 020 021

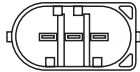

**ZS 088**  
0 040 100 088

Rover NEC 000070, 000110

MG, Rover

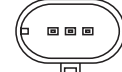

**ZS 078**  
0 040 100 078

Piaggio 828817, BD.0081419.A  
58120R, BD.0014694.A

Vespa 250 GTS/06.2005



**ZS 090**  
0 040 100 090

Fiat 55 231 256, 55 234 131

Alfa Romeo, Fiat (Twin Air Turbo 0,9)

**GS 21** - 0 010 020 051



**ZS 079**  
0 040 100 079

Fiat 55208723, 55200112,  
55200486

Fiat, Lancia



**ZS 095**  
0 040 100 095

Fiat 55209603, 55213613,  
55224494

Anschlußtechnik Kontaktfeder



**ZS 085**  
0 040 100 085

Ducati 38010143 A,  
38010143 B,  
38010145 B

2 x **ZS 085**   
Steckerfarbe grau<sup>118</sup>

Ducati 749S, 999/-S/-R (2003-)  
Ducati 1098S (2007-)  
Nur in Verbindung mit NGK  
MAR10A-J

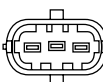

**ZS 096**  
0 040 100 096

Chrysler 00K 68081914 AA,  
00K 68081914 AB  
68081914 AA  
68081914 AB  
Fiat 68081914 AA  
68081914 AB

Anschlußtechnik Kontaktfeder



**ZS 105** ersetzt<sup>1263</sup> ZS 101 –  
0 040 100 105 0 040 100 101Ø 55 mm  
↑ 150 mm

Bosch 0 221 124 001, K 6V

**6 Volt, max. 26 kV**  
ohne Startspannungsanhebung<sup>127</sup>Hochleistungs-Zündspule, blau<sup>133</sup>Nach DIN 72531, mit internationaler  
Befestigungsschelle<sup>162</sup>Fahrzeuge mit 2, 3, 4, 5, 6, 8-Zyl.-Motor,  
Züandanlage ohne Vorwiderstand<sup>174</sup>**ZS 115**  
0 040 100 115Ø 55 mm  
↑ 150 mmBosch 0 221 119 016,  
0 221 119 021**12 Volt, max. 33,5 kV**  
Startspannungsanhebung möglich<sup>129</sup>Hochleistungs-Zündspule, schwarz<sup>138</sup>Nach DIN 72531, mit internationaler  
Befestigungsschelle<sup>162</sup>Fahrzeuge mit 4, 6-Zyl.-Motor,  
0,9 Ω Widerstand WZ 09-2/0 110 510 008  
vorschalten oder Widerstandsleitung 0,9 Ω  
verwenden  
(Serie oder nachrüsten)<sup>181</sup>**ZS 106** ersetzt<sup>263</sup> ZS 102 –  
0 040 100 106 0 040 100 102Ø 55 mm  
↑ 150 mm

Bosch 0 221 119 027, K 12V

**12 Volt, max. 31 kV**  
ohne Startspannungsanhebung<sup>127</sup>Hochleistungs-Zündspule, blau<sup>134</sup>Nach DIN 72531, mit internationaler  
Befestigungsschelle<sup>162</sup>Fahrzeuge mit 2, 3, 4, 5, 6, 8-Zyl.-Motor,  
Züandanlage ohne Vorwiderstand<sup>174</sup>**ZS 117**  
0 040 100 117Ø 60 mm  
↑ 150 mmBosch 0 221 118 307  
Mercedes Benz A 000 158 40 03**12 Volt, max. 30 kV**  
ohne Startspannungsanhebung<sup>127</sup>Zündspule für Transistor-Züandanlage<sup>55</sup>  
(Etikett gelb<sup>53</sup>)Nach DIN 72531, mit internationaler  
Befestigungsschelle<sup>162</sup>

Mercedes Benz (Typ 123/124/201/...)

**ZS 109**  
0 040 100 109Ø 55 mm  
↑ 150 mmBosch 0 221 119 030,  
KW 12V**12 Volt, max. 33 kV**  
Startspannungsanhebung möglich<sup>129</sup>Resistor-Hochleistungs-Zündspule,  
orange<sup>135</sup>Nach DIN 72531, mit internationaler  
Befestigungsschelle<sup>162</sup>Fahrzeuge mit 4, 5, 6, 8-Zyl.-Motor,  
1,8 Ω Widerstand WZ 18-2/0 110 520 001  
vorschalten oder Widerstandsleitung 1,8 Ω  
verwenden (Serie oder nachrüsten)<sup>176</sup>**ZS 118**  
0 040 100 118Ø 60 mm  
↑ 150 mmBosch 0 221 118 329  
Mercedes Benz A 000 158 45 03**12 Volt, max. 30 kV**  
ohne Startspannungsanhebung<sup>127</sup>Zündspule für Transistor-Züandanlage<sup>55</sup>  
(Etikett grün<sup>54</sup>)Nach DIN 72531, mit internationaler  
Befestigungsschelle<sup>162</sup>

Mercedes Benz (Typ 107/126)

**ZS 110**  
0 040 100 110Ø 55 mm  
↑ 150 mm

Bosch 0 221 119 031

**12 Volt, max. 33 kV**  
mit Startspannungsanhebung<sup>128</sup>Resistor-Hochleistungs-Zündspule,  
orange<sup>135</sup>Nach DIN 72531, mit internationaler  
Befestigungsschelle<sup>162</sup>Fahrzeuge mit 4, 5, 6, 8-Zyl.-Motor,  
1,8 Ω Vorschaltwiderstand  
WZ 18-2/0 110 520 001 (beigepackt)  
zur Nachrüstung, dadurch Kaltstart-  
verbesserung<sup>177</sup>**ZS 119**  
0 040 100 119Ø 60 mm  
↑ 156 mmBosch 0 221 118 351  
Lancia 71716152  
Volvo 1346071**12 Volt**ohne Startspannungsanhebung<sup>127</sup>Zündspule (schwarz)<sup>133</sup>ohne Befestigungsschelle<sup>180</sup>

Peugeot, Lancia, Volvo





**ZS 120**  
0 040 100 120

Bosch 0 221 122 334  
VW/Audi 000 395 308 1,  
035 905 105 A  
Volvo 1317810, 1317815,  
9438228

**12 Volt**  
ohne Startspannungsanhebung<sup>127</sup>

Zündspule (schwarz)<sup>133</sup> für elektron.  
Zündanlage<sup>201</sup>

Nach DIN 72531, mit internationaler  
Befestigungsschelle<sup>162</sup>

Audi/VW/Seat, Lada, Volvo



Ø 55 mm  
↓ 151 mm



**ZS 124**  
0 040 100 124

Bosch 0 221 122 349  
VW 191 905 115,  
211 905 115D

**12 Volt**  
ohne Startspannungsanhebung<sup>127</sup>

Zündspule für Transistor-Zündanlage<sup>55</sup>  
(Etikett grün<sup>54</sup>)

Nach DIN 72531, mit internationaler  
Befestigungsschelle<sup>162</sup>

Audi/VW/Seat, Wartburg



Ø 55 mm  
↓ 146 mm

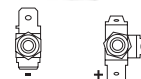

**ZS 121**  
0 040 100 121

Bosch 0 221 122 327  
Saab 8573834, 9573834

**12 Volt**  
ohne Startspannungsanhebung<sup>127</sup>

Zündspule (schwarz)<sup>133</sup>

ohne Befestigungsschelle<sup>180</sup>

Saab



Ø 55 mm  
↓ 146 mm



**ZS 125**  
0 040 100 125

Bosch 0 221 122 402,  
0 221 122 403,  
1 227 020 029  
GM/Opel 1208047  
90348296

**12 Volt**  
ohne Startspannungsanhebung<sup>127</sup>

Zündspule für Transistor-Zündanlage<sup>55</sup>  
(Etikett gelb<sup>53</sup>)

Nach DIN 72531, mit internationaler  
Befestigungsschelle<sup>162</sup>

Opel, Vauxhall



Ø 55 mm  
↓ 146 mm



**ZS 122**  
0 040 100 122

Bosch 0 221 118 335,  
0 221 118 442  
BMW 12 13 1 286 087

**12 Volt**  
ohne Startspannungsanhebung<sup>127</sup>

Zündspule für Transistor-Zündanlage<sup>55</sup>  
(Etikett gelb<sup>53</sup>)

ohne Befestigungsschelle<sup>180</sup>

Alfa Romeo, BMW, Porsche



Ø 60 mm  
↓ 149 mm



**ZS 126**  
0 040 100 126

Bosch 0 221 122 362,  
0 221 122 450  
Ford 1027286  
92GB12024AA  
Jaguar FOR6077429

**12 Volt**  
ohne Startspannungsanhebung<sup>127</sup>

Zündspule für Transistor-Zündanlage<sup>55</sup>  
(Etikett rot<sup>58</sup>)

Nach DIN 72531, mit internationaler  
Befestigungsschelle<sup>162</sup>

Ford, Jaguar



Ø 55 mm  
↓ 141 mm



**ZS 123**  
0 040 100 123

Bosch 0 221 122 399,  
0 221 122 418,  
0 221 600 011  
VW 191 905 115A

**12 Volt**  
ohne Startspannungsanhebung<sup>127</sup>

Zündspule für Transistor-Zündanlage<sup>55</sup>  
(Etikett grau<sup>57</sup>)

Nach DIN 72531, mit internationaler  
Befestigungsschelle<sup>162</sup>

VW



Ø 55 mm  
↓ 146 mm



**ZS 127**  
0 040 100 127

Bosch 0 221 122 408,  
0 221 122 409,  
F 000 ZS0 001  
GM/Opel 1208053, 90350021  
Saab 4226031, 5171111

**12 Volt**  
ohne Startspannungsanhebung<sup>127</sup>

Zündspule für Transistor-Zündanlage<sup>55</sup>  
(Etikett gelb<sup>53</sup>)

Nach DIN 72531, mit internationaler  
Befestigungsschelle<sup>162</sup>

Opel, Saab, Vauxhall



Ø 55 mm  
↓ 148,5 mm



**ZS 210**  
0 040 100 210Ø 40 mm  
↓ 115 mm

Bosch 0 222 001 002, J 3V

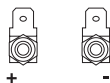
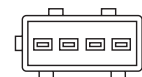
**3 Volt, max. 20 kV**  
silber<sup>136</sup>ohne Befestigungsschelle<sup>180</sup>für 2-Zyl.-Motor u. 6-Volt-Batterie  
(2 Zündspulen primärseitig hintereinander  
geschaltet)<sup>182</sup> **ZS 230**  
0 040 100 230Bosch 0 221 503 417  
Alfa Romeo 605 641 42  
Fiat 6 080 8059

Alfa Romeo V6, Fiat V6, Lancia V6

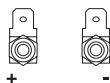
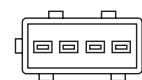
**ZS 215**  
0 040 100 215Ø 40 mm  
↓ 115 mmBosch 0 222 002 002,  
0 222 002 004, J 6V**6 Volt, max. 18 kV**  
silber<sup>136</sup>ohne Befestigungsschelle<sup>180</sup>für 1-, 2-Zylinder-Motoren<sup>125</sup>, **ZS 231**  
0 040 100 231Bosch 0 221 503 003  
Citroën 96 062 288  
Peugeot 5970 49

Citroën, Peugeot

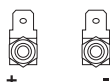
**ZS 220**  
0 040 100 220Ø 40 mm  
↓ 115 mmBosch 0 222 003 001,  
0 222 003 003,  
0 222 003 042**12 Volt, max. 20 kV**  
silber<sup>136</sup>ohne Befestigungsschelle<sup>180</sup>für 1-, 2-Zylinder-Motoren<sup>125</sup>, **ZS 232**  
0 040 100 232

Peugeot 5970 48

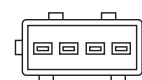

Peugeot

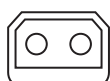
**ZS 224**  
0 040 100 224BMW 12 13 1 341 978,  
12 13 2 306 330  
Bosch 0 221 500 001,  
0 221 500 459BMW 2 Zylinder<sup>130</sup> **ZE 116** - 0 300 811 653**ZS 234** ersetzt<sup>263</sup> ZS 233 -  
0 040 100 234 0 040 100 233Bosch 0 221 503 407  
Alfa Romeo 605 581 52,  
608 096 06,  
7 648 797  
Ferrari 134386  
Fiat/Lancia 605 581 52,  
608 096 06,  
7 648 797  
Rover ERR6045Alfa Romeo, Citroën, Ferrari, Fiat,  
Lancia, Land Rover2 x Zndspulen ZS 234 erforderlich  
für 8 Zylinder-Motoren und Alfa Romeo  
Twin Spark (4 Zylinder)<sup>122</sup>



**ZS 237**  
0 040 100 237

Ford 100 8886, 100 8887, 101 8139, 101 8140, 96FB-12257-AB

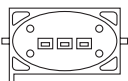

Ford

**ZS 242**  
0 040 100 242

Renault 7700100589



Renault Clio II, Kangoo, Megane (ZS 242 + ZS 243)

**ZS 242** Zylinder<sup>130</sup> 1 + 4  
Steckergehäuse schwarz<sup>120</sup>

**ZS 238**  
0 040 100 238

Ford 618 1956, 650 3278, 650 3277, 650 3377, 88SF-12029-AA

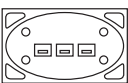

Ford

**ZS 243**  
0 040 100 243

Renault 7700100643



Renault Clio II, Kangoo, Megane (ZS 242 + ZS 243)

**ZS 243** Zylinder<sup>130</sup> 3 + 2  
Steckergehäuse weiss<sup>121</sup>

**ZS 239**  
0 040 100 239

Ford 686 0288, 928F-12029-CA

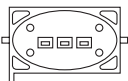

Ford, Mazda

**ZS 244**  
0 040 100 244

Fiat/Lancia 7582152, 7663177, 7698431, 7746152, 7746154

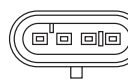

Fiat, Lancia

**ZS 241**  
0 040 100 241

Citroën/Peugeot 5970 56, 5970 A2

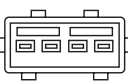

Citroën, Peugeot

**ZS 245**  
0 040 100 245

Renault 7701041607



Renault Megane (ZS 245 + ZS 246)

**ZS 245** Zylinder<sup>130</sup> 1 + 4  
Steckergehäuse schwarz<sup>120</sup>



**ZS 246**  
0 040 100 246

Renault 7701041608

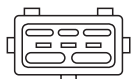

Renault Megane (ZS 245 + ZS 246)

**ZS 246** Zylinder<sup>130</sup> 3 + 2Steckergehäuse weiss<sup>121</sup>**ZS 250**  
0 040 100 250

Renault 7700749450

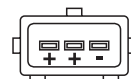

Mazda, Renault

**ZS 247**  
0 040 100 247Citroën 96010513, 97530780  
Peugeot 5970 43

Citroën, Peugeot

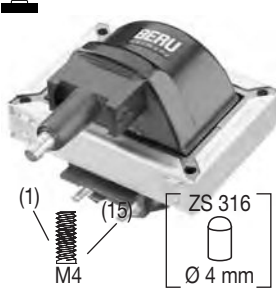
**ZS 251**  
0 040 100 251Bosch F 000 ZSO 115  
Renault 7701031135  
Volvo 3287677-3

Renault, Volvo

**ZS 248**  
0 040 100 248Fiat/Lancia 7553120, 7646974,  
7746153

Fiat, Lancia

**ZS 252**  
0 040 100 252Opel 1208002, 1208004,  
1208036, 1208048  
GM 90449740, 90510387

Opel

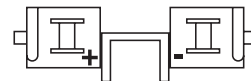
**ZS 249**  
0 040 100 249Citroën 96035284  
Peugeot 5970 45

Citroën, Peugeot

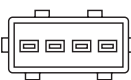
**ZS 253**  
0 040 100 253Opel 1208003, 1208054,  
1208070

Opel





**ZS 254**  
0 040 100 254

Renault 7700863020



Renault, Volvo  
(ZS 254 + ZS 255)

**ZS 254** Zylinder<sup>130</sup> 1 + 4  
Steckergehäuse schwarz<sup>120</sup>

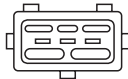

**ZS 258**  
0 040 100 258

Citroën/Peugeot 5970 47



Citroën, Peugeot

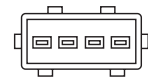

**ZS 255**  
0 040 100 255

Renault 7700863020



Renault, Volvo  
(ZS 254 + ZS 255)

**ZS 255** Zylinder<sup>130</sup> 3 + 2  
Steckergehäuse weiss<sup>121</sup>

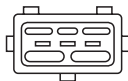

**ZS 259**  
0 040 100 259

Opel 1208307  
GM 19005212



Opel

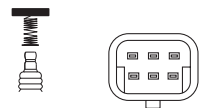

**ZS 256**  
0 040 100 256

Citroën 96 211 048  
Peugeot 5970 51



Citroën, Peugeot

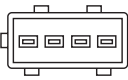

**ZS 261**  
0 040 100 261

Hyundai 27301-32800,  
27301-32810,  
27301-32820  
Mitsubishi MD 104696



Hyundai, Mitsubishi (EU, USA, Korea)

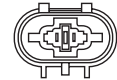

**ZS 257**  
0 040 100 257

Citroën/Peugeot 5970 42



Citroën, Peugeot



**ZS 263**  
0 040 100 263

Hyundai 27301-24510,  
27301-24520  
Mitsubishi MD 114994



Hyundai, Mitsubishi (EU, USA, Korea)





**ZS 264**  
0 040 100 264

Hyundai 27301-22040,  
27301-22050



Hyundai (EU, USA, Korea)

**ZS 274**  
0 040 100 274

Mazda F210 18 100,  
F210 18 100 B,  
F211 18 100 A,  
JF01 18 100 B



Mazda

**ZS 266**  
0 040 100 266

Hyundai 27301-02600



Hyundai, Kia (EU, USA, Korea)

**ZS 275**  
0 040 100 275

Honda 30510PT2006,  
30510P73A01,  
30510P73A02  
Rover GCL 195,  
NEC 100530

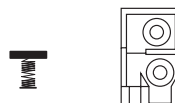

Honda, Rover

**ZS 267**  
0 040 100 267

Hyundai 27301-23003



Hyundai (EU, USA, Korea)

**ZS 276**  
0 040 100 276

Honda 30500PM5A02,  
30500PM5A03  
Rover GCL 161



Honda, Rover

**ZS 269**  
0 040 100 269

Hyundai 27301-37100



Hyundai (EU, USA, Korea)

**ZS 277**  
0 040 100 277

Nissan 224330B00,  
2243355S10,  
2243356E11,  
2243353J20

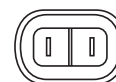

Nissan



**ZS 278**  
0 040 100 278

Honda 30500PR4A02



Honda

**ZS 282**  
0 040 100 282

Mitsubishi MD131711, MD113551

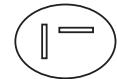

Mitsubishi

**ZS 279**  
0 040 100 279

Ford Mazda  
F1CZ12029A  
B6S71810XA,  
B6S81010XA



Mazda

**ZS 283**  
0 040 100 283

Alfa Romeo 60805420,  
60809492,  
46548037,  
46790073,  
7626232,  
7672018

Alfa Romeo, Fiat, Lancia  
2 x **ZS 283**

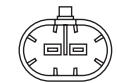

**ZS 280**  
0 040 100 280

Audi/VW Bosch  
330 905 115 A  
0 221 502 007

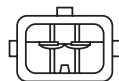

Audi 1984

**ZS 284**  
0 040 100 284

Ducati 28540031 A

Ducati 748/R, 750SS/SSI, 851, 888,  
900SS/SSIE, 907, 996/SPS, 998, ST 2/4

2 x **ZS 284**

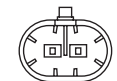

**ZS 281**  
0 040 100 281

Ford  
650 3279,  
650 3280,  
686 0288,  
686 0289,  
88SF12029A1A,  
88SF12029A2A,  
F5RZ12029C

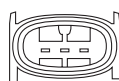

Ford

**ZS 296**  
0 040 100 296

Bosch 0 221 501 003,  
0 221 502 429  
Mercedes Benz A 000 158 61 03

Transistor-Zündanlage<sup>14</sup>

Mercedes Benz (Typ 124/126/140/201/...)

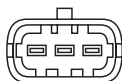
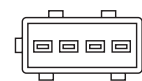
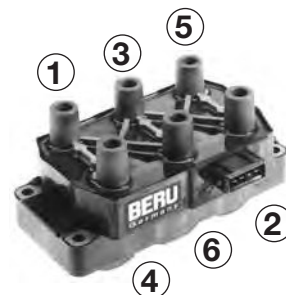

**ZS 297**  
0 040 100 297Bosch 0 221 503 035  
Mercedes Benz A 000 158 78 03Mercedes Benz (Typ 202/203/208/209/  
210/211/220/...)**ZS 301**  
0 040 100 301Bosch 0 221 503 002  
GM/Opel 1208068, 90358386,  
90444148, 90444184  
Saab 4770046

Opel, Saab, Vauxhall

**ZS 298**  
0 040 100 298Bosch 0 221 501 374,  
0 221 502 433  
Mercedes Benz A 000 158 64 03Transistor-Zündanlage<sup>14</sup>  
Mercedes Benz (Typ 124/126/140/...)**ZS 302**  
0 040 100 302Bosch 0 221 504 004  
BMW 12131703227,  
12131703228,  
12131703825,  
12131748018

BMW (E 31/36/39/46, X5, Z3, Z8)

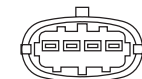
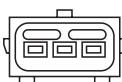
**ZS 299**  
0 040 100 299Bosch 0 221 502 435  
Mercedes Benz A 000 158 65 03Transistor-Zündanlage<sup>14</sup>  
Mercedes Benz (Typ 124/140/...)**ZS 304**  
0 040 100 304Bosch 0 221 503 022  
MCC Smart C 000 3100 V003,  
C 000 3100 V004,  
C 000 3100 V005MCC Smart  
3 x ZS 304 **ZS 300**  
0 040 100 300Bosch 0 221 503 001  
GM/Opel 90443900,  
90449572,  
1208065

Opel, Vauxhall

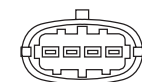
**ZS 306**  
0 040 100 306Bosch 0 221 503 017  
GM/Opel 1208075, 90541062,  
90563160

Opel, Vauxhall (Omega B)



**ZS 307**  
0 040 100 307

Bosch 0 221 503 005,  
0 221 503 489  
BMW 12131247281



BMW (E 34/36/46)

**ZS 311**  
0 040 100 311

Bosch 0 221 504 014  
Fiat/Lancia 46467542

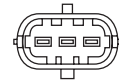

Fiat, Lancia (20V)

**ZS 308**  
0 040 100 308

Bosch 0 221 505 423  
Ford 6485688,  
91XF12029AA,  
91XF12029BA

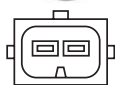

Ford  
2 x **ZS 308**

**ZS 313**  
0 040 103 007

Bosch 0 221 505 437  
Mercedes Benz A 000 150 04 80,  
A 000 158 68 03



Ø 3 mm



Mercedes Benz (Typ 124/202)  
 **VS 106** - 0 300 404 107

**ZS 309**  
0 040 100 309

Bosch 1 227 030 062  
Alfa Romeo 46469863

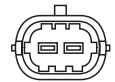

Alfa Romeo 145/146/166  
 **ZLE 288** - 0 300 122 122 (2 kΩ)  
4 x **ZS 309**

**ZS 314**  
0 040 100 314

Bosch 9 220 081 504,  
F 000 ZS 0105  
VW 377 905 105 D

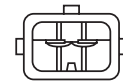

Mazda (Südafrika), VW (Mittelamerika/  
Südamerika/Brasilien/Südafrika)

**ZS 310**  
0 040 100 310

Bosch 0 221 504 005,  
0 221 504 006  
Fiat/Lancia 46403328

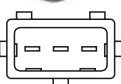

Fiat, Lancia (20V)

**ZS 315**  
0 040 100 315

Renault 7700107269

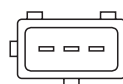

Renault  
2 x **ZS 315**



**ZS 316**  
0 040 100 316

Renault  
(Siemens/  
Magneti Marelli)

7701031135

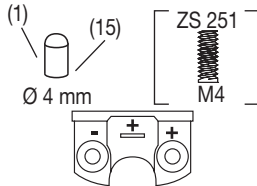

Renault, Volvo

**ZS 320**  
0 040 100 320

Fiat 46777286, 55180004

Fiat Doblo, Stilo (1.6)

182 B6.000



**ZS 317**  
0 040 100 317

Renault 7700854306,  
7700872265

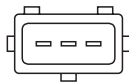

Renault  
Typ A/K  
Steckergehäuse schwarz<sup>120</sup>

**ZS 321**  
0 040 100 321

Bosch Fiat 0 221 504 460,  
46777287, 46776830

Fiat Stilo 16V (2.4)

192 A2.000



**ZS 318**  
0 040 100 318

Renault 7700854307,  
7700872692

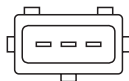

Renault  
Typ B/K  
Steckergehäuse grau<sup>118</sup>

**ZS 322**  
0 040 100 322

Fiat 46777288

Fiat Stilo 16V (1.2, 1.6)

188 A5.000



**ZS 319**  
0 040 100 319

Renault 7700858320,  
7700872693

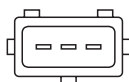

Renault  
Typ C/K  
Steckergehäuse braun<sup>119</sup>

**ZS 323**  
0 040 100 323

Citroën Peugeot 9611412080,  
5970.50

Citroën, Peugeot ('92 )





**ZS 324**  
0 040 100 324

BMW  
12 13 1 712 223,  
1 712 223,  
12 13 7 551 260,  
7 551 260,  
12 13 1 712 219,  
1 712 219,  
12 13 0 390 064,  
0 390 064,  
12 13 0 148 594,  
0 148 594



BMW

**ZS 337**  
0 040 100 337

Bosch 0 221 504 017  
Nissan 22448 1F700



Nissan Micra

**ZS 325**  
0 040 100 325

Renault 8200702693



Renault  
ZEF 1604 - 0 300 891 604

**ZS 338**  
0 040 100 338

Bosch 0 221 503 472  
GM/Opel 1208020, 24420584,  
93177212

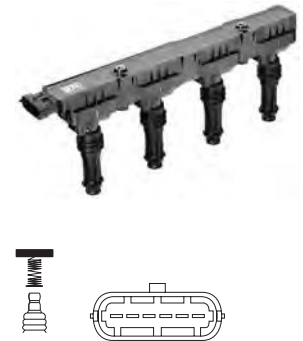

Opel, Vauxhall

**ZS 326**  
0 040 100 326

Nissan 22433-F4302



Isuzu, Opel, Vauxhall

**ZS 339**  
0 040 100 339

Bosch 0 221 501 007,  
0 221 502 431  
MB 000 158 62 03,  
A 000 158 62 03



**12 Volt**  
Zündspule für Transistor-Zündanlage<sup>55</sup>  
Mercedes Benz

**ZS 327**  
0 040 100 327

Seat SE 028915.000B



Seat  
2 x **ZS 327**

**ZS 340** ersetzt<sup>263</sup> ZS 295  
0 040 100 340

Bosch 0 221 503 012,  
0 221 506 444  
MB A 000 150 02 80,  
A 000 158 70 03



Daewoo, Mercedes Benz, Puch,  
Ssangyong  
**ZLE 234** - 0 300 122 111 (2 kΩ)  
**VS 107** - 0 300 404 108



**ZS 341**  
0 040 100 341

Citroën 5970.60  
96074054  
Fiat 9607405480

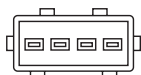

Citroën, Fiat, Lancia

**ZS 345**  
0 040 100 345

Renault 82 00 141 149

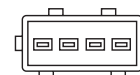

Renault

**ZS 342**  
0 040 100 342

Opel 1208008  
GM 90536194, 09119567,  
9119567



Opel, Saab

**ZS 346**  
0 040 100 346

Citroën 0000597055, 96213181  
Peugeot 5970.55

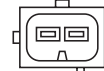

Citroën, Peugeot

**ZS 343**  
0 040 100 343

Citroën 0000597057  
Peugeot 5970.57

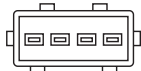

Citroën, Peugeot

**ZS 347**  
0 040 100 347

Citroën 0000597077  
Fiat 0009633001580  
Peugeot 5970.77  
Renault 9633001580



Citroën, Fiat, Lancia, Peugeot, Renault

**ZS 344**  
0 040 100 344

GM 90 458 250  
Opel 12 08 071

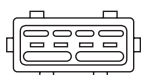

Opel, Vauxhall

**ZS 348**  
0 040 100 348

Citroën 0000597075  
Peugeot 5970.75, 5970.98



Citroën, Peugeot



**ZS 349**  
0 040 100 349

Citroën 0000597073, 96292106  
Peugeot 5970.73

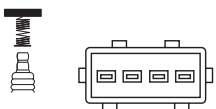

Citroën, Peugeot

**ZS 353**  
0 040 100 353

Citroën 0000597092  
Peugeot 5970.92

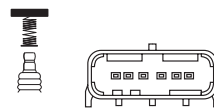

Peugeot

**ZS 350** ersetzt<sup>263</sup> ZSE 035 – 0 040 102 035  
0 040 100 350

Ford 1317972,  
988F12029AD,  
1S7G12029AC,  
95WF12029BA,  
YM2F12029AD  
Mazda 1E041810X,  
1E0518100B



Ford

**ZS 354**  
0 040 100 354

Renault 77 00 274 008



Dacia, Nissan, Renault

**ZS 351**  
0 040 100 351

Citroën 0000597084  
Peugeot 5970.84

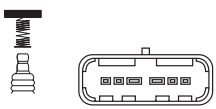

Citroën, Peugeot

**ZS 355**  
0 040 100 355

GM 10467067, 10468391,  
10472401  
Opel 1208006, 1208061



3 x **ZS 355** Isuzu, Opel, Vauxhall

**ZS 352**  
0 040 100 352

Citroën 0000597087  
Peugeot 5970.87

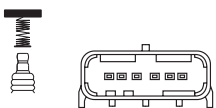

Citroën, Peugeot

**ZS 356**  
0 040 100 356

GM 94 404545, 94 853 695  
Isuzu 8-94404-545-0  
Toyota 90919-02164

Klemme: +/-

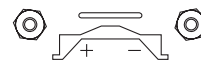

Toyota



**ZS 357**  
0 040 100 357

Bosch 0 221 502 460  
Porsche 99360207101



Porsche

**ZS 361**  
0 040 100 361

Bosch 1 227 030 071  
Alfa Romeo 46755605  
Fiat 71713719

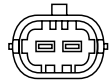

4 x ZS 361   
Alfa Romeo

**ZLE 276** - 0 300 122 122 (2 kΩ)

**ZS 358**  
0 040 100 358

Bosch 0 221 503 014  
Opel 1208306, 90543059,  
90532618

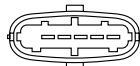

Opel, Vauxhall

**ZS 365**  
0 040 100 365

Ford 1319788,  
1S7G-12029-AC,  
1119835,  
1S7G-12029-AB

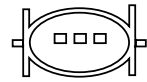

Ford

**ZS 359**  
0 040 100 359

Bosch 0 221 503 471  
Opel 1208028, 24420622,  
93180806

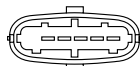

Opel, Vauxhall

**ZS 366**  
0 040 100 366

Ford F6DU12A366AB,  
F6DU12A366AC



Ford

**ZS 360**  
0 040 100 360

Bosch 0 221 506 453  
Ford 7390767,  
V93HF12029AA

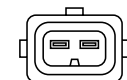

Ford

**ZS 367**  
0 040 100 367

Ford 2W4E-12A366-AC,  
2W4E-12A366-AD,  
2W4Z-12029-A,  
5008049  
Jaguar C2S42751  
XR842741



Ford, Jaguar



**ZS 368**  
0 040 100 368

Ford 2W4E-12A366-BB,  
2W4E-12A366-BC,  
2W4E-12A366-BD,  
2W4E-12A366-BE,  
2W4Z-12029-B,  
2W4Z-12029-BC,  
2W4Z-12029-BD,  
4424413,  
4586554,  
4667153,  
5008050  
Jaguar XR827823



Ford, Jaguar

**ZS 372**  
0 040 100 372

Ford 4751265, 5008190,  
5F2E12029AA,  
5F2E12029AB

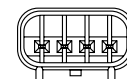

Ford

**ZS 369**  
0 040 100 369

Ford 4L7E-12A366-AA  
4L7E-12A366-AB  
4L7Z-12029-AB



Ford

**ZS 375**  
0 040 104 100

Renault 8200360911



inkl. ZEF 1604 - 0 300 891 604

Renault

ZEF 1604 - 0 300 891 604

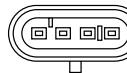

**ZS 370**  
0 040 100 370

Ford F57U12029AA  
F57U12029AB

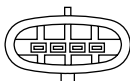

Ford

**ZS 376**  
0 040 100 376

Nissan 22433-53F00,  
22433-55Y00, -65Y10,  
22448-1C701,  
22448-37J10,  
22448-37J11,  
22448-37J20



Nissan

**ZS 371**  
0 040 100 371

Ford 5008196, 6489415,  
6630365, 6958305,  
919F12029AA,  
E9SF12029AA,  
E9SZ12029A,  
F1SU12029AA,  
F5SU12029AA,  
F5SU12029AB

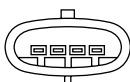

Ford

**ZS 377**  
0 040 104 006

Benelli O. J. 0500 033 012 000,  
R 0500 033 012 000

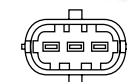

3 x ZS 377/

Benelli TnT 899, TnT 899S, Trek 899

**ZS 378**

0 040 104 002

MV Agusta 8000A6700

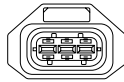

4 x ZS 378

MV Agusta

**ZS 382**

0 040 100 382

BMW 12 13 7510 738

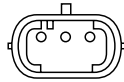

Mini (R50, R52, R53)

**ZS 379**0 040 100 379 ersetzt<sup>263</sup> ZSE 027 - 0 040 102 027Chrysler 04557468, 04609080,  
04671025  
Mitsubishi M04557468mit Endstufe<sup>106</sup>Chrysler, Dodge, Eagle, Mitsubishi,  
Plymouth (USA)**ZS 383**

0 040 100 383

BMW 8520173, 7715857,  
7698929Zylinder links 1 x **ZS 383** + 1 x ZS 385  
Zylinder rechts 1 x ZS 384 + 1 x ZS 385 (2 Zylinder<sup>130</sup>) BMW HP2 Megamoto,  
-Sport / R1200 GS, -GS adv., -RT, -S**ZS 380**0 040 100 380 ersetzt<sup>263</sup> ZSE 028 - 0 040 102 028Chrysler 05269670, 56032521  
Mitsubishi M05269670mit Endstufe<sup>106</sup>

Chrysler, Dodge, Jeep (USA)

**ZS 384**

0 040 100 384

BMW 8520174, 7715856,  
7696510, 7692262,  
7676572Zylinder links 1 x ZS 383 + 1 x ZS 385  
Zylinder rechts 1 x **ZS 384** + 1 x ZS 385 (2 Zylinder<sup>130</sup>) BMW HP2 Megamoto,  
-Sport / R1200 GS, -GS adv., -RT, -S**ZS 381**

0 040 100 381

Peugeot 5970.A9, 5970.74

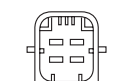

Citroën, Peugeot

**ZS 385**

0 040 100 385

BMW 8520154, 7715853,  
7680644, 7671896Zylinder links 1 x ZS 383 + 1 x **ZS 385**  
Zylinder rechts 1 x ZS 384 + 1 x **ZS 385** (2 Zylinder<sup>130</sup>) BMW HP2 Megamoto,  
-Sport / R1200 GS, -GS adv., -RT, -S



**ZS 386**  
0 040 100 386

BMW 4645117, 7670815,  
7709080, 7715846



1 x ZS 386 /

(2 Zylinder<sup>130</sup>) BMW F 650 GS,  
F 800 GS, -R, -S, -ST

(2 Zylinder<sup>130</sup>) BMW K 1200 GT, -R,  
-Rsport, -S / K 1300 GT, -R, -S, -T

**ZS 392**  
0 040 100 392

Chrysler 05269670AB



**ZS 387**  
0 040 100 387

Ford 1350562, 1459278,  
1727629, 1754514,  
4M5G-12029-ZA,  
4M5G-12029-ZB,  
CM5G12029FA,  
CM5G12029FB

Volvo 30731416,  
30731419

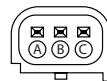

Ford

**ZS 393**  
0 040 100 393

Chrysler 4762312



Chrysler

**ZS 388**  
0 040 100 388

Aston Martin 4G43-12A366-BA,  
8G43-12A366-AA,  
6G33-12A366-CA

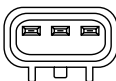

Aston Martin

**ZS 394**  
0 040 100 394

Chrysler 4797293

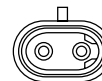

Chrysler

**ZS 389**  
0 040 100 389

Aston Martin 9G33-12A366-AA



Aston Martin

**ZS 395**  
0 040 100 395

Fispa 85.30347  
Lada 21110370501000,  
21113705010  
Mitsubishi 9311600



**ZS 396**  
0 040 100 396

Chrysler 56028172AB



Chrysler

**ZS 405**  
0 040 100 405

Chrysler 4443971

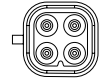

Chrysler

**ZS 398**  
0 040 100 398

Chrysler 53006566

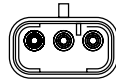

Chrysler

**ZS 406**  
0 040 100 406

Chrysler V 7203971AA

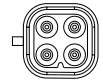

Chrysler

**ZS 400**  
0 040 100 400

Bosch 0 221 122 001

Ø 55 mm  
↑ 150 mm

**12 Volt, max. 35 kV**  
ohne Startspannungsanhebung<sup>127</sup>  
Zündspule für Transistorzündung, blau<sup>137</sup>  
Transistor-Zündanlage<sup>14</sup>  
Nach DIN 72531, mit internationaler  
Befestigungsschelle<sup>162</sup>

BMW, Porsche, Peugeot, Renault,  
Mercedes-Benz, Maserati, Volvo**ZS 407**  
0 040 100 407

Chrysler 53006565



Chrysler

**ZS 404**  
0 040 100 404

Chrysler 5252673



Chrysler

**ZS 408**  
0 040 100 408Ford 1224925, 1314271,  
1322402, 1578771,  
4M5E12A366AA,  
4M5G12A366BA,  
4M5G12A366BB,  
4M5G-12A366-BC,  
4M5G12A366-BD,  
4M5U-12A366-BC,  
5047437,  
AM5E12A366AA,  
AM5E12A366AB

Ford



**ZS 409**  
0 040 100 409

Ford 3W7E-12A366-AA



Ford



**ZS 418**  
0 040 100 418

Honda 30510-PV1-A01



Honda



**ZS 410**  
0 040 100 410

Ford 9L8E12A366AA



Ford



**ZS 419**  
0 040 100 419

Honda 30520-PT-3-A02



Honda



**ZS 416**  
0 040 100 416

General Motors GM 25518356



GM



**ZS 421**  
0 040 100 421

Saturn 21020180



Saturn



**ZS 417**  
0 040 100 417

Honda 30520-PH6-900,  
30520-PH6-902



Honda



**ZS 422**  
0 040 100 422

Ford 1111213, 1319929,  
1517813, 1619343,  
988F12029BA,  
YM2F12024AB,  
YM2F12024AC,  
YM2F12029AB



Ford



**ZS 426**  
0 040 100 426

Aston Martin 4G4E-12A366-AA



Aston Martin

**ZS 430**  
0 040 100 430

Toyota 90919-02215

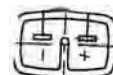
**ZS 427**  
0 040 100 427

Opel 10 458 316, 12 080 21

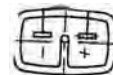

Fiat, Opel, Vauxhall

**ZS 431**  
0 040 100 431Chrysler K 04609095 AD,  
K 04609095 AE,  
K 04609095 AF,  
K 04609095 AG,  
K 04609095 AH,  
K 04609095 AI

Anschlußtechnik SAE

**ZS 428**  
0 040 100 428Alfa Romeo 60562701  
Fiat 60810690**ZS 432**  
0 040 100 432Chrysler 00K 04609088 AG,  
04609088 AB,  
04609088 AC,  
04609088 AD,  
04609088 AE,  
04609088 AF,  
K 04609088 AF,  
K 04609088 AH

Anschlußtechnik SAE

**ZS 429**  
0 040 100 429

Volvo 1275602

**ZS 433**  
0 040 100 433Hyundai OK 247-18100  
Kia OK 247-18100,  
OK 247-18100 A  
Mazda K 247-18100



**ZS 434**  
0 040 100 434

Hyundai OK 013-18-100  
Kia OK 013-18-100  
Mazda K 013-18-100

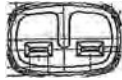

**ZS 438**  
0 040 100 438

Proton A2C53283940



**ZS 435**  
0 040 100 435

Rover NEC101010L



**ZS 439**  
0 040 100 439

Ducati 38040221 B

Herstellereinschränkung  
Motorradsymbol: Ducati  
Herstellereinschränkung Panigale 1199



**ZS 436**  
0 040 100 436

Hyundai OK 2A 318 100A  
Kia OK 2A3-18100 A  
Mazda K 2A 318 100A



**ZS 440**  
0 040 100 440

Fispa 85.30396

Anschlußausführung Sägezahn  
Herstellereinschränkung  
Motorradsymbol: Piaggio  
Herstellereinschränkung MP 3



**ZS 437**  
0 040 100 437

Rover NEC101000L



**ZS 441**  
0 040 104 009

Ducati 38010144 B

Herstellereinschränkung  
Motorradsymbol: Ducati  
Herstellereinschränkung 696



**ZS 443**  
0 040 104 010

KTM 611 39 006 000

Anschlußtechnik SAE  
Herstellereinschränkung  
Motorradsymbol: KTM  
Herstellereinschränkung Super Duke  
R 990 Herstellereinschränkung 97 KW  
/ 131 PS Herstellereinschränkung Bj.  
2008-2010**ZS 451**  
0 040 100 451Opel 12 08 007, 90 492 255,  
90 511 450

Anschlußausführung Sägezahn

**ZS 444**  
0 040 104 011

Ducati 38040161 A

Herstellereinschränkung  
Motorradsymbol: DUCATI  
Herstellereinschränkung Desmosedici  
16 RR Herstellereinschränkung 147  
KW / 200 PS Herstellereinschränkung  
Bj. 2008**ZS 501** ersetzt<sup>263</sup> ZS 509  
0 040 100 501Land Rover NEC 000120 L,  
NEC 100730 LSteckerfarbe: schwarz<sup>120</sup>  
Land Rover**ZS 449**  
0 040 100 449Toyota 90080-19017,  
90080-1901700**ZS 502**  
0 040 100 502Rover NEC 000130,  
NEC 100870Steckerfarbe: rot<sup>117</sup>  
Lotus, MG, Rover**ZS 450**  
0 040 100 450

Opel 12 08 076, 90 506 102



Anschlußausführung Sägezahn

**ZS 507**  
0 040 100 507

Ducati 38010151 A

Ducati Multistrada 620  
Ducati Monster S2R 800  
Ducati Monster 6952 x **ZS 507**



**ZS 508**  
0 040 100 508

Buick 96 415 010  
Chevrolet 96 415 010



**ZS 516**  
0 040 100 516

Saipa 5WY2837A



Zündspule Anschlußausführung DIN  
Steckergehäuse schwarz<sup>120</sup>  
zum Zyl. 1 + 4  
Steckergehäuse grau<sup>118</sup>  
zum Zyl. 2 + 3

**ZS 511**  
0 040 100 511

Kia KK137-18-10XB,  
KK137-18-10XC



Hyundai, Mitsubishi, Nissan, Kia

**ZS 518**  
0 040 100 518

Chery S11-3705100



Zündspule Anschlußausführung DIN

**ZS 513**  
0 040 100 513

Saipa 5WY2809, 5WY2809 A



Zündspule Anschlußausführung DIN  
Steckergehäuse schwarz<sup>120</sup>  
zum Zyl. 1 + 4  
Steckergehäuse grau<sup>118</sup>  
zum Zyl. 2 + 3

**ZS 519**  
0 040 100 519

Daelim 30510-BA1-R300



Zündspule Anschlußausführung  
DIN Herstellereinschränkung  
Motorradsymbol: DAELIM  
Herstellereinschränkung Motorbike VL  
125

**ZS 515**  
0 040 100 515

IKCO 5WY2829A



Steckergehäuse grau<sup>118</sup>  
zum Zyl. 1 + 4  
Steckergehäuse schwarz<sup>120</sup>  
zum Zyl. 2 + 3

**ZS 520**  
0 040 100 520

Daelim 30510-SA7-RZ00



Zündspule Anschlußausführung  
DIN Herstellereinschränkung  
Motorradsymbol: DAELIM  
Herstellereinschränkung Otello 125,  
SL125U Herstellereinschränkung  
Scooter

**ZS 521**  
0 040 100 521

Hyundai 27301-33510,  
27301-33520  
Kia 27301-33510,  
27301-33520  
Mitsubishi 27301-33510



Zündspule Anschlußausführung DIN

**ZS 526**  
0 040 100 526

Hyundai 27301-32840,  
27301-32850

**ZS 522**  
0 040 100 522

Hyundai 27301-37105



Zündspule Anschlußausführung DIN

**ZS 532**  
0 040 100 532

Honda 30500-POA-A01,  
30500-PCA-003,  
30500-PDA-E01

**ZS 523**  
0 040 100 523

Daelim 30510-BA4-R300



Herstellereinschränkung  
Motorradsymbol: DAELIM  
Herstellereinschränkung Daelim VJ 125

**ZS 535**  
0 040 100 535

UAZ (Russia) 3163-00-3705013



Anschlußtechnik Kontaktfeder

**ZS 524**  
0 040 100 524

Daelim 30510-SA4-R300



Herstellereinschränkung  
Motorradsymbol: DAELIM  
Herstellereinschränkung Daelim SQ 125

**ZS 536**  
0 040 100 536

Hyundai 27301-03000,  
27301-03010,  
27301-03030



Zündspule Anschlußausführung DIN



**ZS 537**  
0 040 100 537

Ssangyong A 172 158 00 03,  
A 172 158 01 03



**ZSE 004**  
0 040 402 004

VW 021 905 106  
Ford 95 VW 12029 AA,  
1008464  
Mercedes-Benz A 003 158 5001



Ford, Mercedes-Benz, Seat, Volkswagen  
(6-Zylinder<sup>130</sup>)  
mit Endstufe<sup>123</sup>



**ZSE 001**  
0 040 402 001

Bosch 0 221 601 003  
Audi/VW 867 905 104,  
867 905 104 A,  
867 905 352  
Seat 6 NO 905 104  
Skoda 004 050 016



Audi, Seat, Volkswagen

**ZM 013**  
mit Endstufe<sup>123</sup>

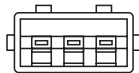

**ZSE 006**  
0 040 402 006

Audi/VW 8D0 905 105



Audi, Volkswagen

**ZM 030**  
mit Endstufe<sup>123</sup>

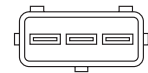

**ZSE 002**  
0 040 402 002

Bosch 0 221 601 001,  
0 221 601 002  
Seat 867 905 105 A  
VW 701 905 104,  
701 905 104 A,  
867 905 105 A



Audi, Seat, Volkswagen

mit Endstufe<sup>123</sup>

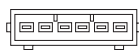

**ZSE 007**  
0 040 402 007

Audi 078 905 101 A



Audi

Kabellänge [mm] 75/85

mit Endstufe<sup>123</sup>



**ZSE 003**  
0 040 402 003

Audi/VW 032 905 106,  
032 905 106 B



Audi, Volkswagen

mit Endstufe<sup>123</sup>

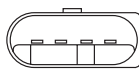

**ZSE 008**  
0 040 402 008

Audi 078 905 101 C



Audi

Kabellänge [mm] 75/145

mit Endstufe<sup>123</sup>





**ZSE 009**  
0 040 402 009

Audi/VW  
06B 905 115,  
06B 905 115 B,  
06B 905 115 E

Audi A3, 6, 8, TT, Seat,  
Volkswagen Beetle

mit Endstufe<sup>123</sup>



**ZSE 013**  
0 040 102 013

VW  
021 905 106 B,  
021 905 106 C

Volkswagen (6-Zylinder<sup>130</sup>)  
mit Endstufe<sup>123</sup>



**ZSE 010**  
0 040 402 010

Mitsubishi  
HQ 808700

Hyundai, Kia, Mitsubishi (EU, USA, Korea)  
mit Endstufe<sup>123</sup>



**ZSE 019**  
0 040 102 019

Bosch  
0 221 604 001,  
0 221 604 008  
Volvo  
9125601, 30713416

Volvo (70/80/90)  
mit Endstufe<sup>123</sup>



**ZSE 011**  
0 040 402 011

Hyundai  
27301-02502

Hyundai, Kia, Mitsubishi (EU, USA, Korea)  
mit Endstufe<sup>123</sup>



**ZSE 021**  
0 040 102 021

Nissan  
22448-4M500

Nissan



**ZSE 012**  
0 040 102 012

Porsche  
948 602 104.00,  
948 602 104.01,  
948 602 104.03,  
948 602 104.06,  
948 602 104.07,  
948 602 104.08,  
948 602 104.09

Porsche

GS 28 - 0 010 020 028  
mit Endstufe<sup>123</sup>



**ZSE 026**  
0 040 102 026

Opel  
10 45 7075, 11 03 872,  
11 03 905, 12 08 063

Zündspule Endstufe<sup>123</sup>  
Anschlußausführung Sägezahn





**ZSE 029**  
0 040 102 029

VW 06A 905 097,  
06A 905 104

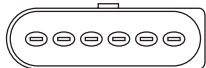

Volkswagen (EU, USA)  
mit Endstufe<sup>123</sup>

**ZSE 033**  
0 040 102 033

VW 07K 905 715/-A/-B/-C/  
-D/-E/-F  
06F 905 115/-A/-B/-C/  
-D/-F



Audi, Volkswagen  
BERU ZSA 044/0 890 300 044  
mit Endstufe<sup>123</sup>

**ZSE 030**  
0 040 102 030

VW 036 905 100 A/-B/-C/-D  
036 905 715/-A/-C/-E, F



Audi, Volkswagen  
BERU ZSA 042/0 890 300 042  
mit Endstufe<sup>123</sup>

**ZSE 037**  
0 040 102 037

Bosch 0 221 601 012  
Renault 7401275174  
Volvo 1275174

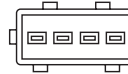

Renault, Volvo  
BERU ZM 036  
mit Endstufe<sup>123</sup>

**ZSE 031**  
0 040 102 031

VW 07C 905 715,  
07C 905 715 A,  
07C 905 115 J

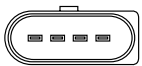

Volkswagen  
BERU ZSA 042/0 890 300 042  
mit Endstufe<sup>123</sup>

**ZSE 039**  
0 040 102 039

Audi/VW 047 905 104

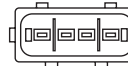

Seat, Skoda, Volkswagen

**ZSE 032**  
0 040 102 032

VW 06E 905 115/-A/-B/-C/  
-D/-E  
06D 905 115/-A/-C/-D/  
-F/-G/-J/-K

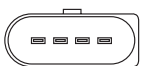

Audi  
BERU ZSA 044/0 890 300 044  
mit Endstufe<sup>123</sup>  
Zündspulenkopf<sup>64</sup> rot<sup>117</sup>

**ZSE 040**  
0 040 102 040

Audi/VW 047 905 104 A/-B



Skoda



**ZSE 041**  
0 040 102 041

VW 022 905 100 B/-E/-H/-L/  
-P/-S/-T,  
022 905 715/-A



mit Endstufe<sup>123</sup>

Audi, Skoda, Volkswagen (FSI )

**ZSE 045**  
0 040 102 045

Citroën 0000597080  
Peugeot 5970.80



Citroën, Peugeot

**ZSE 042** ersetzt<sup>263</sup> ZSE 053  
0 040 102 042

Porsche 948 602 104 02, 04,  
06, 10  
948 602 104 41



Porsche

 Porsche GS 28 0 010 020 028

Zündspulenkopf<sup>f64</sup> rot<sup>42</sup>

**ZSE 046**  
0 040 102 046

Citroën 0000597081  
Peugeot 5970.81



Citroën, Peugeot

**ZSE 043** ersetzt<sup>263</sup> ZSE 034 – 0 040 102 034  
0 040 102 043

VW 06A 905 115/-A/-B/-C/-D  
06B 905 115 /-D/-G/-H/  
-J/-L  
06C 905 115 C



Audi, Seat, Skoda, VW

 ZSA 044/0 890 300 044

mit Endstufe<sup>123</sup>

**ZSE 047**  
0 040 102 047

Citroën 0000597078,  
0000597079, 96358649  
Peugeot 5970.78, 5970.79



Citroën, Peugeot

**ZSE 044**  
0 040 102 044

Porsche 955 602 101 05  
VW 022 905 100 B/-E/-H/-L/  
-L/-P/-S/-T,  
022 905 715



Porsche, Volkswagen

 ZSA 043/0 890 300 043

mit Endstufe<sup>123</sup>

**ZSE 048**  
0 040 102 048

Citroën 0000597090,  
9654347080  
Peugeot 5970.90



Citroën, Peugeot



**ZSE 051**  
0 040 102 051

Audi 06C 905 115 A /-B /-D /  
-E /-F,  
06C 905 115 G /-H /-K /  
-L /-M

mit Endstufe<sup>123</sup>  
Zündspulenkopf<sup>f64</sup> rot<sup>42</sup>  
Audi



**ZSE 056**  
0 040 102 056

Nissan 22448ED800,  
22448ED800 EP

mit Endstufe<sup>123</sup>  
Nissan



**ZSE 052**  
0 040 102 052

Porsche 9A1 602 104 00,  
9A1 602 104 01,  
9A1 602 104 02,  
9A1 602 104 03,  
9A1 602 104 04

mit Endstufe<sup>123</sup>  
Zündspulenkopf<sup>f64</sup> grau<sup>118</sup>  
Porsche



**ZSE 059**  
0 040 102 059

VW 03D 905 115 A /-B /-C /  
-D /-E /-F,  
03D 905 715 A

mit Endstufe<sup>123</sup>  
Seat, Skoda, VW



**ZSE 054**  
0 040 102 054

Porsche 980 602 904 00

mit Endstufe<sup>123</sup>  
Porsche Carrera GT



**ZSE 061**  
0 040 102 061

Audi 077 905 115 B /-C /  
-E /-F,  
077 905 115 H /-K /-P /  
-Q /-T

mit Endstufe<sup>123</sup>  
Zündspulenkopf<sup>f64</sup> rot<sup>42</sup>  
Audi



**ZSE 055**  
0 040 102 055

Ford 1371601, 6M5G12029AA  
Volvo 30713417, 8677837

mit Endstufe<sup>123</sup>  
Steckergehäuse grau<sup>118</sup>  
Ford, Volvo



**ZSE 062**  
0 040 102 062

Audi 077 905 115 AA /-G /  
-J /-M /-R /-S

mit Endstufe<sup>123</sup>  
Audi, Volkswagen





**ZSE 063**  
0 040 102 063

VW 022 905 100 A/-D/-G /  
-K/-N, 022 905 715 C

mit Endstufe<sup>123</sup>  
Audi, Ford, Volkswagen



**ZSE 068**  
0 040 102 068

AUDI, SKODA, VW 06J 905 110 B,  
06J 905 110 C,  
06J 905 110 D,  
06J 905 110 E

Endstufe<sup>123</sup>



**ZSE 065**  
0 040 102 065

VW 066 905 100 /-B/-C/  
-D/-G

mit Endstufe<sup>123</sup>  
Volkswagen



**ZSE 069**  
0 040 102 069

Suzuki 33400-62J00,  
33400-62J00-000,  
33400-83E00,  
33400-83E00-000,  
33400-83E10,  
33400-83E10-000

Endstufe<sup>123</sup>



**ZSE 066**  
0 040 102 066

Renault 8200726341,  
8200959964,  
224337085R

mit Endstufe<sup>123</sup>  
Renault H4J700



**ZSE 071**  
0 040 102 071

Nissan 22448-31U05,  
22448-31U06,  
22448-31U15,  
22448-31U16

Anschlußtechnik SAE Endstufe<sup>123</sup>  
Einbauseite Anbau links<sup>280</sup>



**ZSE 067**  
0 040 102 067

VW, SEAT, SKODA 04C 905 110 B,  
04C 905 110 D

Endstufe<sup>123</sup>



**ZSE 072**  
0 040 102 072

Suzuki 33410-77E20,  
33410-77E21,  
33410-77E22

Anschlußtechnik SAE Endstufe<sup>123</sup>





**ZSE 073**  
0 040 102 073

Nissan 22448-31U00,  
22448-31U01

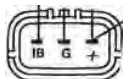

Anschlußtechnik SAE Endstufe<sup>123</sup>  
Einbauseite Anbau rechts<sup>281</sup>

**ZSE 077**  
0 040 102 077

Nissan 22448-2Y006,  
22448-2Y007

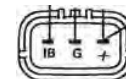

Anschlußtechnik SAE Endstufe<sup>123</sup>

**ZSE 074**  
0 040 102 074

Nissan 22448-3H000

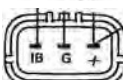

Anschlußtechnik SAE Endstufe<sup>123</sup>

**ZSE 078**  
0 040 102 078

Nissan 22448-2Y000

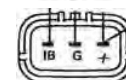

Anschlußtechnik SAE Endstufe<sup>123</sup>

**ZSE 075**  
0 040 102 075

Nissan 22448-2Y001

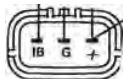

Anschlußtechnik SAE Endstufe<sup>123</sup>

**ZSE 079**  
0 040 102 079

Nissan 22433-8J115,  
22433-8J11C,  
22448-8J11C

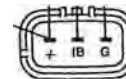

Endstufe<sup>123</sup>

**ZSE 076**  
0 040 102 076

Nissan 22448-4W011

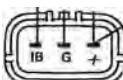

Anschlußtechnik SAE Endstufe<sup>123</sup>

**ZSE 080**  
0 040 102 080

Nissan 22448-8H310,  
22448-8H311,  
22448-8H314,  
22448-8H315



Endstufe<sup>123</sup>

**ZSE 081**  
0 040 102 081

Nissan 22448-6N000,  
22448-6N002  
22448-6N010  
22448-6N012  
22448-6N015

Endstufe<sup>123</sup>**ZSE 086**  
0 040 102 086

Hyundai 27300-39000,  
27300-39050  
Kia 27300-39000,  
27300-39050

Endstufe<sup>123</sup>**ZSE 082**  
0 040 102 082

Nissan 22448-2Y005

Anschlußtechnik SAE Endstufe<sup>123</sup>**ZSE 087**  
0 040 102 087

Hyundai 27300-39700

Endstufe<sup>123</sup>**ZSE 083**  
0 040 102 083

Mazda FP85 18 100 A,  
FP85 18 100 B,  
FP85 18 100 C,  
FPY 118 100

Anschlußtechnik SAE Endstufe<sup>123</sup>**ZSE 088**  
0 040 102 088

Nissan 22448-ED00 0,  
22448-JA00 A,  
22448-JA00 C  
Renault 22448-ED00 0,  
22448-JA00 A,  
22448-JA00 C

Endstufe<sup>123</sup>**ZSE 084**  
0 040 102 084

Mazda BP6D 18 100 A

Anschlußtechnik SAE Endstufe<sup>123</sup>**ZSE 126**  
0 040 102 126

Seat, Skoda, VW 04E 905 110 A  
04E 905 110 B

Endstufe<sup>123</sup>



**ZSE 127**  
0 040 102 127

Ferrari 248406



Zündspule Anschlussausführung  
Sägezahn Endstufe<sup>123</sup>

**ZSE 131**  
0 040 102 131

Dacia 224332428R  
Renault 22 43 32428R



Endstufe<sup>123</sup>

**ZSE 128**  
0 040 102 128

Ferrari 248404



Zündspule Anschlussausführung  
Sägezahn Endstufe<sup>123</sup>

**ZSE 132**  
0 040 102 132

Nissan 22448-AL615,  
22448-AL61C



Endstufe<sup>123</sup>

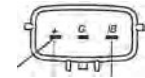

**ZSE 129**  
0 040 102 129

Lamborghini 07M 905 115 E



Zündspule Anschlussausführung  
Sägezahn Endstufe<sup>123</sup>

**ZSE 133**  
0 040 102 133

Isuzu 8-12596-547-0



Endstufe<sup>123</sup>

**ZSE 130**  
0 040 102 130

Aprilia 640905



Endstufe<sup>123</sup> Herstellereinschränkung  
Motorradsymbol: Aprilia  
Herstellereinschränkung Dorsoduro 750  
Herstellereinschränkung Shiver 750

**ZSE 134**  
0 040 102 134

Nissan 22448-7S015



Endstufe<sup>123</sup>



**ZSE 135**

0 040 102 135

Isuzu

8-97315-438-0

Endstufe<sup>123</sup>**ZSE 140**

0 040 102 140

Mercedes

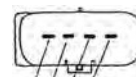
000 150 19 80,  
000 150 27 80,  
272 906 00 60,  
A 000 150 19 80,  
A 000 150 27 80,  
A 272 906 00 60Endstufe<sup>123</sup>**ZSE 136**

0 040 102 136

Suzuki

33410-66D00,  
33410-66D00-000,  
33410-66D01  
33410-66D01-000  
33410-66D10  
33410-66D10-000Zündspule Anschlussausführung  
Sägezahn Endstufe<sup>123</sup>**ZSE 142**

0 040 102 142

VW

06H 905 115 A,  
06H 905 115 BEndstufe<sup>123</sup>**ZSE 137**

0 040 102 137

Audi

06H 905 110 D  
06H 905 110 EEndstufe<sup>123</sup>**ZSE 143**

0 040 102 143

BMW

12 13 7 562 744,  
12 13 7 571 643,  
12 13 7 594 937  
Citroën  
Peugeot597064  
5970.64Endstufe<sup>123</sup>**ZSE 138**

0 040 102 138

Audi

07P 905 715

Zündspule Anschlussausführung  
Sägezahn Endstufe<sup>123</sup>**ZSE 144**

0 040 102 144

BMW

12 13 7 562 745,  
12 13 7 571 644,  
12 13 7 582 627,  
12 13 7 594 935,  
12 13 7 638 477Endstufe<sup>123</sup>



**ZSE 145**  
0 040 102 145

**BMW** 12 13 7 523 345,  
12 13 7 548 553,  
12 13 7 594 936



Endstufe<sup>123</sup>

**ZSE 149**  
0 040 102 149

**Opel** 62 35 124, 91 532 50  
93 172 030



Endstufe<sup>123</sup>

**ZSE 146**  
0 040 102 146

**Mercedes** 000 150 13 80,  
A 000 150 13 80



Endstufe<sup>123</sup>

**ZSE 150**  
0 040 102 150

**Opel** 12 08 213, 90 564 334  
91 958 19



Endstufe<sup>123</sup>

**ZSE 147**  
0 040 102 147

**Opel** 12 08 012, 90 543 253  
90 560 110



Endstufe<sup>123</sup>

**ZSE 151**  
0 040 102 151

**Opel** 62 35 037, 90 424 480,  
91 988 34



Endstufe<sup>123</sup>

**ZSE 148**  
0 040 102 148

**Alfa Romeo** 46794782



Endstufe<sup>123</sup>

**ZSE 152**  
0 040 102 152

**Opel** 12 08 209



Endstufe<sup>123</sup>  
Einbauseite Zylinder 1, 3, 5<sup>130</sup>  
Nur in Verbindung mit ZSE 153 /  
0040102153



**ZSE 153**

0 040 102 153

Opel 12 08 210

Endstufe<sup>123</sup>Einbauseite Zylinder 2, 4, 6<sup>30</sup>Nur in Verbindung mit ZSE 152 /  
0040102152**ZSE 502**

0 040 102 502

ersetzt<sup>263</sup> ZS 262 – 0 040 100 262

Hyundai 27301-38020

mit Endstufe<sup>123</sup>

Hyundai, Kia, Mitsubishi (EU/USA/Korea)

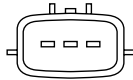
**ZSH 001**

2 040 821 001

Montagehalter für  
Zündspulen<sup>126</sup>

BMW 12 13 2 346 577



BMW F 650 GS

ZS 030 – 0 040 100 030

**ZSH 002**

2 040 821 002

Ford 1315753,  
2S6G 12A376AEHitzeschutzschild für Zündspule<sup>19</sup>  
ZS 350 – 0 040 100 350

Ford



**ZLE 232**

0 300 122 115 (Entstörstecker für Einzelzündspulen<sup>279</sup>)



⚙️ ZS 014, 0 040 100 014

BMW 12 12 1 730 521, 12 13 9 067 831

	EP/ VMQ	↔ 117 mm	Ω 2.000	
		↔ Wavy line		

**ZLE 276**

ersetzt 0 300 122 106

0 300 122 117 (Entstörstecker für Einzelzündspulen<sup>279</sup>)

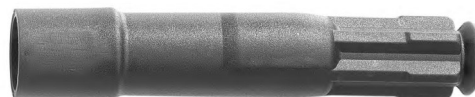

⚙️ ZS 016, 0 040 100 016

Audi, VW 058 905 447 C

	= M5 EP/ VMQ	↔ 112 mm	Ω 2.000	
		↔ Wavy line		

**ZLE 233**

0 300 122 116 (Entstörstecker für Einzelzündspulen<sup>279</sup>)



⚙️ ZS 043, 0 040 100 043

Audi/VW 034 905 447

	EP/ VMQ	↔ 122 mm	Ω 5.000	
		↔ Wavy line		

**ZLE 277**

ersetzt 0 300 122 109

0 300 122 118 (Entstörstecker für Einzelzündspulen<sup>279</sup>)



⚙️ ZS 017, 0 040 100 017

Audi, VW 077 905 447 A

	EP/ VMQ	↔ 133 mm	Ω 2.000	
		↔ Wavy line		

**ZLE 234**

0 300 122 111 (Entstörstecker für Einzelzündspulen<sup>279</sup>)



⚙️ ZS 340, 0 040 100 340

Mercedes-Benz 000 159 35 42, 000 159 36 42

	EP/ VMQ	↔ 113 mm	Ω 2.000	
		↔ Wavy line		

**ZLE 278**

0 300 122 119 (Entstörstecker für Einzelzündspulen<sup>279</sup>)

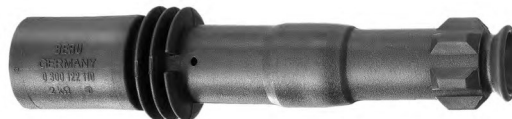

⚙️ ZS 031, 0 040 100 031

Porsche 996 602 103 01

	EP/ VMQ	↔ 117 mm	Ω 2.000	
		↔ Wavy line		

**ZLE 255**

0 300 122 114 (Entstörstecker für Einzelzündspulen<sup>279</sup>)



⚙️ ZS 036, 0 040 100 036

Porsche 996 602 105 00

	EP/ VMQ	↔ 117 mm	Ω 2.000	
		↔ Wavy line		

**ZLE 288**

0 300 122 115 (Entstörstecker für Einzelzündspulen<sup>279</sup>)



⚙️ ZS 309, 0 040 100 309 / ZS 361, 0 040 100 361

Alfa Romeo 717 137 19

	= M5 UP/ Silikon	↔ 102 mm	Ω 2.000	
		↔ Wavy line		

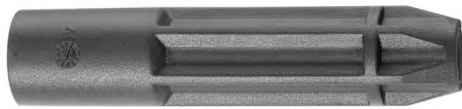
**GS 17**  
0 010 020 022

ZS 041, 0 040 100 041  
Mercedes Benz A 000 159 49 42

VMQ  $\longleftrightarrow$  95 mm**GS 39**  
0 010 020 039

Opel 1612004  
 ZS 259  
Opel

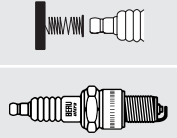
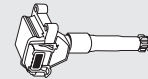
VMQ  $\longleftrightarrow$  90 mm**GS 21**  
0 010 020 021

ZS 053, 0 040 100 053 / ZS 077, 0 040 100 077  
Mercedes Benz

VMQ  $\longleftrightarrow$  55 mm**GS 51**  
0 010 020 051 (in Vorbereitung<sup>210</sup>)

ZS 090  
Alfa Romeo, Fiat (Twin Air Turbo 0,9)

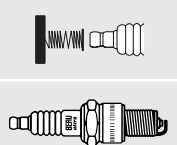
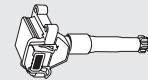
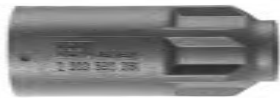
VMQ  $\longleftrightarrow$  135 mm**GS 28**  
0 010 020 028

ZSE 012, 0 040 102 012 / ZSE 042, 0 040 102 042 /  
ZSE 052, 0 040 102 052 / ZSE 054, 0 040 102 054  
Porsche

VMQ  $\longleftrightarrow$  55 mm**GS 29**  
0 010 020 029

ZS 052, 0 040 100 052  
Renault

VMQ  $\longleftrightarrow$  53 mm



### WZ 04-2

0 110 510 007

**Bosch** 0 227 901 012,  
0 227 901 013,  
0 227 901 019,  
0 227 901 020  
**Mercedes Benz** 000 158 13 45,  
000 158 20 45



0,4 Ω  
Anschlussart<sup>170</sup> M 4

Mercedes Benz (Transistorzündung<sup>14</sup>)

### WZ 06-2

0 110 510 033

**Mercedes** 000 158 21 45



0,6 Ω  
Anschlussart<sup>170</sup> M 4

Mercedes Benz

### WZ 09-2

0 110 510 008

**Bosch** 1 224 509 050  
**Mercedes Benz** 000 158 08 45



0,9 Ω  
Anschlussart<sup>170</sup> M 4

Mercedes Benz, ZS 115

### WZ 18-2

0 110 520 001

**Bosch** 0 227 901 014  
**Mercedes Benz** 000 158 17 45  
000 158 18 45



1,8 Ω  
Anschlussart<sup>170</sup> M 4

Mercedes Benz, ZS 109, ZS 110

### WZR 09 KF

0 110 510 010

**Bosch** 0 227 900 006



0,9 Ω  
Anschlussart<sup>170</sup> A 6,3 x 8,8 mm

VW AG

**ZA 500**  
0 040 200 500

Bosch 2204210013



 Batavus, Claeys, Moto-Guzzi, Steyr-Daimler-Puch, Tomos

Anschlussleitung<sup>194</sup>  
70 mm

**ZA 501**  
0 040 200 501

Bosch 2204211030



 Claeys, DKW, Herkules, Kreidler, Steyr-Daimler-Puch, Zündapp

Anschlussleitung<sup>194</sup>  
70 mm

**ZA 503**  
0 040 200 503

Bosch 2212940001



 Agrati-Garelli, Batavus, Cyrus, DKW, Herkules, Kreidler, Laverda, Maico, Metalurgia Casal, Motobecane, Odyssee, Steyr-Daimler-Puch, Tomos, Zündapp

**ZA 509**  
0 040 200 509

Bosch 2204211045



 Kreidler, KTM, Hercules

Anschlussleitung<sup>194</sup>  
80 mm

**ZA 510**  
0 040 200 510

Bosch 2204211043



 Agrati-Garelli, Batavus, Claeys, Flandria, DKW, Hercules, Solo, Kreidler, Rixe, Zündapp

Anschlussleitung<sup>194</sup>  
40 mm

**D**

**Werkzeug zur Montage und Demontage von Steckerzündspulen mit Leistungsendstufe**

- ZSA 044 Zündspulen mit ovaler Gehäuseform
- ZSA 042 Zündspulen mit eckiger Gehäuseform
- ZSA 043 Zündspulen mit flacher Gehäuseform

**GB USA**

**Tool for assembly and disassembly of spark plug shaft ignition coils with final power stage**

- ZSA 044 Ignition coils with oval housing
- ZSA 042 Ignition coils with angular housing
- ZSA 043 ignition coils with flat housing

**F**

**Outil de montage et démontage de bobines d'allumage crayons avec étage final de puissance**

- Bobines d'allumage ZSA 044 avec boîtier ovale
- Bobines d'allumage ZSA 042 avec boîtier rectangulaire
- Bobines d'allumage ZSA 043 avec boîtier plat

**NL**

**Gereedschap voor de montage en demontage van staaftbobines met vermogenseindtrap.**

- ZSA 044 Bobines met ovale behuizingvorm
- ZSA 042 Bobines met hoekige behuizingvorm
- ZSA 043 Bobines met vlakke behuizingvorm

**E**

**Herramienta para el montaje y desmontaje de bobinas de encendido en forma de lápiz con paso final de potencia**

- ZSA 044 Bobinas de encendido de forma ovalada
- ZSA 042 Bobinas de encendido de forma angular
- ZSA 043 Bobinas de encendido de forma plana

**I**

**Utensile per il montaggio e lo smontaggio di bobine d'accensione nel vano candela con fase finale di potenza**

- ZSA 044 bobine d accensione con alloggiamento di forma ovale
- ZSA 042 bobine d accensione con alloggiamento ad angoli
- ZSA 043 bobine d accensione con alloggiamento piatto

**GUS**

**Инструмент для монтажа и демонтажа катушек зажигания с гнездом для свечи и выходным каскадом мощности**

- ZSA 044 Катушки зажигания с корпусом овальной формы
- ZSA 042 Катушки зажигания с корпусом прямоугольной формы
- ZSA 043 Катушки зажигания с корпусом

**PL**

**Narzędzia do montażu i demontażu indywidualnych cewek zapłonowych ze wzmacniaczem mocy**

- ZSA 044 cewki zapłonowe w obudowie owalnej
- ZSA 042 cewki zapłonowe w obudowie prostokątnej
- ZSA 043 cewki zapłonowe w obudowie płaskiej

**GR**

**Εργαλεία για τη συναρμολόγηση και αποσυναρμολόγηση πηνίων ανάφλεξης για υποδοχή μπουζί με τελική βαθμίδα ισχύος**

- ZSA 044 Πηνία ανάφλεξης με οβάλ σχήμα περιβλήματος
- ZSA 042 Πηνία ανάφλεξης με γωνιώδες σχήμα περιβλήματος
- ZSA 043 Πηνία ανάφλεξης με επίπεδο

**HU**

**Teljesítmény-végfokozattal rendelkező gyertyaakna gyújtótekerccsek beszereléséhez és kiszerezéséhez való szerszámok**

- ZSA 044 ovális házú gyújtótekerccsek
- ZSA 042 szögletes házú gyújtótekerccsek
- ZSA 043 lapos házú gyújtótekerccsek

**ZSA 042**

0 890 300 042

Audi/VW 03D 905 115 F,  
07C 905 115 C/-J,  
022 905 100 J,  
036 905 715 E,  
066 905 100 D,  
07C 905 715  
ZSE 030/0 040 102 030  
ZSE 031/0 040 102 031  
ZSE 059/0 040 102 059  
ZSE 065/0 040 102 065



**ZSA 043**

0 890 300 043

Audi/VW 022 905 100 N/-S  
022 905 715  
ZSE 041/0 040 102 041  
ZSE 044/0 040 100 044  
ZSE 063/0 040 100 063



**ZSA 044**

0 890 300 044

Audi/VW 06B 905 115 R  
06C 905 115 L  
06D 905 115 K  
06F 905 115 F  
077 905 115 F/-Q/-S  
06E 905 115  
07K 908 715  
ZSE 032/0 040 102 032  
ZSE 033/0 040 102 033  
ZSE 043/0 040 102 043  
ZSE 051/0 040 102 051  
ZSE 061/0 040 102 061  
ZSE 062/0 040 102 062



**P**

**Ferramenta para a montagem e desmontagem de bobinas de ignição no compartimento das velas com estágio final de potência**

- bobinas de ignição ZSA 044 com estrutura oval
- bobinas de ignição ZSA 042 com estrutura angular
- bobinas de ignição ZSA 043 com estrutura plana

**TR**

**Güç çıkış katı bulunan buji yuvalı ateşleme bobinlerini sökme ve takma için alet**

- ZSA 044 Oval gövde formulu ateşleme bobinleri
- ZSA 042 Köşeli gövde formulu ateşleme bobinleri
- ZSA 043 Düz gövde formulu ateşleme bobinleri



<b>ACURA</b>	ZS 278
<b>ALFA ROMEO</b>	ZM 001, ZM 003, ZM 005, ZM 026, ZM 035, ZM 037, ZS 079, ZS 095, ZS 106, ZS 115, ZS 122, ZS 230, ZS 234, ZS 283, ZS 309, ZS 322, ZS 361, ZS 427, ZS 428, ZSE 148
<b>ALPINA</b>	ZS 302
<b>ALPINE</b>	ZS 110, ZS 251, ZS 400
<b>ASTON MARTIN</b>	ZM 047, ZS 389, ZS 426
<b>AUDI</b>	ZM 001, ZM 002, ZM 012, ZM 027, ZM 028, ZM 030, ZM 031, ZM 062, ZM 063, ZS 012, ZS 016, ZS 017, ZS 043, ZS 106, ZS 120, ZS 124, ZS 280, ZSE 001, ZSE 002, ZSE 003, ZSE 005, ZSE 006, ZSE 007, ZSE 008, ZSE 009, ZSE 030, ZSE 031, ZSE 032, ZSE 033, ZSE 036, ZSE 041, ZSE 043, ZSE 044, ZSE 051, ZSE 061, ZSE 062, ZSE 067, ZSE 068, ZSE 126, ZSE 137, ZSE 138, ZSE 142
<b>AUSTIN</b>	ZS 106
<b>BMW</b>	ZM 001, ZM 038, ZS 014, ZS 121, ZS 122, ZS 302, ZS 307, ZS 324, ZS 400, ZSE 143, ZSE 144, ZSE 145
<b>BUICK</b>	ZS 508
<b>CADILLAC</b>	ZSE 152, ZSE 153
<b>CHEVROLET</b>	ZS 379, ZS 395, ZS 508, ZSE 133
<b>CHRYSLER</b>	ZS 379, ZS 380, ZS 392, ZS 405, ZS 406, ZS 431, ZS 432
<b>CITROËN</b>	ZM 001, ZM 003, ZM 015, ZM 026, ZS 106, ZS 115, ZS 231, ZS 232, ZS 234, ZS 241, ZS 247, ZS 249, ZS 256, ZS 257, ZS 258, ZS 323, ZS 341, ZS 343, ZS 346, ZS 347, ZS 348, ZS 349, ZS 351, ZS 352, ZS 381, ZSE 045, ZSE 046, ZSE 047, ZSE 048, ZSE 143
<b>DACIA</b>	ZS 052, ZS 106, ZS 325, ZS 354, ZSE 131
<b>DAEWOO</b>	ZS 340, ZS 508
<b>DAIHATSU</b>	ZM 053, ZS 109, ZS 110
<b>DAIMLER</b>	ZS 126
<b>DODGE</b>	ZS 431, ZS 432
<b>FERRARI</b>	ZM 026, ZM 061, ZS 234, ZSE 127, ZSE 128
<b>FIAT</b>	ZM 001, ZM 005, ZM 009, ZM 017, ZM 026, ZM 043, ZM 061, ZS 029, ZS 079, ZS 090, ZS 095, ZS 106, ZS 115, ZS 230, ZS 232, ZS 234, ZS 244, ZS 248, ZS 283, ZS 310, ZS 311, ZS 320, ZS 321, ZS 322, ZS 341, ZS 347, ZS 349, ZS 427, ZSE 048
<b>FORD</b>	ZM 003, ZM 008, ZM 015, ZM 019, ZM 020, ZM 047, ZS 079, ZS 126, ZS 237, ZS 238, ZS 239, ZS 281, ZS 308, ZS 350, ZS 360, ZS 365, ZS 369, ZS 371, ZS 372, ZS 387, ZS 408, ZS 410, ZS 422, ZSE 004, ZSE 055, ZSE 089
<b>FORD USA</b>	ZS 281, ZS 366, ZS 369, ZS 370, ZS 371
<b>FSO</b>	ZM 005, ZS 106, ZS 234
<b>HONDA</b>	ZM 016, ZM 023, ZM 045, ZM 054, ZM 055, ZM 056, ZS 106, ZS 275, ZS 276, ZS 278, ZS 417, ZS 419, ZS 532
<b>HUMMER</b>	ZSE 133
<b>HYUNDAI</b>	ZM 035, ZM 049, ZS 261, ZS 263, ZS 264, ZS 266, ZS 267, ZS 269, ZS 502, ZS 511, ZS 521, ZS 522, ZS 536, ZSE 011, ZSE 086, ZSE 087, ZSE 502
<b>INFINITI</b>	ZM 048, ZS 269, ZS 277, ZSE 071, ZSE 073, ZSE 074, ZSE 075, ZSE 076, ZSE 077, ZSE 078, ZSE 132
<b>ISUZU</b>	ZS 355, ZSE 133
<b>JAGUAR</b>	ZS 126, ZS 367, ZS 368
<b>JEEP</b>	ZS 251, ZS 380, ZS 393, ZS 394, ZS 396
<b>KIA</b>	ZS 234, ZS 269, ZS 433, ZS 434, ZS 436, ZS 511, ZS 521, ZSE 086, ZSE 087, ZSE 502
<b>LADA</b>	ZM 010, ZM 039, ZS 106, ZS 115, ZS 120, ZS 234, ZS 395
<b>LANCIA</b>	ZM 005, ZM 009, ZM 017, ZM 026, ZM 040, ZM 061, ZS 029, ZS 079, ZS 090, ZS 095, ZS 106, ZS 115, ZS 119, ZS 230, ZS 234, ZS 244, ZS 248, ZS 283, ZS 310, ZS 311, ZS 322, ZS 341, ZS 347, ZS 428
<b>LANDROVER</b>	ZM 047, ZS 106, ZS 109, ZS 117, ZS 234, ZS 435, ZS 437, ZS 501
<b>LINCOLN</b>	ZS 367, ZS 368, ZS 369
<b>LOTUS</b>	ZS 502



<b>MAZDA</b>	ZM 022, ZM 024, ZM 025, ZM 050, ZS 052, ZS 237, ZS 239, ZS 274, ZS 279, ZS 281, ZS 350, ZS 387, ZS 410, ZS 422, ZSE 083, ZSE 084
<b>MERCEDES-BENZ</b>	ZM 004, ZM 040, ZS 041, ZS 053, ZS 077, ZS 106, ZS 109, ZS 117, ZS 118, ZS 296, ZS 297, ZS 298, ZS 299, ZS 313, ZS 339, ZS 340, ZS 400, ZSE 004, ZSE 140, ZSE 146
<b>MG</b>	ZS 088, ZS 501, ZS 502
<b>MINI</b>	ZS 382, ZSE 143
<b>MITSUBISHI</b>	ZM 022, ZM 049, ZM 051, ZM 053, ZS 106, ZS 110, ZS 115, ZS 261, ZS 263, ZS 264, ZS 282, ZS 511, ZS 521, ZSE 010
<b>NISSAN</b>	ZM 048, ZM 049, ZS 052, ZS 106, ZS 109, ZS 110, ZS 115, ZS 277, ZS 337, ZS 354, ZS 376, ZS 511, ZSE 021, ZSE 056, ZSE 071, ZSE 073, ZSE 074, ZSE 075, ZSE 076, ZSE 077, ZSE 078, ZSE 079, ZSE 080, ZSE 081, ZSE 082, ZSE 088, ZSE 132, ZSE 134
<b>OPEL</b>	ZM 001, ZM 002, ZM 006, ZM 007, ZM 015, ZM 016, ZM 018, ZM 026, ZM 032, ZM 034, ZM 041, ZS 052, ZS 125, ZS 127, ZS 252, ZS 253, ZS 259, ZS 300, ZS 301, ZS 306, ZS 338, ZS 342, ZS 344, ZS 355, ZS 358, ZS 359, ZS 427, ZS 450, ZS 451, ZSE 026, ZSE 147, ZSE 149, ZSE 150, ZSE 151, ZSE 152, ZSE 153
<b>PEUGEOT</b>	ZM 001, ZM 003, ZM 015, ZM 026, ZS 106, ZS 110, ZS 119, ZS 231, ZS 232, ZS 241, ZS 247, ZS 249, ZS 256, ZS 257, ZS 258, ZS 323, ZS 343, ZS 347, ZS 348, ZS 349, ZS 351, ZS 352, ZS 353, ZS 381, ZSE 045, ZSE 046, ZSE 047, ZSE 048, ZSE 143
<b>PININFARINA</b>	ZS 106, ZS 115
<b>PLYMOUTH</b>	ZS 405
<b>PORSCHE</b>	ZM 015, ZM 026, ZS 031, ZS 036, ZS 115, ZS 122, ZS 298, ZS 357, ZSE 012, ZSE 032, ZSE 042, ZSE 044, ZSE 052, ZSE 054
<b>PROTON</b>	ZS 438
<b>PUCH</b>	ZS 297, ZS 340
<b>RENAULT</b>	ZM 005, ZM 036, ZM 052, ZS 052, ZS 106, ZS 110, ZS 115, ZS 242, ZS 243, ZS 245, ZS 246, ZS 250, ZS 251, ZS 254, ZS 255, ZS 315, ZS 316, ZS 317, ZS 318, ZS 319, ZS 325, ZS 338, ZS 343, ZS 345, ZS 347, ZS 354, ZS 375, ZSE 037, ZSE 066, ZSE 088, ZSE 131
<b>ROLLS-ROYCE</b>	ZS 324, ZSE 143
<b>ROVER</b>	ZM 023, ZM 044, ZM 047, ZS 088, ZS 106, ZS 115, ZS 231, ZS 275, ZS 276, ZS 435, ZS 437, ZS 501, ZS 502, ZS 532
<b>SAAB</b>	ZM 001, ZM 002, ZM 012, ZM 015, ZM 029, ZS 121, ZS 127, ZS 301, ZS 342, ZSE 133
<b>SEAT</b>	ZM 002, ZM 012, ZM 013, ZM 015, ZM 062, ZS 016, ZS 037, ZS 106, ZS 120, ZS 124, ZS 327, ZSE 001, ZSE 002, ZSE 003, ZSE 009, ZSE 013, ZSE 030, ZSE 033, ZSE 040, ZSE 043, ZSE 059, ZSE 063, ZSE 067, ZSE 068, ZSE 126, ZSE 142
<b>SKODA</b>	ZM 060, ZM 062, ZS 016, ZS 106, ZS 109, ZSE 001, ZSE 003, ZSE 029, ZSE 030, ZSE 033, ZSE 039, ZSE 040, ZSE 041, ZSE 043, ZSE 044, ZSE 059, ZSE 067, ZSE 126, ZSE 140, ZSE 142
<b>SMART</b>	ZS 304
<b>SSANGYONG</b>	ZS 340, ZS 537
<b>SUBARU</b>	ZM 046
<b>SUZUKI</b>	ZM 024, ZS 110, ZS 274, ZSE 069, ZSE 072, ZSE 136
<b>TALBOT</b>	ZM 001
<b>TOYOTA</b>	ZM 057, ZM 058, ZM 059, ZS 110, ZS 356, ZS 430, ZS 449
<b>TRABANT</b>	ZS 106
<b>TRIUMPH</b>	ZM 054
<b>TVR</b>	ZM 047
<b>UAZ</b>	ZS 535
<b>VAUXHALL</b>	ZM 002, ZM 006, ZM 007, ZM 018, ZM 026, ZM 032, ZM 034, ZS 052, ZS 125, ZS 127, ZS 253, ZS 259, ZS 300, ZS 301, ZS 306, ZS 338, ZS 342, ZS 344, ZS 355, ZS 358, ZS 359, ZS 427
<b>VOLVO</b>	ZM 002, ZM 015, ZM 033, ZM 036, ZM 039, ZM 040, ZS 106, ZS 115, ZS 119, ZS 120, ZS 245, ZS 246, ZS 251, ZS 254, ZS 255, ZS 387, ZS 429, ZSE 019, ZSE 037, ZSE 055
<b>VW AG</b>	ZM 002, ZM 012, ZM 013, ZM 014, ZM 028, ZM 062, ZS 016, ZS 037, ZS 106, ZS 115, ZS 120, ZS 123, ZS 124, ZS 314, ZS 340, ZSE 001, ZSE 002, ZSE 003, ZSE 004, ZSE 006, ZSE 009, ZSE 013, ZSE 029, ZSE 030, ZSE 031, ZSE 032, ZSE 033, ZSE 040, ZSE 041, ZSE 043, ZSE 044, ZSE 059, ZSE 062, ZSE 063, ZSE 065, ZSE 067, ZSE 068, ZSE 126, ZSE 142
<b>WARTBURG</b>	ZM 012, ZS 106, ZS 124
<b>ZASTAVA</b>	ZM 001, ZM 029, ZS 106



<b>Agrati-Garelli</b>	ZA 503, ZA 510
<b>Batavus</b>	ZA 503, ZA 510
<b>BENELLI</b>	ZS 377
<b>BMW</b>	ZS 030, ZS 224, ZS 227, ZS 383, ZS 384, ZS 385, ZS 386
<b>Claeys</b>	ZA 500, ZA 501, ZA 510
<b>Cyrus</b>	ZA 503
<b>DKW</b>	ZA 501, ZA 503, ZA 510
<b>DUCATI</b>	ZS 054, ZS 056, ZS 085, ZS 284, ZS 507
<b>Flandria</b>	ZA 510
<b>Hercules</b>	ZA 509, ZA 510
<b>Herkules</b>	ZA 501, ZA 503
<b>Kreidler</b>	ZA 501, ZA 503, ZA 509, ZA 510
<b>KTM</b>	ZA 509
<b>Laverda</b>	ZA 503
<b>Maico</b>	ZA 503
<b>Metalurgia Casal</b>	ZA 503
<b>Motobecane</b>	ZA 503
<b>Moto-Guzzi</b>	ZA 500
<b>Odysee</b>	ZA 503
<b>PERKINS</b>	ZS 049
<b>Rixe</b>	ZA 510
<b>Steyr-Daimler-Puch</b>	ZA 500, ZA 501, ZA 503
<b>Solo</b>	ZA 510
<b>Tomos</b>	ZA 500, ZA 503
<b>VESPA</b>	ZS 078
<b>Zündapp</b>	ZA 501, ZA 503, ZA 509

**D Wichtiger Hinweis**

Diese Vergleichsliste ist nur eine Orientierungshilfe. Benützen Sie die aktuellen BERU Verwendungslisten um das verbindliche Produkt festzustellen. Eine Rückumschlüsselung von BERU zu Fremdtypen ist nicht erlaubt. Aus einer falschen Umschlüsselung können keine Gewährleistungsansprüche abgeleitet werden.

**GB USA Important note**

This comparison list is only an aid. Refer to the current BERU application lists to find the binding product. Reverse conversion from BERU to types from other manufacturers is not permitted. No liability claims can be derived from an incorrect conversion.

**F Important**

Cette liste comparative vous est donnée à titre indicatif. Pour déterminer le produit adéquat, veuillez vous référer aux listes d'affectations BERU en vigueur. L'utilisation de la liste d'équivalences dans l'autre sens (de BERU vers les autres marques) n'est pas possible. Une conversion erronée rend tout droit à la garantie caduque.

**NL Waarschuwing**

Deze vergelijkingslijst is slechts bedoeld als oriënteringhulp. Gebruik de actuele BERU-toepassingslijsten om het goedgekeurde product vast te stellen. Terugomzetten van BERU naar types van andere fabrikanten is niet toegestaan. Er kunnen geen garantieaanspraken afgeleid worden van een verkeerde omzetting.

**E Nota importante**

Esta lista comparativa sirve únicamente como referencia. Utilice las listas de aplicación actuales de BERU para determinar el producto adecuado. No se permite el uso inverso de la lista de equivalencias (de BERU a otras marcas). De una conversión errónea no se puede derivar ningún tipo de derechos de garantía.

**I Indicazione importante**

Questa lista di confronto serve solo a scopo di riferimento. Per definire in maniera vincolante il prodotto giusto utilizzate le liste di applicazione BERU più attuali. La riconversione dei codici BERU in codici di altri produttori non è ammessa. In caso di errori nella conversione dei codici decade qualsiasi diritto di garanzia.

**RUS Важное указание!**

Настоящий перечень сравнительных данных представляет собой лишь вспомогательное средство для ориентации. Следует использовать актуальный перечень фирмы BERU с описанием применений с тем, чтобы определить продукт, связанный гарантийными обязательствами. Не разрешается перекодирование BERU в другой тип. Неправильное перекодирование исключает право на гарантийные обязательства.

**PL Ważne zalecenie:**

Niniejsza lista porównawcza stanowi jedynie pomoc orientacyjną. W celu ustalenia obowiązującego produktu należy stosować aktualne listy zastosowań wyrobów firmy BERU. Niedozwolone jest wtórne zastępowanie wyrobów firmy BERU wyrobami innych firm. Nieprawidłowe zastąpienie powoduje przypadek rozszczeń gwarancyjnych.

**GR Σημαντική υπόδειξη**

Αυτός ο κατάλογος σύγκρισης αποτελεί μόνο βοήθεια προσανατολισμού. Για να εξακριβώσετε το αυθεντικό προϊόν χρησιμοποιήστε τους επίκαιρους καταλόγους χρήσης της BERU. Δεν επιτρέπεται η διακωδικοποίηση από προϊόντα της BERU σε προϊόντα ξένων κατασκευαστών. Από εσφαλμένη διακωδικοποίηση δεν μπορούν να συναχθούν εγγυητικές αξιώσεις.

**H Fontos figyelmeztetés**

Ez az összehasonlító lista kizárólag a tájékozódást segíti. A megfelelő termék kiválasztásához használja a BERU aktuális alkalmazási listáit. A BERU típusait nem szabad más gyártók típusaival helyettesíteni. Téves behelyettesítésből nem vezethet le jóállási igényt.

**P Aviso importante**

Esta lista de comparação é apenas uma ajuda de orientação. Utilize as listas de aplicação atuais para determinar o produto a usar. Não é permitida uma reconversão de Beru para outros modelos de terceiros. As conversões erradas não podem dar origem a pedidos de garantia.

**TR Önemli bilgi**

Bu karşılaştırma listesi sadece bir oryantasyon yardımıdır. Bağlayıcı ürünü belirlemek için güncel Beru kullanım listelerini kullanınız. Beru'dan harici tiplere geriye dönük kod dönüştürme işlemine izin verilmez. Yanlış bir kod dönüştürme işlemi nedeniyle hiçbir garanti talebinde bulunulamaz.

AGRIA	BERU
1137 42 597 1	ZS 106

AIRTEX	BERU
5C 1071	ZSE 136
5C 1092	ZS 431
5C 1095	ZS 405
5C 1153	ZS 521
5C 1157	ZS 522
5C 1159	ZSE 086
5C 1163	ZSE 077
5C 1165	ZSE 071
5C 1166	ZSE 073
5C 1171	ZSE 074
5C 1208	ZSE 083
5C 1241	ZSE 076
5C 1287	ZSE 072
5C 1317	ZS 429
5C 1394	ZSE 081
5C 1396	ZS 437
5C 1397	ZS 435
5C 1403	ZSE 079
5C 1428	ZSE 087
5C 1430	ZSE 132
5C 1488	ZS 430
5C 16127	ZSE 080

ALFA ROMEO	BERU
105266507900	ZS 106
116556507900/00	ZS 115
116556507901/00	ZS 115
116976507900	ZM 001
116976507901	ZM 001
46467542	ZS 311
46469863	ZS 309
46755605	ZS 361
46794782	ZSE 148
510897	ZS 106
542162000000	ZM 001
60564142	ZS 230
605042880	ZM 001
605229970	ZM 001
60558152	ZS 234
60562701	ZS 428
60586072	ZS 234
60805420	ZS 283
60809492	
60809606	ZS 234
71716152	ZS 119
71739725	ZS 427
7648797	ZS 234
76487970	ZS 234

ANGLI INDUSTRIAS S.A.	BERU
15067	ZS 375
15138	ZS 376

APRILIA	BERU
640695	ZSE 130

ASTON MARTIN	BERU
4G43-12A366-BA	ZS 388
4G4E-12A366-AA	ZS 426
6G33-12A366-CA	ZS 389
8G43-12A366-AA	ZS 388
9G33-12A366-AA	ZS 389

AUDI VW AG	BERU

AURADIA	BERU
21724	ZS 052

AUSTIN	BERU
BAU 5100	ZM 047
BAU 5332	ZM 001
BAU 5538	ZM 047
RTC 5089	ZM 047

AUTOMEGA	BERU
3012080071	ZS 344
3012080306	ZS 358
3012080307	ZS 259

BBT	BERU
16104	ZSE 071
IC01101	ZSE 055
IC02100	ZS 357
IC02101	ZS 031
IC03100	ZSE 001
IC03101	ZSE 030
IC03102	ZSE 043
IC03104	ZSE 003
IC03105	ZS 123
IC03105	ZS 124
IC03106	ZS 016
IC03107	ZS 017
IC03109	ZSE 002
IC03110	ZSE 142
IC03111	ZSE 032
IC03112	ZSE 031
IC03114	ZSE 039
IC03114	ZSE 040
IC03118	ZSE 063
IC03119	ZSE 029
IC03121	ZSE 051
IC03122	ZSE 059
IC03123	ZSE 044
IC03127	ZSE 067
IC03127	ZSE 126
IC03128	ZSE 137
IC03128	ZSE 068
IC04101	ZS 313
IC04102	ZS 340
IC04104	ZS 339
IC04105	ZS 298
IC04108	ZS 340
IC04110	ZSE 146
IC04112	ZS 053
IC04114	ZSE 140
IC07100	ZS 344
IC07102	ZS 259
IC07103	ZS 252
IC07104	ZSE 026
IC07105	ZS 342
IC07106	ZS 358
IC07107	ZSE 147
IC07108	ZSE 151
IC07109	ZS 427
IC07113	ZS 451
IC07114	ZS 450
IC07116	ZSE 152
IC07117	ZSE 153
IC07121	ZSE 150
IC07122	ZS 359
IC09100	ZS 014
IC09102	ZS 014
IC09103	ZS 302
IC09107	ZS 324
IC10101	ZS 309
IC10104	ZSE 148
IC12102	ZS 088
IC13100	ZS 283
IC13101	ZS 244
IC13102	ZS 248
IC13105	ZS 029
IC13106	ZS 320
IC13108	ZS 361
IC13116	ZS 095
IC15100	ZS 052
IC15101	ZS 231
IC15103	ZS 341
IC15103	ZS 232
IC15105	ZS 256
IC15108	ZS 242
IC15110	ZS 257
IC15111	ZS 249
IC15112	ZS 250
IC15113	ZS 317
IC15114	ZS 258
IC15116	ZS 255
IC15117	ZS 243
IC15118	ZS 315

BBT	BERU
IC15119	ZS 345
IC15120	ZS 354
IC15123	ZS 346
IC15125	ZS 347
IC15126	ZSE 045
IC15127	ZSE 046
IC15128	ZS 348
IC15129	ZS 351
IC15130	ZS 352
IC15131	ZS 353
IC15138	ZSE 066
IC16100	ZS 276
IC16101	ZS 275
IC16102	ZS 263
IC16103	ZSE 073
IC16105	ZSE 082
IC16109	ZSE 072
IC16110	ZS 433
IC16112	ZSE 081
IC16113	ZSE 056
IC16117	ZS 521
IC16127	ZSE 080
IC16128	ZSE 088
IC17100	ZS 279
IC17101	ZSE 011
IC17102	ZS 356
IC17114	ZSE 502
IC17124	ZSE 083
IC17125	ZSE 084
IC18100	ZS 281
IC18101	ZS 350
IC18106	ZS 387
ZK15102	ZSE 047
ZK15106	ZSE 047
ZK15132	ZSE 048

BENELLI	BERU
0500033012000	ZS 377
R 500033012000	ZS 377

BMW	BERU
0 495 289	ZS 324
1 247 281	ZS 307
1 286 087	ZS 122
1 404 309	ZS 302
1 703 227	ZS 302
1 703 825	ZS 302
1 712 219	ZS 324
1 712 223	ZS 324
1 720 166	ZS 014
1 726 176	ZS 014
1 726 177	ZS 014
1 726 178	ZS 014
1 726 178 B	ZS 014
1 730 765	ZS 014
1 731 134 B	ZS 014
1 731 178 B	ZS 014
1 748 017	ZS 302
1 748 018	ZS 302
1 748 394	ZS 014
1 777 666	ZS 014
12 13 0 495 289	ZS 324
12 13 1 247 281	ZS 307
12 13 1 286 087	ZS 122
12 13 1 326 684	ZS 115
12 13 1 341 978	ZS 224
12 13 1 350 051	ZS 106
12 13 1 357 240	ZS 109
12 13 1 357 294	ZS 115
12 13 1 357 295	ZS 115
12 13 1 357 296	ZS 106
12 13 1 359 637	ZS 106
12 13 1 363 629	ZS 400
12 13 1 402 440	ZS 014
12 13 1 402 713	ZS 014
12 13 1 703 227	ZS 302
12 13 1 703 228	ZS 302
12 13 1 703 359	ZS 014
12 13 1 703 825	ZS 302
12 13 1 712 219	ZS 324
12 13 1 712 223	ZS 324
12 13 1 720 166	ZS 014

BMW	BERU
12 13 1 726 176	ZS 014
12 13 1 726 177	ZS 014
12 13 1 726 178	ZS 014
12 13 1 729 842	ZS 014
12 13 1 730 765	ZS 014
12 13 1 731 134	ZS 014
12 13 1 731 884	ZS 014
12 13 1 748 017	ZS 302
12 13 1 748 018	ZS 302
12 13 1 748 394	ZS 014
12 13 1 777 666	ZS 014
12 13 2 306 330	ZS 224
12 13 2 346 570	ZS 030
12 13 4 645 117	ZS 386
12 13 7 510 738	ZS 382
12 13 7 523 345	ZSE 145
12 13 7 548 553	ZSE 145
12 13 7 551 260	ZS 324
12 13 7 562 744	ZSE 143
12 13 7 562 745	ZSE 144
12 13 7 571 643	ZSE 143
12 13 7 571 644	ZSE 144
12 13 7 582 627	ZSE 144
12 13 7 594 935	ZSE 144
12 13 7 594 936	ZSE 145
12 13 7 594 937	ZSE 143
12 13 7 638 477	ZSE 144
12 13 7 670 815	ZS 386
12 13 7 703 359	ZS 014
12 13 7 709 080	ZS 386
12 13 7 715 846	ZS 386
12 13 7 841 558	ZS 324
12 13 8 630 004	ZS 106
12 13 8 730 002	ZS 115
12 13 9 066 468	ZS 014
12 14 1 244 089	ZM 002
12 14 1 244 191	ZM 002
12 14 1 244 226	ZM 002
12 14 1 244 477	ZM 002
12 14 1 244 478	ZM 002
12 14 1 244 481	ZM 002
12 14 1 266 702	ZM 001
12 14 1 273 203	WZ 04-2
12 14 1 273 204	WZ 04-2
12 14 1 273 205	WZ 04-2
12 14 1 273 217	ZM 001
12 14 1 273 298	ZM 001
12 14 1 274 698	ZM 001
12 14 1 287 757	ZM 038
12 14 1 360 672	ZS 400
12 14 1 360 675	ZS 400
12 14 1 363 170	WZ 04-2
12 14 1 461 441	ZM 026
12 14 1 705 607	ZM 038
12 14 1 705 608	ZM 038
12 14 1 706 439	ZM 038
4 645 117	ZS 386
7 551 260	ZS 324
7 670 815	ZS 386
7 671 896	ZS 385
7 676 572	ZS 384
7 680 644	ZS 385
7 692 262	ZS 384
7 696 510	ZS 384
7 698 929	ZS 383
7 709 080	ZS 386
7 715 846	ZS 386
7 715 853	ZS 385
7 715 856	ZS 384
7 715 857	ZS 383
7 841 558	ZS 324
8 520 154	ZS 385
8 520 173	ZS 383
8 520 174	ZS 384

BOSCH	BERU
0 221 100 053	ZS 109
0 221 101 001	ZS 105
0 221 101 003	ZS 106
0 221 101 005	ZS 105
0 221 101 007	ZS 105
0 221 101 010	ZS 105
0 221 101 014	ZS 105

BOSCH	BERU	BOSCH	BERU	BOSCH	BERU	BOSCH	BERU
0 221 101 016	ZS 106	0 221 122 010	ZS 400	0 221 505 423	ZS 308	0 986 221 000	ZSE 001
0 221 101 027	ZS 105	0 221 122 030	ZS 126	0 221 505 437	ZS 313	0 986 221 001	ZS 052
0 221 101 029	ZS 105	0 221 122 031	ZS 126	0 221 506 002	ZS 340	0 986 221 002	ZSE 002
0 221 101 030	ZS 105	0 221 122 304	ZS 120	0 221 506 453	ZS 360	0 986 221 003	ZS 029
0 221 102 001	ZS 106	0 221 122 323	ZS 120	0 221 600 002	ZM 001	0 986 221 004	ZS 264
0 221 102 003	ZS 106	0 221 122 327	ZS 121	0 221 600 009	ZS 120	0 986 221 005	ZS 266
0 221 102 012	ZS 106	0 221 122 334	ZS 120	0 221 600 011	ZS 123	0 986 221 006	ZSE 011
0 221 102 016	ZS 106	0 221 122 349	ZS 124	0 221 600 014	ZM 001	0 986 221 007	ZS 041
0 221 102 017	ZS 106	0 221 122 357	ZS 120	0 221 600 015	ZM 001	0 986 221 008	ZS 267
0 221 102 031	ZS 115	0 221 122 362	ZS 126	0 221 600 016	ZM 001	0 986 221 009	ZS 017
0 221 102 032	ZS 106	0 221 122 399	ZS 123	0 221 600 017	ZM 001	0 986 221 010	ZS 263
0 221 102 036	ZS 115	0 221 122 402	ZS 125	0 221 600 052	ZM 001	0 986 221 011	ZS 016
0 221 102 037	ZS 106	0 221 122 403	ZS 125	0 221 600 055	ZM 029	0 986 221 012	ZS 261
0 221 102 038	ZS 106	0 221 122 408	ZS 127	0 221 601 001	ZSE 002	0 986 221 014	ZS 043
0 221 102 041	ZS 106	0 221 122 409	ZS 127	0 221 601 002	ZSE 002	0 986 221 015	ZSE 004
0 221 102 044	ZS 106	0 221 122 418	ZS 123	0 221 601 003	ZSE 001	0 986 221 016	ZS 031
0 221 102 045	ZS 106	0 221 122 446	ZS 109	0 221 601 004	ZSE 001	0 986 221 017	ZS 037
0 221 102 046	ZS 115	0 221 122 450	ZS 126	0 221 601 005	ZSE 001	0 986 221 018	ZSE 502
0 221 102 049	ZS 106	0 221 124 001	ZS 105	0 221 601 012	ZSE 037	0 986 221 020	ZS 269
0 221 102 051	ZS 115	0 221 500 001	ZS 224	0 221 603 009	ZSE 003	0 986 221 022	ZSE 010
0 221 102 052	ZS 106	0 221 500 459	ZS 224	0 221 603 010	ZSE 003	0 986 221 023	ZSE 030
0 221 102 053	ZS 109	0 221 501 003	ZS 296	0 221 604 001	ZSE 019	0 986 221 024	ZSE 043
0 221 102 055	ZS 106	0 221 501 007	ZS 339	0 221 604 008	ZSE 019	0 986 221 025	ZS 242
0 221 102 056	ZS 106	0 221 501 374	ZS 298	0 221 604 010	ZSE 055	0 986 221 026	ZS 243
0 221 102 058	ZS 106	0 221 501 376	ZS 299	0 221 604 014	ZSE 056	0 986 221 027	ZS 244
0 221 102 059	ZS 106	0 221 502 007	ZS 280	0 221 604 103	ZSE 148	0 986 221 028	ZS 248
0 221 102 060	ZS 115	0 221 502 429	ZS 296	0 221 604 115	ZSE 142	0 986 221 029	ZS 249
0 221 102 061	ZS 109	0 221 502 431	ZS 339	0 222 001 001	ZS 210	0 986 221 030	ZS 254
0 221 102 066	ZS 109	0 221 502 433	ZS 298	0 222 001 002	ZS 210	0 986 221 031	ZS 255
0 221 102 067	ZS 106	0 221 502 435	ZS 299	0 222 002 002	ZS 215	0 986 221 032	ZS 277
0 221 102 068	ZS 106	0 221 502 460	ZS 357	0 222 002 004	ZS 215	0 986 221 033	ZS 315
0 221 102 069	ZS 115	0 221 503 001	ZS 300	0 222 003 001	ZS 220	0 986 221 034	ZS 381
0 221 102 071	ZS 109	0 221 503 002	ZS 301	0 222 003 003	ZS 220	0 986 221 035	ZSE 047
0 221 102 072	ZS 115	0 221 503 003	ZS 231	0 222 003 032	ZS 220	0 986 221 039	ZS 259
0 221 102 074	ZS 106	0 221 503 004	ZS 341	0 222 003 036	ZS 220	0 986 221 040	ZS 053
0 221 102 075	ZS 106	0 221 503 005	ZS 307	0 222 003 039	ZS 220	0 986 221 042	ZS 320
0 221 102 076	ZS 106	0 221 503 005-7G8	ZS 307	0 222 003 040	ZS 220	0 986 221 043	ZS 322
0 221 102 077	ZS 106	0 221 503 006	ZS 231	0 222 003 042	ZS 220	0 986 221 044	ZS 501
0 221 102 078	ZS 109	0 221 503 007	ZS 341	0 222 003 043	ZS 220	0 986 221 045	ZS 052
0 221 102 079	ZS 109	0 221 503 010	ZS 451	0 227 100 023	ZM 004	0 986 JG1 211	ZSE 021
0 221 102 081	ZS 110	0 221 503 011	ZS 450	0 227 100 024	ZM 004	0 986 JG1 212	ZSE 081
0 221 102 082	ZS 106	0 221 503 012	ZS 297	0 227 100 029	ZM 005	0 986 JG1 213	ZSE 080
0 221 118 002	ZS 400	0 221 503 014	ZS 358	0 227 100 042	ZM 004	0 986 JG1 214	ZSE 073
0 221 118 003	ZS 400	0 221 503 015	ZSE 147	0 227 100 043	ZM 004	0 986 JG1 215	ZSE 074
0 221 118 307	ZS 117	0 221 503 017	ZS 306	0 227 100 100	ZM 002	0 986 JG1 216	ZSE 071
0 221 118 329	ZS 118	0 221 503 022	ZS 304	0 227 100 101	ZM 002	0 986 JG1 222	ZSE 082
0 221 118 335	ZS 122	0 221 503 024	ZS 231	0 227 100 102	ZM 001	1 137 010 025	ZM 003
0 221 118 351	ZS 119	0 221 503 025	ZS 232	0 227 100 103	ZM 002	1 224 509 050	WZ 09-2
0 221 118 387	ZS 119	0 221 503 026	ZSE 152	0 227 100 104	ZM 002	1 227 010 001	ZM 002
0 221 118 398	ZS 119	0 221 503 027	ZSE 153	0 227 100 110	ZM 001	1 227 010 002	ZM 001
0 221 118 442	ZS 122	0 221 503 031	ZSE 150	0 227 100 111	ZM 001	1 227 010 003	ZM 001
0 221 119 001	ZS 106	0 221 503 033	ZSE 146	0 227 100 112	ZM 001	1 227 010 003	ZM 015
0 221 119 005	ZS 109	0 221 503 035	ZS 297	0 227 100 113	ZM 002	1 227 010 004	ZM 002
0 221 119 006	ZS 109	0 221 503 407	ZS 234	0 227 100 114	ZM 004	1 227 010 005	ZM 015
0 221 119 008	ZS 106	0 221 503 417	ZS 230	0 227 100 115	ZM 004	1 227 010 006	ZM 015
0 221 119 009	ZS 115	0 221 503 421	ZS 231	0 227 100 116	ZM 002	1 227 010 008	ZM 001
0 221 119 011	ZS 109	0 221 503 422	ZS 341	0 227 100 118	ZM 002	1 227 010 039	ZM 015
0 221 119 014	ZS 106	0 221 503 457	ZS 234	0 227 100 120	ZM 039	1 227 010 100	ZM 002
0 221 119 015	ZS 109	0 221 503 468	ZSE 151	0 227 100 121	ZM 004	1 227 020 015	ZS 120
0 221 119 016	ZS 115	0 221 503 469	ZSE 149	0 227 100 122	ZM 004	1 227 020 017	ZS 126
0 221 119 017	ZS 115	0 221 503 471	ZS 359	0 227 100 123	ZM 001	1 227 020 026	ZS 120
0 221 119 018	ZS 106	0 221 503 472	ZS 338	0 227 100 124	ZM 015	1 227 020 027	ZS 120
0 221 119 020	ZS 106	0 221 503 485	ZS 387	0 227 100 126	ZM 004	1 227 020 028	ZS 123
0 221 119 021	ZS 115	0 221 503 489	ZS 307	0 227 100 129	ZM 004	1 227 020 029	ZS 125
0 221 119 022	ZS 115	0 221 503 489-7G8	ZS 307	0 227 100 136	ZM 004	1 227 020 035	ZS 127
0 221 119 025	ZS 106	0 221 503 490	ZS 422	0 227 100 137	ZM 002	1 227 022 003	ZM 008
0 221 119 026	ZS 106	0 221 504 004	ZS 302	0 227 100 138	ZM 002	1 227 022 008	ZM 002
0 221 119 027	ZS 106	0 221 504 005	ZS 310	0 227 100 139	ZM 002	1 227 022 017	ZM 003
0 221 119 028	ZS 106	0 221 504 006	ZS 310	0 227 100 140	ZM 003	1 227 022 018	ZM 003
0 221 119 030	ZS 109	0 221 504 014	ZS 311	0 227 100 142	ZM 012	1 227 022 024	ZM 032
0 221 119 031	ZS 110	0 221 504 017	ZS 337	0 227 100 143	ZM 012	1 227 022 028	ZM 034
0 221 119 034	ZS 106	0 221 504 020	ZS 449	0 227 100 145	ZM 040	1 227 022 031	ZM 003
0 221 119 035	ZS 106	0 221 504 024	ZS 095	0 227 100 147	ZM 012	1 227 022 034	ZM 036
0 221 119 036	ZS 115	0 221 504 027	ZS 535	0 227 100 148	ZM 001	1 227 030 030	ZM 013
0 221 119 037	ZS 115	0 221 504 029	ZS 302	0 227 100 200	ZM 026	1 227 030 049	ZM 014
0 221 119 038	ZS 115	0 221 504 035	ZS 090	0 227 100 209	ZM 063	1 227 030 062	ZS 309
0 221 119 039	ZS 106	0 221 504 100	ZS 324	0 227 100 210	ZM 063	1 227 030 071	ZS 361
0 221 119 040	ZS 106	0 221 504 410	ZS 014	0 227 100 211	ZM 062	1 237 010 014	ZM 008
0 221 119 044	ZS 115	0 221 504 456	ZS 428	0 227 900 006	WZR 09 KF	1 237 010 028	ZM 003
0 221 119 048	ZS 106	0 221 504 460	ZS 321	0 227 901 012	WZ 04-2	1 237 010 029	ZM 003
0 221 119 053	ZS 109	0 221 504 464	ZS 324	0 227 901 013	WZ 04-2	1 237 010 031	ZM 003
0 221 119 355	ZS 115	0 221 504 465	ZSE 145	0 227 901 014	WZ 18-2	1 237 010 038	ZM 003
0 221 122 001	ZS 400	0 221 504 470	ZSE 143	0 227 901 019	WZ 04-2	2 204 210 013	ZA 500
0 221 122 003	ZS 400	0 221 504 471	ZSE 144	0 227 901 020	WZ 04-2	2 204 211 030	ZA 501

<b>BOSCH</b>	<b>BERU</b>
2 204 211 043	ZA 510
2 204 211 045	ZA 509
2 212 940 001	ZA 503
9 220 081 030	ZS 106
9 220 081 054	ZS 106
9 220 081 504	ZS 314
9 220 081 505	ZS 250
9 221 334 411	ZS 123
9 221 334 412	ZS 123
9 221 334 416	ZS 120
9 222 067 034	ZM 049
916X0227100	ZM 004
A 221 F10 029	ZS 126
F 000 ZS0 001	ZS 127
F 000 ZS0 103	ZS 283
F 000 ZS0 105	ZS 314
F 000 ZS0 111	ZS 253
F 000 ZS0 112	ZS 252
F 000 ZS0 113	ZS 257
F 000 ZS0 114	ZS 247
F 000 ZS0 115	ZS 251
F 000 ZS0 116	ZS 275
F 000 ZS0 117	ZS 356
F 000 ZS0 202	ZS 300
F 000 ZS0 205	ZS 300
F 000 ZS0 209	ZSE 003
F 000 ZS0 210	ZSE 003
F 000 ZS0 211	ZS 395
F 000 ZS0 212	ZS 281
F 000 ZS0 221	ZS 354
F 005 X03 210	ZS 376
TJ 12/1	ZS 220
TJ 3/1	ZS 210
TJ 6/1	ZS 215
ZS-K 1X1	ZS 250
ZS-K 1X1	ZS 257
ZS-K 1X1	ZS 314
ZS-K 1X2	ZS 283
ZS-K 2X2	ZS 239
ZS-K 2X2	ZS 300
ZS-K 2X2	ZSE 003
ZS-K-1X1PM	ZS 090
ZS-K-2X2	ZS 422

<b>BOUGICORD</b>	<b>BERU</b>
154301	ZS 381
154302	ZSE 047
15430200001	ZSE 047
154303	ZSE 048
155003	ZS 358
155006	ZS 361
155007	ZS 088
155008	ZS 365
155010	ZS 350
155011	ZS 281
155013	ZS 242
155014	ZS 243
155015	ZS 315
155016	ZS 354
155021	ZS 347
155030	ZS 346
155031	ZS 351
155032	ZSE 045
155039	ZS 427
155040	ZS 352
155041	ZS 353
155043	ZSE 046
155045	ZS 359
155052	ZSE 026
155054	ZSE 044
155055	ZS 349
155057	ZS 344
155071	ZS 356
155074	ZS 079
155099	ZSE 502
155100	ZS 014
155101	ZSE 031
155103	ZSE 062
155104	ZSE 059
155106	ZSE 063
155109	ZSE 065
155110	ZSE 051
155111	ZSE 061

<b>BOUGICORD</b>	<b>BERU</b>
155120	ZS 436
155132	ZS 429
155146	ZS 095
155149	ZS 532
155153	ZS 501
155167	ZS 434
155300	ZS 302
155600	ZS 017
155700	ZS 014
156100	ZSE 003
156200	ZS 052
156300	ZS 259
156500	ZS 256
156600	ZS 323
156800	ZSE 045
157200	ZSE 039
157300	ZS 320
157400	ZSE 030
157500	ZSE 043
157700	ZSE 032
157800	ZSE 031

<b>BREMI</b>	<b>BERU</b>
11720	ZS 354
11722	ZS 242
11723	ZS 243
11727	ZS 230
11730	ZS 239
11731	ZSE 003
11732	ZS 307
11800	ZS 105
11801	ZS 106
11802	ZS 109
11803	ZS 110
11805	ZS 400
11811	ZS 126
11814	ZS 117
11816	ZS 122
11821	ZS 115
11822	ZS 124
11825	ZS 119
11855T	ZS 014
11856T	ZS 014
11857T	ZS 014
11859T	ZS 437
11860T	ZS 302
11869	ZS 016
11871	ZS 017
11873	ZS 297
11875	ZS 281
11876	ZS 253
11877	ZS 251
11877	ZS 316
11878	ZS 247
11879	ZS 257
11880	ZS 249
11881	ZS 231
11882	ZS 232
11882	ZS 341
11883	ZS 234
11884	ZS 258
11885	ZS 279
11886	ZS 276
11887	ZS 263
11888	ZS 277
11889	ZS 274
11890	ZS 282
11891	ZS 252
11892	ZSE 002
11893	ZSE 001
11894T	ZS 435
11896	ZS 252
11897	ZS 248
11898	ZS 244
11899	ZS 283
11905	ZS 119
11905	ZS 120
11906	ZS 123
11910	ZS 125
11911	ZS 127
11913	ZS 238
11915	ZS 275
11917	ZS 250

<b>BREMI</b>	<b>BERU</b>
11918	ZS 350
11922	ZS 344
11923	ZS 234
11926	ZS 234
11929	ZS 029
11930	ZS 245
11930	ZS 254
11931	ZS 246
11931	ZS 255
11937	ZS 237
14001	ZM 002
14002	ZM 001
14003	ZM 003
14004	ZM 012
14005	ZM 039
14006	ZM 004
14007	ZM 013
14008	ZM 014
14009	ZM 032
14010	ZM 034
14011	ZM 015
14012	ZM 040
14017	ZM 029
14018	ZM 036
14022	ZM 026
14050	ZM 038
14052	ZM 063
14053	ZM 062
14100	ZM 005
14101	ZM 006
14102	ZM 007
14103	ZM 008
14104	ZM 016
14151	ZM 019
14153	ZM 020
14154	ZM 018
14155	ZM 047
14156	ZM 041
14200	ZM 054
14201	ZM 056
14203	ZM 046
14250	ZM 010
14290	ZM 060
14300	ZM 009
14301	ZM 061
14350	ZM 022
14352	ZM 050
14353	ZM 051
14354	ZM 025
14355	ZM 049
14400	ZM 017
14450	ZM 048
14500	ZM 059
14501	ZM 058
14502	ZM 057
14550	ZM 024
14651	ZM 031
14750	ZM 053
14800	ZM 045
20110	ZS 324
20111	ZS 052
20112	ZSE 031
20113	ZSE 043
20114	ZSE 032
20115	ZSE 062
20116	ZSE 059
20117	ZSE 030
20119	ZS 324
20120	ZSE 142
20121	ZSE 063
20122	ZSE 044
20124	ZSE 065
20125	ZSE 051
20126	ZSE 061
20129	ZSE 029
20130	ZSE 009
20131	ZSE 021
20132	ZSE 004
20133	ZSE 013
20134	ZS 340
20135	ZSE 502
20136	ZS 259
20137	ZS 261
20139	ZS 371

<b>BREMI</b>	<b>BERU</b>
20141	ZS 511
20142	ZS 315
20143	ZS 266
20144	ZS 314
20145	ZS 041
20146	ZS 280
20149	ZSE 073
20151	ZSE 072
20153	ZS 313
20155	ZS 350
20155	ZS 422
20156	ZS 381
20157	ZS 304
20158	ZS 278
20159	ZSE 008
20160	ZSE 026
20161	ZSE 047
20163	ZS 356
20168	ZSE 037
20169	ZS 300
20170	ZS 264
20171	ZS 376
20172	ZS 501
20173	ZSE 011
20174	ZS 309
20175	ZS 361
20176	ZS 387
20177	ZS 126
20178	ZS 125
20178	ZS 127
20179	ZS 306
20180	ZS 053
20181	ZS 301
20182	ZS 241
20183	ZSE 045
20184	ZSE 147
20185	ZS 077
20186	ZSE 019
20188	ZS 118
20188	ZS 296
20189	ZS 338
20190	ZS 308
20192	ZSE 071
20193	ZS 342
20194	ZS 502
20195	ZSE 146
20197	ZS 311
20199	ZS 299
20200	ZS 317
20304	ZS 267
20306	ZS 347
20307	ZS 340
20310	ZS 451
20311	ZS 450
20312	ZS 428
20314	ZS 449
20315	ZS 433
20316	ZS 346
20318	ZSE 056
20319	ZS 298
20320	ZS 348
20321	ZS 359
20322	ZSE 081
20324	ZSE 078
20325	ZSE 082
20326	ZS 269
20328	ZS 337
20331	ZSE 041
20334	ZS 352
20335	ZS 358
20336	ZS 310
20337	ZSE 080
20340	ZS 349
20341	ZS 405
20347	ZS 318
20348	ZS 319
20351	ZS 379
20352	ZS 343
20357	ZSE 086
20359	ZSE 087
20361	ZS 436
20364	ZS 429
20365	ZSE 153
20366	ZSE 007

BERMI	BERU
20368	ZSE 152
20369	ZS 434
20375	ZS 031
20380	ZS 320
20381	ZS 395
20394	ZSE 076
20438	ZSE 143
20442	ZSE 132
8539	ZM 049

BSG	BERU
BSG 30-835-002	ZS 387

BUICK	BERU
96 415 010	ZS 508

CHAMPION	BERU
AMC 800B	ZS 283
AMC 920A	ZS 029
BAE 403 AE/245	ZSE 030
BAE 403 B	ZS 320
BAE 403 C	ZS 322
BAE 403 D	ZS 321
BAE 403 H	ZS 068
BAE 403 H/245	ZS 068
BAE 408 AE	ZSE 030
BAE 409 A	ZS 052
BAE 504 L	ZS 250
BAE 506 D	ZS 244
BAE 506 F	ZS 248
BAE 507 AK	ZS 257
BAE 507 BK	ZS 249
BAE 700 AK	ZS 323
BAE 800 B	ZS 283
BAE 801 AK	ZS 317
BAE 801 BK	ZS 318
BAE 801 CK	ZS 319
BAE 801 EK	ZS 315
BAE 850	ZS 284
BAE 850 AK	ZS 284
BAE 851 AE	ZSE 001
BAE 907 AE	ZSE 003
BAE 920 AX	ZS 029
BAE 940 A	ZS 079
BAE 940 A/245	ZS 079
BAE 945 A/245	ZS 381
BAE 946 A	ZSE 047
BAE 947 A	ZS 375
BAE 960 AE	ZSE 039
BAE 961 AE	ZSE 040
BAE 965 A	ZS 259
BAE 965 A/245	ZS 259
C608850.52	ZS 284

CHERY	BERU
S11-3705100	ZS 518

CHEVROLET	BERU
96 415 010	ZS 508

CHRYSLER	BERU
00K 04609088 AG	ZS 432
00K 68081914 AA	ZS 096
00K 68081914 AB	ZS 096
04557468	ZS 379
04609080	ZS 379
04609088 AB	ZS 432
04609088 AC	ZS 432
04609088 AD	ZS 432
04609088 AE	ZS 432
04609088 AF	ZS 432
04671025	ZS 379
05269670	ZS 380
05269670AB	ZS 392
056032521	ZS 380
2495531	ZS 106
4443971	ZS 405
4557468	ZS 379

CHRYSLER	BERU
4609080	ZS 379
4671025	ZS 379
4762312	ZS 393
4797293	ZS 394
5252673	ZS 404
5269670	ZS 380
53006565	ZS 407
53006566	ZS 398
56028172AB	ZS 396
56032521	ZS 380
56032521AB	ZS 380
68081914 AA	ZS 096
68081914 AB	ZS 096
A 50633880	ZM 001
K 04609088 AF	ZS 432
K 04609088 AH	ZS 432
K 04609095 AD	ZS 431
K 04609095 AE	ZS 431
K 04609095 AF	ZS 431
K 04609095 AG	ZS 431
K 04609095 AH	ZS 431
K 04609095 AI	ZS 431
MD 112479	ZM 049
MD 164475	ZM 049
T 1031135	ZS 251
V 7203971AA	ZS 406

CITROËN	BERU
0000597055	ZS 346
0000597057	ZS 343
0000597073	ZS 349
0000597075	ZS 348
0000597077	ZS 347
0000597078	ZSE 047
0000597079	ZSE 047
0000597080	ZSE 045
0000597084	ZS 351
0000597087	ZS 352
0000597090	ZSE 048
0000597092	ZS 353
0000597094	ZS 347
0000597097	ZSE 048
5412342	ZS 110
5412977	ZS 110
5490504	ZS 115
5491302	ZS 115
5491559	ZS 115
592790	ZM 001
594502	ZM 001
594545	ZM 003
594555	ZM 003
594560	ZM 001
597053	ZS 234
597064	ZSE 143
7400269207	ZS 400
75455219	ZS 115
7910035100	ZM 001
91504912	ZM 001
9150491280	ZM 001
9150494480	ZM 001
9150633880	ZM 001
94531304	ZM 003
9453130480	ZM 003
96010513	ZS 247
96035284	ZS 249
96041378	ZS 258
96062288	ZS 231
9607361280	ZM 026
96074054	ZS 341
9611412080	ZS 323
96165970	ZS 341
9616597080	ZS 231
96211048	ZS 256
9621308680	ZS 241
96213181	ZS 346
96228897	ZS 232
96292106	ZS 349
9629210680	ZS 349
96341314	ZS 348
9634131480	ZS 348
96358649	ZSE 047
9654347080	ZSE 048
9752287580	ZM 001

CITROËN	BERU
97522876	ZM 001
97530125	ZM 001
9753012580	ZM 001
97530780	ZS 247
97531206	ZS 257
97531304	ZM 003
9753130480	ZM 003
97532831	ZM 001
97533831	ZM 001
DM 21208 B	ZS 106
MA 5455 219	ZS 115
N594503	ZM 001

CONTINENTAL AG	BERU
5WY2407A	ZS 518
5WY2809	ZS 513
5WY2809A	ZS 513
5WY2837A	ZS 516

DACIA	BERU
224332428R	ZSE 131
6001543604	ZS 354

DAELIM	BERU
30510-BA1-R300	ZS 519
30510-SA7-RZ00	ZS 520

DAEWOO	BERU
0001587503	ZS 340

DAF	BERU
285230	ZM 039
315447	ZS 106
345061	ZS 106
3501921	ZM 040
3501921-5	ZM 040
3501922	ZM 039

DELCoreMY	BERU
3474221	ZS 252
3474232	ZS 252
3474282	ZS 252

DELPHI	BERU
CE10000-12B1	ZS 259
CE10027-12B1	ZS 088
CE10512-12B1	ZS 501
CE20009-12B1	ZS 427
CE20010-12B1	ZS 381
CE20011-12B1	ZSE 047
CE20018-12B1	ZS 375
CE20024-12B1	ZS 349
CE20030-12B1	ZSE 030
CE20039-12B1	ZS 309
CE20042-12B1	ZS 365
CE20048-12B1	ZS 354
CE20058-12B1	ZS 283
DLB101	ZS 106
DLB102	ZS 109
DS10000-12B1	ZSE 026
GN10199-12B1	ZS 451
GN10204-12B1	ZSE 147
GN10221	ZS 532
GN10235-12B1	ZSE 140
GN10243	ZSE 134
GN10246	ZSE 132

DENSO	BERU
029700-8291	ZS 052
029700-848	ZS 502
131000-0011	ZM 059
131000-0511	ZM 058
131000-0920	ZM 058
131000-920	ZM 058
131300-0011	ZM 059
131300-0033	ZM 057

DENSO	BERU
131300-0072	ZM 057
131300-0120	ZM 059
131300-0121	ZM 059
131300-0330	ZM 057
GCL 209	ZS 501
GCL 219	ZS 502
MB 029700-8230	ZS 501
MB 029700-848	ZS 502

DUCATI	BERU
28540031 A	ZS 284
38010143 A	ZS 085
38010143 B	ZS 085
38010144 B	ZS 441
38010145 B	ZS 085
38010151 A	ZS 507
38040081 A	ZS 054
38040082 A	ZS 054
38040101 C	ZS 056
38040161 A	ZS 444
38040221 B	ZS 439

ECHLIN	BERU
93061	ZM 012
9458	ZM 015
9620	ZM 023
9691	ZM 024
9674	ZM 015
TP 31	ZM 019
TP 45	ZM 005
TP 49	ZM 016

EPS	BERU
1.970.199	ZS 356
1.970.220	ZS 511
1.970.261	ZS 274
1.970.272	ZS 344
1.970.352	ZS 437
1.970.365	ZS 345
1.970.377	ZS 354
1.970.379 S	ZS 350
1.970.380 S	ZS 365
1.970.397	ZS 361
1.970.425	ZSE 062
1.970.427	ZSE 032
1.970.429	ZSE 043
1.970.431	ZSE 059
1.970.433	ZSE 061
1.970.434	ZSE 044
1.970.435	ZSE 063
1.970.436	ZSE 051
1.970.437	ZSE 065

ERA	BERU
880006	ZSE 030
880007	ZSE 043
880009	ZS 052
880015	ZS 344
880035	ZSE 047
880039	ZS 259
880040	ZSE 026
880048	ZS 239
880049	ZS 350
880052	ZS 276
880053	ZS 275
880054	ZS 279
880055	ZS 263
880056	ZS 345
880058	ZS 354
880059	ZSE 011
880065	ZSE 032
880066	ZSE 031
880067	ZS 068
880072	ZS 356
880073	ZS 348
880076	ZSE 021
880078	ZS 358
880079	ZS 361
880084	ZS 346
880085	ZSE 045

ERA	BERU
880086	ZS 349
880087	ZS 351
880088	ZS 375
880091	ZS 079
880095	ZS 347
880098	ZS 337
880103	ZS 387
880109	ZS 234
880111	ZS 106
880117	ZSE 048
880118	ZS 352
880119	ZS 353
880121	ZSE 046
880122	ZSE 044
880124	ZSE 081
880125	ZS 359
880129	ZS 309
880131	ZS 234
880138	ZS 266
880139	ZS 264
880141	ZS 267
880142	ZS 261
880145	ZSE 502
880146	ZS 522
880150	ZS 521
880152	ZSE 136
880153	ZS 427
880161	ZSE 082
880163	ZSE 010
880166	ZSE 059
880168	ZSE 130
880180	ZS 340
880182	ZS 371
880183	ZS 282
880184	ZS 234
880186	ZS 433
880191	ZS 501
880193	ZS 365
880196	ZS 434
880204	ZSE 086
880205	ZSE 087
880207	ZS 277
880209	ZS 441
880213	ZSE 056
880214	ZS 436
880224	ZS 511
880225	ZS 274
880254	ZS 367
880271	ZS 532
880274	ZSE 066
880278	ZS 095
880294	ZS 410
880295	ZS 372
880296	ZS 281
880297	ZS 380
880301	ZSE 076
880302	ZSE 080
880318	ZSE 088
880339	ZSE 126
880345	ZSE 068
880345	ZSE 137
880348	ZSE 140
880373	ZS 395
DM1951	ZM 007

EUROCABLE	BERU
DC-1225	ZSE 140

FACET	BERU
1.965.035	ZM 040
1.965.051	ZM 027
1.970.102	ZS 248
1.970.105	ZS 247
1.970.106	ZS 257
1.970.107	ZS 251
1.970.108	ZS 244
1.970.110	ZS 252
1.970.111	ZS 252
1.970.124	ZS 119
1.970.124	ZS 120
1.970.125	ZS 124
1.970.126	ZS 123

FACET	BERU
1.970.135	ZS 281
1.970.140	ZS 253
1.970.141	ZS 120
1.970.146	ZS 283
1.970.155	ZS 249
1.970.156	ZS 258
1.970.158	ZS 248
1.970.159	ZSE 002
1.970.168	ZS 234
1.970.169	ZS 126
1.970.171	ZS 230
1.970.174	ZS 234
1.970.178	ZS 296
1.970.178	ZS 339
1.970.179	ZS 298
1.970.180	ZS 117
1.970.188	ZS 232
1.970.188	ZS 341
1.970.189	ZS 231
1.970.191	ZS 125
1.970.192	ZS 127
1.970.196	ZS 315
1.970.196	ZS 327
1.970.213	ZS 276
1.970.214	ZS 275
1.970.215	ZS 278
1.970.221	ZS 277
1.970.228	ZS 250
1.970.229	ZS 274
1.970.233	ZS 279
1.970.273	ZS 300
1.970.275	ZS 317
1.970.276	ZS 318
1.970.277	ZS 319
1.970.283	ZS 261
1.970.284	ZS 263
1.970.299	ZS 239
1.970.299 S	ZS 281
1.970.307	ZS 307
1.970.314	ZS 310
1.970.316	ZS 340
1.970.317	ZS 313
1.970.341	ZS 252
1.970.345	ZS 029
1.970.354	ZS 016
1.970.355	ZS 245
1.970.355	ZS 254
1.970.356	ZS 246
1.970.356	ZS 255
1.970.376	ZS 242
1.970.378	ZS 243
1.970.379 S	ZS 350
1.970.382	ZS 311
1.970.387	ZS 309
1.970.387	ZS 309
1.970.394	ZSE 011
1.970.412	ZS 014
1.970.414	ZS 304
1.970.417	ZS 297
1.970.450	ZS 427
1.990.420	ZSE 003
1.990.423	ZSE 037
465 035	ZM 040
465 051	ZM 027
470 102	ZS 248
470 105	ZS 247
470 106	ZS 257
470 107	ZS 251
470 108	ZS 244
470 110	ZS 252
470 111	ZS 252
470 124	ZS 119
470 124	ZS 120
470 125	ZS 124
470 126	ZS 123
470 135	ZS 281
470 140	ZS 253
470 141	ZS 120
470 146	ZS 283
470 155	ZS 249
470 156	ZS 258
470 158	ZS 248
470 159	ZSE 002
470 168	ZS 234
470 169	ZS 126

FACET	BERU
470 171	ZS 230
470 174	ZS 234
470 178	ZS 339
470 178	ZS 296
470 179	ZS 298
470 180	ZS 117
470 188	ZS 341
470 188	ZS 232
470 189	ZS 231
470 191	ZS 125
470 192	ZS 127
470 196	ZS 315
470 196	ZS 327
470 213	ZS 276
470 214	ZS 275
470 215	ZS 278
470 221	ZS 277
470 229	ZS 274
470 233	ZS 279
470 273	ZS 300
470 275	ZS 317
470 276	ZS 318
470 277	ZS 319
470 28	ZS 250
470 283	ZS 261
470 284	ZS 263
470 299	ZS 239
470 299 S	ZS 281
470 307	ZS 307
470 314	ZS 310
470 316	ZS 340
470 317	ZS 313
470 341	ZS 252
470 345	ZS 029
470 352	ZS 302
470 354	ZS 016
470 355	ZS 245
470 355	ZS 254
470 356	ZS 246
470 356	ZS 255
470 376	ZS 242
470 378	ZS 243
470 379 S	ZS 350
470 382	ZS 311
470 387	ZS 309
470 394	ZSE 011
470 412	ZS 014
470 414	ZS 304
470 417	ZS 297
470 450	ZS 427
490 420	ZSE 003
490 423	ZSE 037
9.4035	ZM 040
9.4051	ZM 027
9.6001	ZS 106
9.6002	ZS 248
9.6005	ZS 247
9.6006	ZS 257
9.6007	ZS 251
9.6008	ZS 244
9.6010	ZS 252
9.6011	ZS 252
9.6018	ZS 238
9.6024	ZS 119
9.6024	ZS 120
9.6025	ZS 124
9.6026	ZS 123
9.6035	ZS 281
9.6040	ZS 253
9.6041	ZS 120
9.6046	ZS 283
9.6055	ZS 249
9.6056	ZS 258
9.6058	ZS 248
9.6059	ZSE 002
9.6062	ZS 014
9.6068	ZS 234
9.6069	ZS 126
9.6071	ZS 230
9.6074	ZS 234
9.6075	ZS 115
9.6076	ZS 110
9.6078	ZS 296
9.6078	ZS 339

FACET	BERU
9.6079	ZS 298
9.6080	ZS 117
9.6088	ZS 232
9.6088	ZS 341
9.6089	ZS 231
9.6091	ZS 125
9.6092	ZS 127
9.6096	ZS 315
9.6096	ZS 327
9.6099	ZS 356
9.6113	ZS 276
9.6114	ZS 275
9.6115	ZS 278
9.6120	ZS 511
9.6121	ZS 277
9.6128	ZS 250
9.6129	ZS 274
9.6133	ZS 279
9.6161	ZS 274
9.6172	ZS 344
9.6173	ZS 300
9.6175	ZS 317
9.6176	ZS 318
9.6177	ZS 319
9.6183	ZS 261
9.6184	ZS 263
9.6199	ZS 239
9.6199 S	ZS 281
9.6207	ZS 307
9.6213	ZS 428
9.6214	ZS 310
9.6216	ZS 340
9.6217	ZS 313
9.6241	ZS 252
9.6245	ZS 029
9.6247	ZS 532
9.6254	ZS 016
9.6255	ZS 245
9.6255	ZS 254
9.6256	ZS 246
9.6256	ZS 255
9.6264	ZS 237
9.6265	ZS 345
9.6276	ZS 242
9.6277	ZS 354
9.6278	ZS 243
9.6279 S	ZS 350
9.6280 S	ZS 365
9.6282	ZS 311
9.6287	ZS 309
9.6289	ZS 450
9.6294	ZSE 011
9.6297	ZS 361
9.6300	ZSE 147
9.6305	ZSE 047
9.6312	ZS 014
9.6313	ZS 435
9.6314	ZS 304
9.6317	ZS 297
9.6325	ZSE 062
9.6326	ZSE 142
9.6327	ZSE 032
9.6329	ZSE 043
9.6331	ZSE 059
9.6333	ZSE 061
9.6334	ZSE 044
9.6336	ZSE 051
9.6337	ZSE 065
9.6350	ZS 427
9.6374	ZSE 030
9.6375	ZSE 143
9.6381	ZS 387
9.6407	ZSE 151
9.6432	ZS 422
9.6479	ZS 536
9.8120	ZSE 003
9.8123	ZSE 037
EPS 1.970.377	ZS 354
EPS 1.970.532	ZS 422
KW 470 377	ZS 354
KW 470 532	ZS 422



FAE	BERU
80209	ZS 259
80210	ZSE 026
80216	ZS 437
80229	ZS 361
80241	ZS 356
80250	ZS 532
80254	ZS 501

FARCOM	BERU
103011	ZSE 152
103013	ZSE 150

FAUN	BERU
4796501	ZS 105

FEBI BILSTEIN	BERU
17194	ZSE 001
19032	ZSE 003
19929	ZS 283
21109	ZS 014
21524	ZS 354
21525	ZS 345
21526	ZS 243
21527	ZS 242
21528	ZS 251
21528	ZS 316
21529	ZS 315
21569	ZS 350
21666	ZS 052
22038	ZSE 030
22389	ZS 259
22581	ZS 231
22697	ZS 029
22875	ZS 317
23187	ZS 342
23258	ZSE 142
23260	ZSE 032
24106	ZSE 043
24108	ZSE 009
24435	ZS 347
24500	ZSE 059
24996	ZS 381
24997	ZSE 047
26496	ZS 375
26869	ZS 350
27132	ZSE 003
27168	ZS 358
27470	ZSE 043
27522	ZS 359
28108	ZS 427
28487	ZSE 033
28533	ZS 339
28538	ZS 340
28548	ZSE 146
28645	ZS 356
29147	ZS 302
29319	ZSE 029
29412	ZS 016
29859	ZSE 051
30261	ZSE 502
33666	ZSE 147
36080	ZSE 144
36100	ZSE 143
36113	ZSE 145
36358	ZSE 033
36999	ZS 422

FERRARI	BERU
134386	ZS 234
183276	WZ 09-2
248404	ZSE 128
248406	ZSE 127
94531230	WZ 09-2

FIAT	BERU
0009633001580	ZS 347
0009663278480	ZS 347
4071394	ZS 106
4324184	ZS 106

FIAT	BERU
4384184	ZS 106
4419628	ZM 005
46403328	ZS 310
46446039	ZS 029
46467542	ZS 311
46469863	ZS 309
46472440	ZS 029
46480361	ZS 029
46543562	ZS 283
46548037	ZS 283
46755605	ZS 361
46776830	ZS 321
46777286	ZS 320
46777287	ZS 321
46777288	ZS 322
46790073	ZS 283
55180004	ZS 320
55200112	ZS 079
55200486	ZS 079
55208723	ZS 079
55209603	ZS 095
55213613	ZS 095
55224494	ZS 095
55231256	ZS 090
55234131	ZS 090
60504288	ZM 001
60558152	ZS 234
60572202	ZS 122
60590028	ZM 001
60590029	ZM 001
60623365	ZS 122
60755012	ZM 003
60755094	ZM 003
60808059	ZS 230
60809606	ZS 234
60810690	ZS 428
68081914 AA	ZS 096
68081914 AB	ZS 096
71716152	ZS 119
71739725	ZS 427
7553120	ZS 248
7582152	ZS 244
7588435	ZS 248
7612954	ZS 119
7612954	ZS 120
7612955	ZM 040
7626232	ZS 283
7646974	ZS 248
7648797	ZS 234
7663177	ZS 244
7672018	ZS 283
7698431	ZS 244
7746152	ZS 244
7746153	ZS 248
7746154	ZS 244
7789346	ZS 029
82281565	WZ 09-2
82303852	ZS 106
82369531	ZM 005
9607405480	ZS 341
9622889780	ZS 232
9604137880	ZS 258
9612955	ZM 040
975301258	ZM 001
9940095	ZM 009
9942040	ZM 017

FISPA	BERU
85.30020	ZS 521
85.30072	ZSE 051
85.30110	ZSE 063
85.30111	ZSE 047
85.30166	ZSE 026
85.30196	ZSE 061
85.30197	ZSE 062
85.30218	ZS 532
85.30250	ZS 095
85.30267	ZSE 136
85.30347	ZS 395
85.30366	ZSE 067
85.30366	ZSE 126
85.30368	ZSE 137
85.30368	ZSE 068

FISPA	BERU
85.30373	ZSE 140
85.30395	ZS 439
85.30396	ZS 440
85.30400	ZS 441
85.30403	ZSE 130

FORD	BERU
1008464	ZSE 004
1008886	ZS 237
1008887	ZS 237
1018139	ZS 237
1018140	ZS 237
1027286	ZS 126
1052492	ZS 350
1053904	ZS 350
1066102	ZS 350
1067601	ZS 350
1075786	ZS 350
1111213	ZS 422
1119835	ZS 365
1130402	ZS 350
1224925	ZS 408
1314271	ZS 408
1317972	ZS 350
1319788	ZS 365
1319929	ZS 422
1322402	ZS 408
1350562	ZS 387
1371601	ZSE 055
1459278	ZS 387
1505155	ZS 106
1517813	ZS 422
1535713	ZS 079
1578771	ZS 408
1619343	ZS 422
1629456	ZM 019
1671690	ZS 079
1727629	ZS 387
1754514	ZS 387
1953302	ZS 277
1953306	ZS 277
157G-12029-AB	ZS 365
157G-12029-AC	ZS 365
2W4E-12A366-AC	ZS 367
2W4E-12A366-AD	ZS 367
2W4E-12A366-BB	ZS 368
2W4E-12A366-BC	ZS 368
2W4E-12A366-BD	ZS 368
2W4E-12A366-BE	ZS 368
2W4Z-12029-A	ZS 367
2W4Z-12029-B	ZS 368
2W4Z-12029-BC	ZS 368
2W4Z-12029-BD	ZS 368
3W7E-12A366-AA	ZS 409
4424413	ZS 368
448298	ZS 115
4586554	ZS 368
4667153	ZS 368
4751265	ZS 372
4L7E-12A366-AA	ZS 369
4L7E-12A366-AB	ZS 369
4L7Z-12029-AB	ZS 369
4M5E12A366AA	ZS 408
4M5G-12029-ZA	ZS 387
4M5G-12029-ZB	ZS 387
4M5G12A366BA	ZS 408
4M5G12A366BB	ZS 408
4M5G-12A366-BC	ZS 408
4M5G12A366-BD	ZS 408
4M5U-12A366-BC	ZS 408
5006104	ZS 106
5008049	ZS 367
5008050	ZS 368
5008190	ZS 372
5008196	ZS 371
5047437	ZS 408
5F2E12029AA	ZS 372
5F2E12029AB	ZS 372
6077429	ZS 126
6086506	ZM 008
6135656	ZM 008
6153380	ZM 020
6153451	ZM 003

FORD	BERU
6159437	ZM 003
6181956	ZS 238
6485688	ZS 308
6489415	ZS 371
6503277	ZS 238
6503278	ZS 238
6630365	ZS 371
6860288	ZS 239
6860288	ZS 281
6958305	ZS 371
6M5G12029AA	ZSE 055
71HM12024 BA	ZS 109
71OM12KO18E2A	ZS 106
7390767	ZS 360
79BB12024AA	ZS 126
7U2J12029AB	ZS 281
81SF12K059AB	ZM 008
81SF12K059AA	ZM 008
84SF12K057AA	ZM 020
84SF12K059AA	ZM 020
84SF12K067BA	ZM 003
86BF12K062A	ZM 003
86BF12K062AA	ZM 003
88SF12029A2A	ZS 281
88SF12029A2B	ZS 281
88SF12029AA	ZS 238
919F12029AA	ZS 371
91XF12029AA	ZS 308
91XF12029BA	ZS 308
928F12029CA	ZS 239
928F12029CA	ZS 281
92GB12024AA	ZS 126
938F12024DA	ZS 239
95VW12029AA	ZSE 004
96FB12257AB	ZS 237
988F12029AA	ZS 350
988F12029AB	ZS 350
988F12029AC	ZS 350
988F12029AD	ZS 350
988F12029BA	ZS 422
98BF12024AB	ZS 350
98VW12A223AA	ZM 062
9L8E12A366AA	ZS 410
9S5112029AA	ZS 079
9S5112029AB	ZS 079
A71012KO18E2A	ZS 106
A790X12KO18CA	ZS 106
AM5E12A366AA	ZS 408
AM5E12A366AB	ZS 408
B3124Q03A	ZM 022
CM5G12029FA	ZS 387
CM5G12029FB	ZS 387
E2FS12A297B	ZM 043
E3EF12A297A1A	ZM 019
E3EF12A297A2A	ZM 019
E43Z12A297A	ZM 019
E43ZP12Z297A	ZM 019
E5RF12A297BA	ZM 019
E6EF12A297AA	ZM 019
E8FZ12A297A	ZM 019
E8GY12029B	ZS 274
E92Z12029B	ZS 274
E92Z12A297A	ZM 024
E9SF12029AA	ZS 371
E9SZ12029A	ZS 371
E9TF12029AA	ZS 281
E9ZZ12A297A	ZM 024
ESFZ12Z297	ZM 043
F02Z12A297A	ZM 024
F02Z12A297B	ZM 048
F1CZ12029A	ZS 279
F1SU12029AA	ZS 371
F3XA12029AA	ZS 277
F3XY12029A	ZS 277
F3XY12A297A	ZM 048
F3XY12D072A	ZM 048
F3XY12K072A	ZM 048
F57U12029AA	ZS 370
F57U12029AB	ZS 370
F5SU12029AA	ZS 371
F5SU12029AB	ZS 371
F5XZ12029AA	ZS 277
F6DU12A366AB	ZS 366

FORD	BERU
F6DU12A366AC	ZS 366
FOBZ12A297A	ZM 050
V93HF12029AA	ZS 360
YM2F12029AD	ZS 350
YM2F12024AB	ZS 422
YM2F12024AC	ZS 422
YM2F12029AB	ZS 422

FRIESEN	BERU
XIC8259	ZS 088

GEO	BERU
96056317	ZM 049
96065317	ZM 049
96067829	ZM 049

GM	BERU
03474232	ZS 252
03474282	ZS 252
10458316	ZS 427
10467067	ZS 355
10468391	ZS 355
10472401	ZS 355
10482825	ZM 007
120875	ZS 306
1208047	ZS 125
12596547	ZSE 133
12612369	ZSE 133
19005212	ZS 259
1976908	ZM 043
1977907	ZM 043
1977958	ZM 016
1978617	ZM 043
1979107	ZM 016
1979571	ZM 016
1985703	ZM 007
1987744	ZM 043
25518356	ZS 416
3474233	ZS 253
3474233	ZS 253
90006145	ZM 002
90008145	ZM 002
90056698	ZM 002
90062964	ZM 002
90114676	ZM 002
90140187	ZM 002
90187341	ZM 002
90241775	ZM 034
90243618	ZM 018
90243618	ZM 041
90243630	ZM 041
90273966	ZM 032
90274682	ZM 032
90279786	ZM 034
90295498	ZM 001
90295499	ZM 001
90296502	ZM 034
90297486	ZM 034
90297786	ZM 034
90320586	ZM 034
90348296	ZS 125
90350021	ZS 127
90350987	ZM 034
90350987	ZS 127
90358386	ZS 301
90360314	ZM 018
90360314	ZM 041
90360315	ZM 018
90360315	ZM 041
90369434	ZS 127
90414405	ZM 001
90443900	ZS 300
90444148	ZS 301
90444184	ZS 301
90449572	ZS 300
90449739	ZS 253
90449740	ZS 252
90458250	ZS 344
90510386	ZS 253
90510387	ZS 252
90532618	ZS 358

GM	BERU
90536194	ZS 342
90541062	ZS 306
90543059	ZS 358
90563160	ZS 306
9119567	ZS 342
93177212	ZS 338
93180806	ZS 359
9404544	ZM 057
94243344	ZM 046
94404545	ZS 356
94840126	ZM 058
94853695	ZS 356

HANOMAG	BERU
000 158 320 3	ZS 106
540 146 030	ZS 106
547 935 731	ZS 106
547 935 733	ZS 106

HELLA	BERU
5DA 006 623-001	ZM 001
5DA 006 623-011	ZM 002
5DA 006 623-021	ZM 039
5DA 006 623-031	ZM 012
5DA 006 623-041	ZM 003
5DA 006 623-051	ZM 005
5DA 006 623-061	ZM 006
5DA 006 623-071	ZM 007
5DA 006 623-081	ZM 008
5DA 006 623-141	ZM 054
5DA 006 623-151	ZM 022
5DA 006 623-161	ZM 009
5DA 006 623-181	ZM 004
5DA 006 623-191	ZM 015
5DA 006 623-201	ZM 040
5DA 006 623-241	ZM 020
5DA 006 623-251	ZM 018
5DA 006 623-271	ZM 038
5DA 006 623-281	ZM 017
5DA 006 623-291	ZM 048
5DA 006 623-311	ZM 019
5DA 006 623-321	ZM 047
5DA 006 623-351	ZM 059
5DA 006 623-361	ZM 058
5DA 006 623-371	ZM 057
5DA 006 623-381	ZM 046
5DA 006 623-391	ZM 056
5DA 006 623-401	ZM 023
5DA 006 623-411	ZM 053
5DA 006 623-421	ZM 024
5DA 006 623-431	ZM 061
5DA 006 623-461	ZM 060
5DA 006 623-471	ZM 045
5DA 006 623-481	ZM 025
5DA 006 623-491	ZM 051
5DA 006 623-501	ZM 050
5DA 006 623-511	ZM 049
5DA 006 623-531	ZM 013
5DA 006 623-541	ZM 014
5DA 006 623-551	ZM 032
5DA 006 623-561	ZM 034
5DA 006 623-571	ZM 043
5DA 006 623-581	ZM 016
5DA 006 623-591	ZM 063
5DA 006 623-601	ZM 026
5DA 006 623-621	ZSE 001
5DA 006 623-631	ZM 052
5DA 006 623-641	ZM 055
5DA 006 623-691	ZM 029
5DA 006 623-701	ZSE 002
5DA 006 623-711	ZSE 001
5DA 006 623-771	ZM 062
5DA 749 245-291	ZS 297
5DA 749 475-001	ZS 283
5DA 749 475-011	ZS 231
5DA 749 475-021	ZS 232
5DA 749 475-031	ZS 354
5DA 749 475-041	ZS 234
5DA 749 475-051	ZS 307
5DA 749 475-061	ZS 340
5DA 749 475-071	ZS 313
5DA 749 475-091	ZS 029

HELLA	BERU
5DA 749 475-101	ZS 245
5DA 749 475-101	ZS 254
5DA 749 475-111	ZS 242
5DA 749 475-121	ZS 016
5DA 749 475-131	ZS 361
5DA 749 475-141	ZSE 021
5DA 749 475-151	ZS 281
5DA 749 475-161	ZS 052
5DA 749 475-171	ZSE 003
5DA 749 475-191	ZSE 026
5DA 749 475-201	ZS 255
5DA 749 475-211	ZS 243
5DA 749 475-221	ZS 014
5DA 749 475-231	ZS 259
5DA 749 475-281	ZS 304
5DA 749 475-311	ZS 302
5DA 749 475-321	ZS 315
5DA 749 475-331	ZS 317
5DA 749 475-341	ZS 309
5DA 749 475-381	ZS 371
5DA 749 475-401	ZS 308
5DA 749 475-411	ZS 387
5DA 749 475-441	ZS 342
5DA 749 475-451	ZS 358
5DA 749 475-461	ZSE 045
5DA 749 475-561	ZS 501
5DA 749 475-571	ZS 502
5DA 749 475-581	ZS 451
5DA 749 475-601	ZS 352
5DA 749 475-611	ZS 351
5DA 749 475-621	ZS 256
5DA 749 475-631	ZS 338
5DA 749 475-641	ZSE 047
5DA 749 475-651	ZS 241
5DA 749 475-671	ZS 428
5DA 749 475-691	ZSE 059
5DA 749 475-701	ZSE 061
5DA 749 475-771	ZS 016
5DA 749 475-781	ZS 052
5DA 749 475-791	ZS 053
5DA 749 475-801	ZS 077
5DA 749 475-811	ZS 259
5DA 749 475-821	ZSE 003
5DA 749 475-831	ZSE 009
5DA 749 475-851	ZSE 143
5DA 749 475-861	ZSE 030
5DA 749 475-871	ZSE 043
5DA 749 475-941	ZSE 081
5DA 749 475-951	ZSE 080
5DA 749 475-971	ZSE 132

HERTH&BUSS	BERU
19010006	ZM 001
19010007	ZM 003
19010008	ZM 005
19010011	ZM 043
19010028	ZM 019
19010029	ZM 039
19010034	ZM 013
19010035	ZM 032
19010036	ZM 031
19010037	ZM 034
19010040	ZM 036
19010044	ZM 015
19010047	ZM 040
19010052	ZM 048
19010053	ZM 061
19010054	ZM 048
19010056	ZM 017
19010060	ZM 049
19010062	ZM 046
19010064	ZM 050
19010065	ZM 051
19010069	ZM 052
19010072	ZM 053
19010077	ZM 056
19010078	ZM 057
19010080	ZM 059
19020001	ZSE 001
19020002	ZSE 002
19020004	ZS 106
19020005	ZSE 002
19020007	ZSE 003

HERTH&BUSS	BERU
19020008	ZS 283
19020009	ZS 422
19020010	ZSE 001
19020012	ZS 281
19020022	ZS 344
19020030	ZS 354
19020035	ZS 387
19020059	ZS 422
19050001	ZSE 043
19050002	ZSE 047
19050003	ZSE 047
19050004	ZSE 030
19050005	ZS 014
19050007	ZS 302
19050008	ZS 309
19050010	ZS 052
19050016	ZS 310
19050017	ZS 361
19050018	ZS 311
19050019	ZS 052
19050020	ZSE 032
19050022	ZS 307
19050025	ZS 259
19050026	ZS 313
19050028	ZSE 147
19050029	ZS 358
19050031	ZSE 146
19050032	ZSE 151
19050033	ZSE 055
19050034	ZS 346
19050036	ZS 347
19050037	ZSE 045
19050038	ZSE 046
19050039	ZS 348
19050040	ZS 351
19050041	ZS 352
19050042	ZS 353
19050043	ZSE 048
19050046	ZSE 142
19050048	ZSE 051
19050049	ZS 427

HITACHI	BERU
CM11201D	ZSE 009
CM11205	ZSE 021
CM1T204B	ZM 031
CM1T204D	ZM 031
CM1T204E	ZM 031
CM1T204F	ZSE 006
DIS405	ZM 027
DIS408	ZM 028
E12302	ZM 045
E12303	ZM 045
E1261	ZM 046
E1288	ZM 046

HOFFER	BERU
8010013	ZM 007
8010310	ZS 361
8010315	ZS 259
8010320	ZS 361
8010324	ZSE 047
8010326	ZS 358
8010328	ZSE 043
8010329	ZSE 030
8010336	ZS 354
8010350	ZS 532
8010370	ZS 371
8010372	ZSE 031
8010373	ZSE 032
8010378	ZS 309
8010384	ZS 344
8010387	ZS 356
8010389	ZS 088
8010395	ZS 079
8010401	ZSE 502
8010405	ZSE 045
8010409	ZS 380
8010410	ZS 511
8010416	ZS 346
8010417	ZS 349
8010418	ZS 347

HOFFER	BERU
8010419	ZS 351
8010420	ZS 376
8010420	ZS 375
8010421	ZSE 048
8010424	ZS 376
8010433	ZS 274
8010458	ZS 521
8010460	ZSE 059
8010462	ZS 387
8010470	ZSE 046
8010472	ZS 352
8010473	ZS 353
8010478	ZSE 030
8010480	ZS 427
8010483	ZS 359
8010497	ZSE 051
8010498	ZSE 063
8010500	ZSE 056
8010501	ZSE 031
8010503	ZSE 065
8010504	ZSE 061
8010505	ZSE 062
8010512	ZSE 136
8010541	ZS 095
8010573	ZS 395
8010576	ZS 436
8010578	ZSE 066
8010599	ZSE 067
8010599	ZSE 126
8010600	ZSE 140
8010602	ZSE 137
8010701	ZS 439
8010702	ZS 440
8010706	ZS 441
8010709	ZSE 130
8810391	ZS 348

HOLDEN	BERU
90444184	ZS 301
90541062	ZS 306

HONDA	BERU
06302-PT2-000	ZM 023
06302-PT2-A00	ZM 023
30120-PA-6921	ZM 056
30120-PA-921	ZM 059
30120-PAO-661	ZM 046
30120-PB-1006	ZM 056
30120-PH0-661	ZM 046
30120-PH4-005	ZM 046
30120-PH-7006	ZM 056
30120-PJ-7003	ZM 056
30120-PM5-A01	ZM 023
30120-PMA-01	ZM 023
30120-PR3-003	ZM 023
30130-P06-006	ZM 045
30500-634-015	ZS 106
30500-P0A-A01	ZS 532
30500-PCA-003	ZS 532
30500-PDA-E01	ZS 532
30500-PM5-A02	ZS 276
30500-PM5-A03	ZS 276
30500-PR4-A02	ZS 278
30510-P73-A01	ZS 275
30510-P73-A02	ZS 275
30510-PT2-006	ZS 275
30510-PV1-A01	ZS 418
30520 PDFE 00	ZS 234
30520-PH6-900	ZS 417
30520-PH6-902	ZS 417
30520-PT-3-A02	ZS 419
30550 PH 3004	ZM 055
30550-689-003	ZM 054
30550-692-004	ZM 054
30550-692-014	ZM 054
30550-692-2014	ZM 054

HÜCO	BERU
024-138811	ZS 422
13 3800	ZS 052
13 3801	ZS 322

HÜCO	BERU
13 3802	ZS 068
13 3803	ZS 347
13 3804	ZS 437
13 3805	ZS 016
13 3806	ZSE 043
13 3807	ZSE 030
13 3808	ZSE 033
13 3809	ZS 259
13 3810	ZS 342
13 3811	ZS 014
13 3812	ZSE 059
13 3814	ZS 340
13 3815	ZS 358
13 3816	ZSE 147
13 3817	ZS 381
13 3836	ZSE 142
13 3825	ZS 324
13 3827	ZS 320
13 3830	ZSE 031
13 3832	ZS 427
13 3834	ZSE 051
13 3837	ZS 501
13 3841	ZS 361
13 3847	ZSE 044
13 3850	ZS 429
13 3852	ZS 408
13 3855	ZSE 152
13 3856	ZSE 153
13 3860	ZSE 081
13 3875	ZSE 143
13 3876	ZSE 144
13 3879	ZSE 151
13 3880	ZSE 150
13 3901	ZSE 088
13 3906	ZSE 132
13 3907	ZSE 080
13 3921	ZSE 082
13 3922	ZSE 077
13 3923	ZSE 076
13 8021	ZM 005
13 8042	ZM 019
13 8043	ZM 020
13 8052	ZM 063
13 8055	ZM 062
13 8406	ZM 029
13 8416	ZSE 002
13 8419	ZSE 001
13 8425	ZSE 003
13 8430	ZSE 026
13 8434	ZSE 004
13 8437	ZSE 013
13 8438	ZSE 029
13 8451	ZM 025
13 8701	ZSE 002
13 8702	ZSE 001
13 8704	ZSE 003
13 8705	ZS 280
13 8707	ZS 314
13 8708	ZSE 004
13 8709	ZS 297
13 8710	ZS 304
13 8717	ZS 395
13 8730	ZS 283
13 8736	ZS 317
13 8738	ZS 315
13 8750	ZS 316
13 8751	ZS 251
13 8752	ZS 249
13 8754	ZS 247
13 8756	ZS 231
13 8757	ZS 254
13 8758	ZS 255
13 8759	ZS 242
13 8760	ZS 232
13 8761	ZS 451
13 8766	ZS 243
13 8780	ZS 253
13 8781	ZS 252
13 8800	ZS 238
13 8801	ZS 370
13 8802	ZS 371
13 8803	ZS 350
13 8808	ZS 387
13 8810	ZS 532

HÜCO	BERU
13 8811	ZS 422
13 8812	ZS 275
13 8813	ZS 278
13 8814	ZS 276
13 8817	ZS 372
13 8842	ZS 263
13 8850	ZS 282
13 8865	ZS 356

HYUNDAI	BERU
0K 013-18-100	ZS 434
0K 247-18100	ZS 433
0K 2A 318 100A	ZS 436
27120-21020	ZM 053
27120-21050	ZM 053
27300-39000	ZSE 086
27300-39050	ZSE 086
27300-39700	ZSE 087
27301-02502	ZSE 011
27301-02600	ZS 266
27301-03000	ZS 536
27301-03010	ZS 536
27301-03030	ZS 536
27301-22040	ZS 264
27301-22050	ZS 264
27301-23003	ZS 267
27301-24510	ZS 263
27301-24520	ZS 263
27301-32800	ZS 261
27301-32810	ZS 261
27301-32820	ZS 261
27301-32840	ZS 526
27301-32850	ZS 526
27301-33510	ZS 521
27301-33520	ZS 521
27301-37100	ZS 269
27301-37105	ZS 522
27301-38020	ZSE 502
27360-32800	ZM 049
96056317	ZM 049
96067829	ZM 049

IKCO	BERU
5WY2829A	ZS 515

INTERMOTOR	BERU
11000	ZS 106
11030	ZS 106
11060	ZS 109
11070	ZS 109
11150	ZS 115
11200	ZS 106
11220	ZS 115
11330	ZS 126
11410	ZS 121
11480	ZS 124
11500	ZS 125
11500	ZS 127
11510	ZS 119
11510	ZS 120
11510	ZS 123
11800	ZS 400
12200	ZS 252
12202	ZS 252
12203	ZS 253
12271	ZS 367
12301	ZS 251
12302	ZS 247
12303	ZS 257
12305	ZS 258
12428	ZS 372
12589	ZS 242
12596	ZS 354
12598	ZS 300
12601	ZS 244
12602	ZS 248
12605	ZS 248
12606	ZS 016
12607	ZS 243
12608	ZS 014
12609	ZS 302

INTERMOTOR	BERU
12610	ZS 277
12611	ZS 274
12613	ZS 232
12613	ZS 341
12614	ZS 281
12615	ZS 282
12616	ZS 231
12617	ZS 263
12618	ZS 276
12619	ZS 283
12621	ZSE 002
12622	ZS 014
12623	ZS 234
12624	ZS 279
12626	ZS 252
12635	ZS 371
12636	ZS 230
12637	ZS 234
12639	ZS 339
12640	ZS 298
12646	ZS 315
12649	ZS 356
12659	ZS 275
12660	ZS 278
12662	ZS 250
12678	ZS 344
12679	ZS 317
12680	ZS 318
12681	ZS 319
12683	ZS 261
12699	ZS 239
12700	ZS 029
12701	ZS 254
12702	ZS 255
12703	ZS 281
12705	ZS 345
12709	ZSE 011
12710	ZS 307
12714	ZS 350
12715	ZS 365
12717	ZS 309
12720	ZSE 047
12722	ZS 358
12723	ZS 259
12724	ZS 342
12726	ZSE 029
12731	ZS 256
12736	ZS 340
12739	ZS 501
12745	ZS 361
12747	ZS 348
12749	ZSE 045
12750	ZS 349
12755	ZS 346
12756	ZS 351
12764	ZS 345
12766	ZS 347
12767	ZSE 046
12772	ZS 387
12773	ZS 068
12778	ZSE 059
12790	ZSE 044
12791	ZSE 065
12812	ZSE 502
12818	ZSE 055
12832	ZSE 056
12859	ZSE 055
12916	ZSE 001
12919	ZSE 003
15881	ZM 060

ISKRA	BERU
AEV 14 0112	ZM 001
AEV 1401	ZM 001

ISUZU	BERU
8-01103-830-0	ZS 355
8-10468-391-0	ZS 355
8-10472-401-0	ZS 355
8-12596-547-0	ZSE 133
8-94243-344-0	ZM 046
8-94404-544-0	ZM 057

ISUZU	BERU
8-94404-545-0	ZS 356
8-97315-438-0	ZSE 135
9-81360-005	ZS 106
9-82511-535	ZS 106
9-82513-509	ZS 106

IVECO	BERU
4419628	ZM 005
7612955	ZM 040
975301258	ZM 001

JAGUAR	BERU
C2S42751	ZS 367
FOR6077429	ZS 126
XR827823	ZS 368
XR842741	ZS 367

JANMOR	BERU
JM5002	ZS 437
JM5009	ZS 068
JM5011	ZSE 030
JM5022	ZS 361
JM5028	ZS 354
JM5070	ZS 380
JM5071	ZS 379
JM5072	ZS 405
JM5084	ZSE 059
JM5085	ZS 501
JM5093	ZS 387
JM5103	ZS 436
JM5108	ZS 521
JM5111	ZSE 502
JM5253	ZSE 061
JM5254	ZSE 062
JM5268	ZSE 065
JM5353	ZSE 130
JM5354	ZS 441
JM5372	ZSE 088
JM5431	ZSE 140
ODM251	ZS 259
ODM253	ZS 358
ODM258	ZS 427

JP GROUP	BERU
881208307	ZS 259
905062001	ZSE 003
905066001	ZSE 030

KAGER	BERU
00-0911	ZSE 040
00-0912	ZSE 003
00-0914	ZSE 030
00-0915	ZSE 043
00-0916	ZSE 029
60-0002	ZS 356
60-0017	ZS 346
60-0020	ZSE 043
60-0035	ZSE 045
60-0036	ZS 088
60-0042	ZS 354
60-0057	ZS 361
60-0061	ZSE 030
60-0067	ZS 349
60-0068	ZSE 047
60-0070	ZS 348
60-0076	ZSE 032
60-0078	ZS 351
60-0079	ZS 345
60-0080	ZS 259
60-0086	ZS 358
60-0094	ZSE 048
60-0095	ZS 352
60-0096	ZS 353
60-0098	ZSE 046
60-0108	ZS 359
60-0109	ZS 079
60-0113	ZS 347
60-0114	ZS 427
60-0121	ZSE 066

KHD	BERU
117 7427	ZS 120
415 4913	ZM 039

KIA	BERU
OK 011-18-100	ZS 234
OK 013-18-100	ZS 434
OK 247-18100	ZS 433
OK 247-18100 A	ZS 433
OK 2A3-18100 A	ZS 436
27300-39000	ZSE 086
27300-39050	ZSE 086
KK137-18-10XB	ZS 511
KK137-18-10XC	ZS 511

KTM	BERU
611 39 006 000	ZS 443

KW	BERU
470 199	ZS 356
470 220	ZS 511
470 261	ZS 274
470 272	ZS 344
470 365	ZS 345
470 377	ZS 354
470 379 S	ZS 350
470 380 S	ZS 365
470 397	ZS 361
470 425	ZSE 062
470 427	ZSE 032
470 429	ZSE 043
470 431	ZSE 059
470 433	ZSE 061
470 434	ZSE 044
470 435	ZSE 063
470 436	ZSE 051
470 437	ZSE 065

LADA	BERU
210137050560	ZS 106
21083705010	ZS 120
2108373491010	ZM 010
2108373491010	ZM 039
2108373491080	ZM 010
21110370501000	ZS 395
21113705010	ZS 395
363 734	ZM 039

LAMBORGHINI	BERU
07M 905 115 E	ZSE 129
4419628	ZM 005

LANCIA	BERU
46403328	ZS 310
46467542	ZS 311
46469863	ZS 309
60504288	ZM 001
60590028	ZM 001
60590029	ZM 001
60755012	ZM 003
60755094	ZM 003
71716152	ZS 119
7582152	ZS 244
7612954	ZS 119
7612955	ZM 040
7663177	ZS 244
7698431	ZS 244
7746152	ZS 244
7746154	ZS 244
82 281 560	ZS 115
82369531	ZM 005
9612955	ZM 040
9940095	ZM 009

LANDROVER	BERU
NEC000070 L	ZS 068
NEC000110 L	ZS 068
NEC000120 L	ZS 501

LANDROVER	BERU
NEC100730 L	ZS 501

LUCAS	BERU
54401850	ZM 008
54403549	ZM 001
54403575	ZM 001
54896	ZM 047
54987086	ZM 018
80428	ZM 047
80334A	ZM 018
80334A	ZM 041
84403	ZM 020
84453	ZM 047
84193	ZM 047
84403D	ZM 020
84453B	ZM 047
84504B	ZM 047
84567	ZM 047
84567B	ZM 047
84890D	ZM 018
84896A	ZM 020
84950A	ZM 020
8490D	ZM 041
84987	ZM 048
84988	ZM 048
DAB 101	ZM 008
DAB 118	ZM 020
DAB 119	ZM 047
DAB 120	ZM 047
DAB 121	ZM 047
DAB 125	ZM 005
DAB 126	ZM 018
DAB 126	ZM 041
DAB 127	ZM 020
DAB 127	ZM 047
DAB 128	ZM 010
DAB 129	ZM 020
DAB 132	ZM 048
DAB 133	ZM 048
DAB 134	ZM 018
DAB 134	ZM 041
DAB 135	ZM 020
DAB 135	ZM 047
DAB 200	ZM 001
DAB 201	ZM 001
DAB 202	ZM 017
DAB 214	ZM 024
DAB 400	ZM 002
DAB 401	ZM 003
DAB 402	ZM 012
DAB 403	ZM 039
DAB 404	ZM 004
DAB 405	ZM 015
DAB 406	ZM 040
DAB 407	ZM 032
DAB 408	ZM 034
DAB 416	ZM 038
DAB 424	ZM 060
DAB 441	ZM 031
DAB 700	ZM 006
DAB 701	ZM 043
DAB 702	ZM 007
DAB 703	ZM 016
DAB 750	ZM 019
DAB 800	ZM 009
DAB 801	ZM 061
DAB 953	ZM 010
DAB 954	ZM 013
DAJ 106	ZM 046
DAJ 204	ZM 022
DAJ 901	ZM 054
DAJ 904	ZM 023
DLB 101	ZS 106
DLB 102	ZS 109
DLB 204	ZS 251
DLB 205	ZS 247
DLB 233	ZS 249
DLB 801	ZS 248
DLJ 431	ZS 356
DMB 1013	ZS 434
DMB 1026	ZS 433
DMB 1075	ZSE 086
DMB 1102	ZS 429

LUCAS	BERU
DMB 408	ZS 354
DMB 808	ZSE 043
DMB 810	ZS 365
DMB 816	ZS 259
DMB 851	ZS 309
DMB 868	ZSE 045
DMB 874	ZS 346
DMB 875	ZS 351
DMB 886	ZSE 046
DMB 893	ZS 367
DMB 897	ZS 387
DMB 903	ZS 375
DMB 907	ZSE 059
DMB 910	ZSE 063
DMB 912	ZSE 044
DMB 970	ZS 355
DMB 984	ZSE 084

LUOSHI	BERU
L620906	ZS 326
L630310	ZSE 502
L740401	ZSE 030
L830106	ZS 380

MAGNETI MARELLI	BERU
060690002010	ZS 106
060705404010	ZS 248
060705409010	ZS 250
060705604010	ZS 244
060705606010	ZS 248
060705738010	ZS 257
060707038010	ZS 323
060708049010	ZS 327
060708149010	ZS 315
060740302010	ZS 320
060792001010	ZS 029
060796105010	ZSE 040
060801008010	ZS 259
064833010010	ZM 005
064833036010	ZM 061
064833040	ZM 009
0940038510	ZM 034
0940038522	ZM 007
0940038570	ZM 010
0941038520	ZM 006
581701010000	ZM 061
581701020000	ZM 061
581701070000	ZM 009
581701080000	ZM 003
60705404	ZS 248
60705409	ZS 250
60705604	ZS 244
60705606	ZS 248
60707038	ZS 323
60708038010	ZS 283
60740303010	ZS 322
60740304010	ZS 321
60740308010	ZS 068
60780002010	ZS 283
60794001010	ZS 079
60801012010	ZS 427
64833031010	ZM 061
64833036	ZM 061
64833100010	ZM 003
64833010	ZM 005
64833032	ZM 002
64833040	ZM 009
64833060	ZM 003
940038500	ZM 002
940038502	ZM 003
940038503	ZM 012
940038504	ZM 013
940038505	ZM 039
940038506	ZM 004
940038506	ZM 004
940038507	ZM 014
940038508	ZM 015
940038509	ZM 032
940038509	ZM 032
940038512	ZM 031
940038518	ZM 017
940038520	ZM 006

MAGNETI MARELLI	BERU
940038521	ZM 005
940038522	ZM 007
940038525	ZM 043
940038526	ZM 016
940038527	ZM 008
940038535	ZM 038
940038542	ZM 019
940038543	ZM 043
940038544	ZM 020
940038545	ZM 047
940038550	ZM 023
940038570	ZM 010
940038571	ZM 018
943251220010	ZM 034
BAE 403 B	ZS 320
BAE 403 C	ZS 322
BAE 403 D	ZS 321
BAE 403 H	ZS 068
BAE 504 L	ZS 250
BAE 506	ZS 244
BAE 506 D	ZS 244
BAE 506 F	ZS 248
BAE 608 F	ZS 259
BAE 700 AK	ZS 323
BAE 800 AK	ZS 283
BAE 800 B	ZS 283
BAE 800 DK	ZS 283
BAE 801 AK	ZS 317
BAE 801 BK	ZS 318
BAE 801 CK	ZS 319
BAE 801 EK	ZS 315
BAE 850	ZS 284
BAE 920 A	ZS 029
BAE 920 AX	ZS 029
BAE 9961 EA	ZSE 040
BAE504D	ZS 248
BK2A	ZS 106
BKL 1 A	ZM 005
BKL 3 B	ZM 061
BKL 3 BD	ZM 061
BKL 4 A	ZM 009
BKL2A	ZM 001
BKL3C	ZM 002
MTR01	ZM 001
MTR02	ZM 003
MTR2	ZM 003
TZP 443 213 221	ZM 060

MAN	BERU
51 25907 0006	WZ 04-2
51 25907 0008	WZ 04-2
51 25919 0016	ZS 297
93 21200 6070	ZS 120

MAPCO	BERU
80042	ZS 283
80043	ZS 244
80100	ZS 251
80103	ZS 354
80401	ZS 249
80402	ZS 232
80402	ZS 341
80403	ZS 258
80404	ZS 257
80501	ZS 532
80530	ZS 277
80531	ZS 376
80560	ZM 059
80562	ZS 356
80563	ZS 449
80570	ZS 511
80571	ZSE 502
80613	ZS 252
80616	ZS 259
80618	ZS 358
80619	ZSE 147
80751	ZS 281
80752	ZS 350
80752	ZS 422
80882	ZS 280
80883	ZSE 043
80885	ZSE 001

MAPCO	BERU
80886	ZSE 030
80888	ZSE 003
80894	ZSE 051

MARSHALL	BERU
ME 72-14	ZS 408

MAZDA	BERU
18E05 18 100	ZS 239
18E05 18 100 A	ZS 239
1E04 18 10X	ZS 350
1E05 18 100 B	ZS 350
58 57 42 49 10	ZM 022
8174 24 910	ZM 022
8574 24 910	ZM 022
AM15 18 V20	ZM 053
B541 18 V20	ZM 025
B6S7 18 10XA	ZS 279
B6S8 10 10XA	ZS 279
BP01 18 251	ZM 050
BP6D 18 100 A	ZSE 084
C201 18 100 A	ZS 350
E730 12 491 0	ZM 053
F829 18 V20	ZM 024
F210 18 100	ZS 274
F210 18 100 B	ZS 274
F211 18 100 A	ZS 274
FP85 18 100 A	ZSE 083
FP85 18 100 B	ZSE 083
FP85 18 100 C	ZSE 083
FPY 118 100	ZSE 083
JF0118100B	ZS 274
K 013-18-100	ZS 434
K 247-18100	ZS 433
K 2A 318 100A	ZS 436
YF091810X	ZS 350

MEAT&DORIA	BERU
0880190	ZSE 140
10013	ZM 007
10302	ZS 283
10303	ZS 029
10304	ZS 248
10305	ZS 244
10306	ZSE 002
10307	ZSE 003
10308	ZSE 001
10310	ZS 361
10311	ZS 234
10314	ZS 281
10315	ZS 259
10320	ZS 361
10324	ZSE 047
10326	ZS 358
10328	ZSE 043
10329	ZSE 030
10331	ZS 320
10333	ZSE 040
10336	ZS 354
10342	ZS 016
10343	ZS 232
10343	ZS 341
10344	ZS 275
10345	ZS 242
10346	ZS 230
10347	ZS 243
10348	ZS 249
10349	ZS 234
10350	ZS 532
10351	ZS 324
10353	ZS 014
10354	ZS 315
10356	ZS 321
10361	ZSE 011
10362	ZS 297
10366	ZS 313
10370	ZS 371
10372	ZSE 031
10373	ZSE 032
10374	ZSE 029
10375	ZS 256

MEAT&DORIA	BERU
10378	ZS 309
10380	ZS 255
10382	ZS 307
10383	ZS 317
10386	ZS 300
10387	ZS 356
10388	ZS 231
10389	ZS 088
10391	ZS 348
10394	ZSE 039
10395	ZS 079
10398	ZS 342
10401	ZSE 502
10405	ZSE 045
10409	ZS 380
10410	ZS 511
10416	ZS 346
10417	ZS 349
10418	ZS 347
10419	ZS 351
10420	ZS 375
10433	ZS 274
10439	ZS 501
10458	ZS 521
10460	ZSE 059
10462	ZS 387
10470	ZSE 046
10471	ZSE 048
10472	ZS 352
10473	ZS 353
10478	ZSE 030
10480	ZS 427
10483	ZS 359
10498	ZSE 063
10500	ZSE 056
10501	ZSE 031
10503	ZSE 065
10504	ZSE 061
10505	ZSE 062
10541	ZS 095
10573	ZS 395
10576	ZS 436
10599	ZSE 067
10599	ZSE 126
10602	ZSE 137
10701	ZS 439
10702	ZS 440
10706	ZS 441
10709	ZSE 130

MERCEDES	BERU
000 150 04 80	ZS 313
000 150 05 80	ZS 313
000 150 13 80	ZSE 146
000 150 15 80	ZS 053
000 150 17 80	ZS 041
000 150 19 80	ZSE 140
000 150 25 80	ZS 077
000 150 27 80	ZSE 140
000 150 28 80	ZS 041
000 150 29 80	ZS 053
000 158 00 03	ZS 106
000 158 02 03	ZS 106
000 158 06 03	ZS 115
000 158 08 45	WZ 09-2
000 158 13 45	WZ 04-2
000 158 17 45	WZ 18-2
000 158 18 45	WZ 18-2
000 158 20 45	WZ 04-2
000 158 21 45	WZ 06-2
000 158 26 03	ZS 109
000 158 27 03	ZS 109
000 158 28 03	ZS 400
000 158 32 03	ZS 106
000 158 34 03	ZS 106
000 158 37 03	ZS 109
000 158 38 03	ZS 106
000 158 39 03	ZS 109
000 158 40 03	ZS 117
000 158 45 03	ZS 118
000 158 48 03	ZS 296
000 158 49 03	ZS 109
000 158 56 03	ZS 298

MERCEDES	BERU
000 158 58 03	ZS 298
000 158 61 03	ZS 296
000 158 62 03	ZS 339
000 158 64 03	ZS 298
000 158 65 03	ZS 299
000 158 68 03	ZS 313
000 158 71 03	ZS 340
000 158 73 03	ZS 297
000 158 75 03	ZS 340
000 158 77 03	ZS 304
000 158 78 03	ZS 297
001 545 86 32	ZM 004
002 545 18 32	ZM 004
002 545 58 32	ZM 004
002 545 59 32	ZM 004
002 545 90 32	ZM 004
003 158 50 01	ZSE 004
003 545 16 32	ZM 004
003 545 40 32	ZM 004
160 158 77 03	ZS 304
272 906 00 60	ZSE 140
607 158 00 03	ZS 106
A 000 150 04 80	ZS 313
A 000 150 05 80	ZS 313
A 000 150 13 80	ZSE 146
A 000 150 15 80	ZS 053
A 000 150 17 80	ZS 041
A 000 150 19 80	ZSE 140
A 000 150 25 80	ZS 077
A 000 150 27 80	ZSE 140
A 000 150 28 80	ZS 041
A 000 150 29 80	ZS 053
A 000 158 40 03	ZS 117
A 000 158 45 03	ZS 118
A 000 158 48 03	ZS 296
A 000 158 61 03	ZS 296
A 000 158 62 03	ZS 339
A 000 158 64 03	ZS 298
A 000 158 65 03	ZS 299
A 000 158 68 03	ZS 313
A 000 158 71 03	ZS 340
A 000 158 73 03	ZS 297
A 000 158 75 03	ZS 340
A 000 158 78 03	ZS 297
A 001 545 86 32	ZM 004
A 002 545 18 32	ZM 004
A 002 545 58 32	ZM 004
A 002 545 59 32	ZM 004
A 002 545 90 32	ZM 004
A 003 158 50 01	ZSE 004
A 003 545 16 32	ZM 004
A 003 545 17 32	ZM 004
A 272 906 00 60	ZSE 140

METZGER	BERU
0880002	ZS 259
0880004	ZS 342
0880006	ZS 451
0880007	ZS 358
0880008	ZSE 147
0880010	ZSE 151
0880012	ZS 427
0880014	ZSE 143
0880040	ZSE 152
0880041	ZSE 153
0880051	ZS 340
0880052	ZSE 146
0880061	ZSE 004
0880063	ZSE 149
0880073	ZS 387
0880076	ZSE 502
0880078	ZSE 051
0880090	ZS 501
0880100	ZSE 001
0880101	ZSE 030
0880102	ZSE 043
0880103	ZSE 003
0880125	ZSE 142
0880130	ZS 382
0880139	ZSE 144
0880161	ZSE 145
0880171	ZSE 148
0880172	ZS 422

<b>METZGER</b>	<b>BERU</b>
0880175	ZS 449
0880180	ZS 095
0880191	ZSE 150
0880198	ZSE 126
0880200	ZS 052
0880204	ZSE 137
0880250	ZS 324
0880350	ZS 283
0880356	ZS 320
0880400	ZSE 019
0880401	ZSE 055
VM-M308	ZS 351
WM-M003	ZS 344
WM-M102	ZSE 043
WM-M301	ZSE 047
WM-M305	ZSE 045
WM-M306	ZSE 046
WM-M310	ZS 353

<b>MEYLE</b>	<b>BERU</b>
014 158 0000	ZS 340
014 885 0006	ZSE 146
100 885 0007	ZSE 051
100 885 0040	ZSE 030
100 905 0007	ZSE 001
100 905 0019	ZSE 043
100 905 0021	ZSE 003
100 905 0025	ZSE 142
161 488 50002	ZS 052
214 800 0000	ZS 115
214 800 0001	ZS 283
214 885 0004	ZS 320
314 131 0000	ZS 302
314 139 0000	ZS 014
314 885 0000	ZS 324
514 885 0004	ZS 429
614 885 0004	ZS 342
614 885 0006	ZS 259
614 885 0007	ZS 427
714 885 0001	ZS 387
714 885 0003	ZS 422
714 885 0000	ZS 350

<b>MITSUBISHI</b>	<b>BERU</b>
112955	ZM 049
132243	ZM 049
2371771	ZM 049
5201 A	ZM 052
9311600	ZS 395
CY-GS 065A	ZM 057
EJN 902	ZM 053
HQ808700	ZSE 010
J007X00871	ZM 024
J007X00971	ZM 049
J007X01271	ZM 049
J007X03471	ZM 052
J009T02071	ZM 049
J117	ZM 024
J120	ZM 025
J121	ZM 049
J131	ZM 048
J152	ZM 053
J153	ZM 051
J170	ZM 025
J170-9910A	ZM 025
J304	ZM 052
J701	ZM 050
J9T03372	ZM 049
M04557468	ZS 379
M05269670	ZS 380
MD 001800	ZS 106
MD 001804	ZS 106
MD 003821	ZS 110
MD 017612	ZS 106
MD 104696	ZS 261
MD 112479	ZM 049
MD 113551	ZS 282
MD 114994	ZS 263
MD 129550	ZM 049
MD 1312243	ZM 049
MD 131711	ZS 282
MD 164475	ZM 049

<b>MITSUBISHI</b>	<b>BERU</b>
MD 607478	ZM 022
MD 607814	ZM 053
MD 611384	ZM 053
MD 618268	ZM 049
MD 618293	ZM 051

<b>MOTORCRAFT</b>	<b>BERU</b>
DY 425	ZM 019
DYE 923	ZM 022
EDG 41	ZS 238
EDG 42	ZS 238
EDY 7	ZM 019

<b>MOTOROLA</b>	<b>BERU</b>
AM 2	ZM 005
GM 1	ZM 005

<b>MV AGUSTA</b>	<b>BERU</b>
8000A6700	ZS 378

<b>MWM</b>	<b>BERU</b>
6 044 01 1 0013	WZ 04-2
6 0579 120 0002	ZS 106

<b>NGK</b>	<b>BERU</b>
48000	ZSE 001
48001	ZS 350
48001	ZS 365
48001	ZS 422
48002	ZS 052
48003	ZSE 030
48004	ZS 427
48005	ZSE 043
48006	ZS 259
48008	ZS 016
48009	ZS 302
48011	ZS 342
48012	ZSE 026
48013	ZS 283
48014	ZSE 045
48015	ZSE 059
48016	ZSE 047
48017	ZSE 146
48018	ZS 340
48019	ZS 242
48020	ZS 243
48021	ZS 237
48021	ZS 238
48021	ZS 239
48021	ZS 281
48022	ZS 358
48023	ZS 381
48024	ZS 297
48025	ZS 234
48026	ZS 354
48027	ZS 387
48028	ZS 317
48029	ZS 252
48030	ZS 341
48031	ZS 347
48032	ZS 348
48033	ZS 324
48034	ZS 320
48035	ZSE 063
48036	ZS 014
48038	ZSE 029
48039	ZSE 002
48040	ZSE 051
48041	ZSE 032
48042	ZSE 142
48043	ZSE 147
48045	ZS 241
48046	ZS 311
48047	ZSE 031
48049	ZSE 008
48050	ZS 313
48051	ZS 256
48052	ZS 029
48053	ZS 300

<b>NGK</b>	<b>BERU</b>
48054	ZS 275
48055	ZS 501
48056	ZS 344
48057	ZS 253
48058	ZS 246
48058	ZS 255
48060	ZS 315
48060	ZS 327
48061	ZS 322
48062	ZS 247
48063	ZS 408
48064	ZS 244
48065	ZSE 044
48066	ZS 249
48067	ZS 231
48068	ZS 245
48068	ZS 254
48071	ZS 352
48072	ZS 351
48073	ZS 346
48074	ZSE 048
48075	ZS 343
48076	ZSE 046
48077	ZS 353
48078	ZS 345
48079	ZS 371
48082	ZSE 009
48083	ZS 338
48085	ZS 304
48086	ZS 372
48087	ZSE 004
48088	ZSE 061
48089	ZS 041
48091	ZS 068
48091	ZS 088
48092	ZS 316
48093	ZS 356
48096	ZS 451
48098	ZS 276
48099	ZS 278
48100	ZS 502
48101	ZSE 013
48104	ZS 361
48106	ZS 306
48108	ZS 325
48110	ZS 370
48111	ZS 532
48112	ZS 274
48113	ZS 263
48114	ZSE 040
48115	ZS 118
48115	ZS 296
48116	ZS 449
48117	ZS 277
48119	ZS 308
48120	ZS 367
48122	ZSE 021
48123	ZS 250
48126	ZS 359
48127	ZSE 019
48131	ZS 053
48132	ZS 257
48133	ZS 307
48134	ZSE 502
48138	ZS 318
48139	ZSE 081
48140	ZSE 055
48144	ZS 368
48145	ZS 450
48147	ZSE 144
48149	ZS 309
48150	ZS 037
48151	ZSE 149
48152	ZS 261
48154	ZS 428
48155	ZS 337
48156	ZSE 037
48158	ZS 279
48159	ZSE 150
48160	ZS 267
48161	ZSE 148
48162	ZSE 056
48163	ZS 323
48165	ZSE 065

<b>NGK</b>	<b>BERU</b>
48168	ZS 310
48169	ZS 079
48170	ZS 266
48171	ZS 429
48172	ZS 321
48173	ZS 264
48176	ZSE 011
48178	ZSE 152
48183	ZSE 136
48185	ZS 380
48190	ZS 319
48192	ZSE 153
48193	ZS 301
48195	ZS 379
48197	ZS 230
48206	ZSE 143
48207	ZS 077
48208	ZSE 083
48216	ZSE 145
48220	ZS 405
48221	ZS 031
48223	ZSE 084
48226	ZSE 080
48234	ZSE 039
48236	ZS 106
48243	ZSE 071
48244	ZSE 073
48259	ZS 432
48262	ZS 431
48270	ZS 436
48276	ZS 410
48281	ZSE 072
48284	ZSE 066
48286	ZS 095
48291	ZS 434
48294	ZS 433
48298	ZS 106
48300	ZS 109
48302	ZS 115
48303	ZS 115
48308	ZS 119
48311	ZS 299
48312	ZS 395
48313	ZSE 087
48314	ZSE 086
48316	ZS 521
48318	ZS 508
48324	ZS 419
48326	ZS 430
48327	ZSE 074
48329	ZSE 076
48330	ZSE 077
48331	ZSE 075
48332	ZSE 079
48333	ZSE 082
48337	ZSE 140
48339	ZS 115
48340	ZS 126
48342	ZS 106
48343	ZS 124
48346	ZS 127
48347	ZSE 088
48350	ZSE 132
48356	ZSE 078
48357	ZS 282
U1001	ZSE 001
U1002	ZS 252
U1003	ZSE 002
U1004	ZS 275
U1005	ZS 253
U1007	ZS 247
U1008	ZS 244
U1009	ZS 249
U1012	ZS 316
U1013	ZS 356
U1016	ZS 276
U1017	ZS 278
U1020	ZS 532
U1021	ZS 274
U1022	ZS 263
U1023	ZS 118
U1023	ZS 296
U1024	ZS 277
U1026	ZS 250

NGK	BERU
U1029	ZS 257
U1034	ZS 261
U1035	ZSE 037
U1036	ZS 279
U1037	ZSE 011
U1056	ZS 106
U1061	ZS 106
U1063	ZS 109
U1065	ZS 115
U1066	ZS 115
U1071	ZS 119
U1074	ZS 299
U1075	ZS 419
U1076	ZS 115
U1077	ZS 126
U1079	ZS 106
U1080	ZS 124
U1083	ZS 127
U1084	ZS 282
U2001	ZS 350
U2001	ZS 365
U2001	ZS 422
U2004	ZSE 026
U2005	ZS 237
U2005	ZS 238
U2005	ZS 239
U2005	ZS 281
U2006	ZS 234
U2007	ZS 354
U2008	ZS 387
U2009	ZS 341
U2011	ZSE 029
U2013	ZSE 008
U2014	ZS 029
U2015	ZS 300
U2016	ZS 344
U2017	ZS 231
U2019	ZS 345
U2020	ZS 371
U2023	ZS 372
U2024	ZSE 004
U2025	ZS 451
U2026	ZSE 013
U2027	ZS 306
U2028	ZS 325
U2029	ZS 370
U2030	ZS 307
U2032	ZS 450
U2033	ZS 037
U2035	ZS 267
U2038	ZS 079
U2039	ZS 266
U2040	ZS 264
U2041	ZS 380
U2043	ZS 301
U2044	ZS 379
U2046	ZS 230
U2049	ZS 405
U2065	ZS 395
U2067	ZS 521
U3001	ZS 283
U3002	ZS 242
U3003	ZS 243
U3004	ZS 297
U3005	ZS 317
U3006	ZS 313
U3007	ZS 246
U3007	ZS 255
U3008	ZS 315
U3008	ZS 327
U3009	ZS 245
U3009	ZS 254
U3010	ZS 304
U3012	ZS 318
U3014	ZS 319
U4001	ZS 501
U4002	ZS 502
U4004	ZS 361
U4005	ZS 308
U4006	ZSE 502
U4007	ZS 309
U4009	ZS 429
U4010	ZSE 136
U4011	ZSE 083

NGK	BERU
U4013	ZSE 084
U4019	ZS 436
U4020	ZS 434
U4021	ZS 433
U4022	ZSE 087
U4023	ZSE 086
U4024	ZS 430
U4026	ZS 340
U5001	ZS 052
U5002	ZSE 030
U5003	ZSE 043
U5004	ZS 016
U5005	ZS 302
U5006	ZSE 059
U5008	ZS 347
U5009	ZS 324
U5010	ZS 320
U5011	ZSE 063
U5012	ZS 014
U5013	ZSE 051
U5014	ZSE 032
U5015	ZSE 033
U5015	ZSE 142
U5016	ZS 311
U5017	ZSE 031
U5018	ZS 322
U5019	ZS 408
U5020	ZSE 044
U5021	ZS 346
U5022	ZSE 009
U5024	ZSE 061
U5025	ZS 041
U5026	ZS 068
U5026	ZS 088
U5030	ZS 449
U5031	ZS 367
U5032	ZSE 021
U5033	ZSE 019
U5034	ZS 053
U5036	ZSE 081
U5037	ZSE 055
U5038	ZS 368
U5039	ZSE 144
U5040	ZS 428
U5041	ZS 337
U5043	ZSE 056
U5044	ZS 323
U5046	ZSE 065
U5047	ZS 310
U5048	ZS 321
U5052	ZSE 148
U5055	ZSE 143
U5056	ZS 077
U5058	ZSE 145
U5059	ZS 031
U5061	ZSE 080
U5070	ZSE 071
U5071	ZSE 073
U5078	ZS 432
U5079	ZS 431
U5089	ZS 410
U5092	ZSE 072
U5094	ZSE 066
U5096	ZS 095
U5107	ZSE 074
U5109	ZSE 076
U5110	ZSE 077
U5111	ZSE 075
U5112	ZSE 079
U5113	ZSE 082
U5117	ZSE 140
U5119	ZSE 088
U5123	ZSE 132
U5127	ZSE 078
U6001	ZS 427
U6002	ZS 259
U6003	ZS 342
U6004	ZSE 045
U6005	ZSE 047
U6006	ZSE 146
U6007	ZS 358
U6008	ZS 381
U6009	ZS 348
U6010	ZSE 147

NGK	BERU
U6011	ZS 241
U6012	ZS 256
U6013	ZS 352
U6014	ZS 351
U6015	ZSE 048
U6016	ZS 343
U6017	ZSE 046
U6018	ZS 353
U6019	ZS 338
U6020	ZSE 040
U6022	ZS 359
U6027	ZSE 149
U6028	ZSE 150
U6029	ZSE 152
U6030	ZSE 153
U6033	ZSE 039
U6035	ZS 508

NISSAN	BERU
22020-0B000	ZM 048
22020-15M00	ZM 046
22020-15M20	ZM 046
22020-53J10	ZM 048
22020-53J20	ZM 048
22020-55Y00	ZM 048
22020-56E11	ZM 048
22020-56E16	ZM 048
22020-56E17	ZM 048
22020-70J00	ZM 048
22020-71J00	ZM 048
22020-D0210	ZM 052
22020-P4005	ZM 046
22433-0B00	ZS 277
22433-0B000	ZS 277
22433-0B001	ZS 277
22433-0B010	ZS 277
22433-14800	ZS 106
22433-14805	ZS 106
22433-14806	ZS 106
22433-14810	ZS 106
22433-14811	ZS 106
22433-14815	ZS 106
22433-14816	ZS 106
22433-14900	ZS 106
22433-14905	ZS 106
22433-31300	ZS 106
22433-31303	ZS 106
22433-43110	ZS 109
22433-51J10	ZS 277
22433-53F00	ZS 376
22433-53J20	ZS 277
22433-55S10	ZS 277
22433-55Y00	ZS 376
22433-56E11	ZS 277
22433-56E12	ZS 277
22433-58000	ZS 106
22433-65Y10	ZS 376
22433-78500	ZS 106
22433-78510	ZS 106
22433-79011	ZS 106
22433-79012	ZS 106
22433-8J115	ZSE 079
22433-8J11C	ZSE 079
22433-F4302	ZS 326
22433-L1610	ZS 106
22433-L6801	ZS 106
22448-00QAA	ZS 052
22448-00QAC	ZS 354
22448-00QAE	ZS 052
22448-00QAF	ZS 375
22448-0C801	ZS 277
22448-0C802	ZS 277
22448-1C701	ZS 376
22448-1F700	ZS 337
22448-2Y000	ZSE 078
22448-2Y001	ZSE 075
22448-2Y005	ZSE 082
22448-2Y006	ZSE 077
22448-2Y007	ZSE 077
22448-31U00	ZSE 073
22448-31U01	ZSE 073
22448-31U05	ZSE 071
22448-31U06	ZSE 071

NISSAN	BERU
22448-31U15	ZSE 071
22448-31U16	ZSE 071
22448-37J10	ZS 376
22448-37J11	ZS 376
22448-37J20	ZS 376
22448-3H000	ZSE 074
22448-4M500	ZSE 021
22448-4M50A	ZSE 021
22448-4W011	ZSE 076
22448-6N000	ZSE 081
22448-6N002	ZSE 081
22448-6N010	ZSE 081
22448-6N011	ZS 052
22448-6N012	ZSE 081
22448-6N015	ZSE 081
22448-7S015	ZSE 134
22448-8H310	ZSE 080
22448-8H311	ZSE 080
22448-8H314	ZSE 080
22448-8H315	ZSE 080
22448-8J11C	ZSE 079
22448-AL615	ZSE 132
22448-AL61C	ZSE 132
22448-D4000	ZS 277
22448-ED00 0	ZSE 088
22448-ED800	ZSE 056
22448-ED800EP	ZSE 056
22448-JA00 A	ZSE 088
22448-JA00 C	ZSE 088
PRW1A	ZM 048
PRW2	ZM 048
PRW2A	ZM 048
PRW3	ZM 048

NPS	BERU
H536111	ZSE 502

NSU	BERU
376 81 50 901	ZS 106
380 83 50 701	ZS 109

OPEL	BERU
10 45 7075	ZSE 026
11 03 872	ZSE 026
11 03 905	ZSE 026
12 08 002	ZS 252
12 08 003	ZS 253
12 08 004	ZS 252
12 08 006	ZS 355
12 08 007	ZS 451
12 08 008	ZS 342
12 08 009	ZS 106
12 08 011	ZS 106
12 08 012	ZSE 147
12 08 013	ZS 106
12 08 014	ZS 106
12 08 015 (alt)	ZS 115
12 08 017	ZS 115
12 08 018	ZS 106
12 08 020	ZS 338
12 08 021	ZS 427
12 08 028	ZS 359
12 08 033	ZM 002
12 08 033	ZM 015
12 08 036	ZS 252
12 08 037	ZM 002
12 08 040	ZM 032
12 08 040	ZM 034
12 08 043	ZM 001
12 08 045	ZM 034
12 08 046	ZS 125
12 08 047	ZS 125
12 08 048	ZS 252
12 08 049	ZM 001
12 08 050	ZM 001
12 08 053	ZS 127
12 08 054	ZS 253
12 08 055	ZM 001
12 08 056	ZM 015
12 08 057	ZM 034
12 08 061	ZS 355

OPEL	BERU
12 08 063	ZSE 026
12 08 065	ZS 300
12 08 068	ZS 301
12 08 070	ZS 253
12 08 071	ZS 344
12 08 074	ZM 026
12 08 075	ZS 306
12 08 076	ZS 450
12 08 209	ZSE 152
12 08 210	ZSE 153
12 08 213	ZSE 150
12 08 241	ZM 002
12 08 243	ZM 015
12 08 246	ZM 002
12 08 247	ZM 032
12 08 248	ZM 001
12 08 306	ZS 358
12 08 307	ZS 259
12 08 325	WZ 09-2
12 08 56	ZM 001
12 11 560	ZM 006
12 11 561	ZM 007
12 11 582	ZM 016
12 11 591	ZM 016
12 37 306	ZM 034
12 37 334	ZM 041
12 37 464	ZM 018
12 37 464	ZM 041
12 37 504	ZM 016
16 05 130	ZM 043
18 759 90	ZM 005
24 420 584	ZS 338
24 420 622	ZS 359
44 08 389	ZS 052
44 13 233	ZS 052
62 35 037	ZSE 151
62 35 124	ZSE 149
62 37 777	ZM 041
6237752	ZM 006
6237754	ZM 007
83 093 1	ZM 005
90 006 499	ZM 015
90 062 964	ZM 015
90 187 341	ZM 002
90 188 755	ZM 015
90 241 775	ZM 034
90 296 502	ZM 034
90 297 486	ZM 034
90 297 487	ZS 125
90 297 786	ZM 034
90 320 586	ZM 034
90 348 296	ZS 125
90 350 787	ZM 034
90 358 386	ZS 301
90 424 480	ZSE 151
90 443 900	ZS 300
90 444 148	ZS 301
90 444 184	ZS 301
90 444 650	ZM 026
90 449 572	ZS 300
90 492 255	ZS 451
90 506 102	ZS 450
90 511 450	ZS 451
90 541 062	ZS 306
90 543 253	ZSE 147
90 560 110	ZSE 147
90 563 160	ZS 306
90 564 334	ZSE 150
91 159 996	ZS 052
91 532 50	ZSE 149
91 958 19	ZSE 150
91 988 34	ZSE 151
93 172 030	ZSE 149

OPTIMAL	BERU
SPE-116209	ZSE 003

PAL	BERU
TZP 443 213 221 020	ZM 060

PERKINS	BERU
4173 D 004	ZS 049

PEUGEOT	BERU
5927.90	ZM 001
5940.29	ZS 250
5945.02	ZM 001
5945.03	ZM 001
5945.24	ZM 001
5945.25	ZM 001
5945.31	ZM 001
5945.33	ZM 001
5945.39	ZM 001
5945.48	ZM 001
5945.51	ZM 015
5945.54	ZM 026
5945.60	ZM 001
5970.10	ZS 106
5970.13	ZS 110
5970.15	ZS 110
5970.17	ZS 400
5970.26	ZS 106
5970.42	ZS 257
5970.43	ZS 247
5970.45	ZS 249
5970.47	ZS 258
5970.48	ZS 341
5970.49	ZS 231
5970.50	ZS 323
5970.51	ZS 256
5970.53	ZS 234
5970.55	ZS 346
5970.56	ZS 241
5970.57	ZS 343
5970.60	ZS 341
5970.64	ZSE 143
5970.70	ZS 232
5970.72 (ohne Stecker)	ZS 381
5970.73	ZS 349
5970.74	ZS 381
5970.75	ZS 348
5970.77	ZS 347
5970.78	ZSE 047
5970.79	ZSE 047
5970.80	ZSE 045
5970.81	ZSE 046
5970.84	ZS 351
5970.87	ZS 352
5970.90	ZSE 048
5970.92	ZS 353
5970.94	ZS 347
5970.97	ZSE 048
5970.98	ZS 348
5970.99	ZSE 045
5970.A2	ZS 241
5970.A3	ZSE 046
5970.A4	ZS 349
5970.A5	ZS 351
5970.A6	ZS 353
5970.A7	ZS 256
5970.A8	ZSE 047
5970.A9	ZS 381
7910035100	ZM 001
91504912	ZM 001
9150494480	ZM 001
9150633880	ZM 001
94048070	ZM 015
97532831	ZM 001

PEX	BERU
110.017	ZS 356
110.026	ZS 350
110.037	ZSE 030
110.044	ZS 345
111.034	ZSE 043
117.20	ZS 354

PIAGGIO	BERU
58120R	ZS 078
641007	ZS 440
828817	ZS 078
BD.0014694.A	ZS 078

PIAGGIO	BERU
BD.0081419.A	ZS 078

PORSCHE	BERU
547 602 102 00	ZS 109
616 602 109 00	ZS 106
901 602 102 00	ZS 109
901 602 102 01	ZS 115
901 602 502 01	ZS 109
911 099 600 15	WZ 04-2
928 602 116 00	ZS 122
928 602 501 00	ZS 115
928 602 502 00	ZS 106
928 602 503 00	ZS 400
928 602 702 02	ZS 400
928 602 70601	ZM 015
948 602 104 00	ZSE 012
948 602 104 01	ZSE 012
948 602 104 02	ZSE 042
948 602 104 03	ZSE 012
948 602 104 04	ZSE 042
948 602 104 05	ZSE 012
948 602 104 06	ZSE 042
948 602 104 07	ZSE 012
948 602 104 08	ZSE 012
948 602 104 09	ZSE 012
948 602 104 10	ZSE 042
948 602 104 11	ZSE 042
955 602 101 03	ZSE 044
955 602 101 05	ZSE 044
958 602 101 00	ZSE 044
958 602 102 00	ZSE 032
980 602 904 00	ZSE 054
980 602 904 01	ZSE 054
993 602 071 00	ZS 357
993 602 071 01	ZS 357
993 602 706 00	ZM 026
993 602 706 01	ZM 026
996 602 101 01	ZS 031
996 602 102 00	ZS 031
996 602 104.00	ZS 036
997 602 107 00	ZS 031
997 602 104 00	ZS 036
9A1 602 104 00	ZSE 052
9A1 602 104 01	ZSE 052
9A1 602 104 02	ZSE 052
9A1 602 104 03	ZSE 052
9A1 602 104 04	ZSE 052

PROTON	BERU
A2C 5328 3940	ZS 438

PUCH	BERU
721 1 85 373 0	WZ 04-2
721 1 85 376 0	WZ 04-2

PVL	BERU
101411	ZS 121
101417	ZS 120
101425	ZS 119
411604	ZS 121
417604	ZS 120
425604	ZS 119
470901	ZS 120
470922	ZS 121
470939	ZS 119

RENAULT	BERU
08 54 243 200	ZS 106
08 54 269 800	ZS 106
08 54 337 600	ZS 106
22 43 32428R	ZSE 131
22 43 36134R	ZS 354
22 43 37085R	ZSE 066
22448-ED00 0	ZSE 088
22448-JA00 A	ZSE 088
22448-JA00 C	ZSE 088
2526180A	ZS 052
60 00 581 617	ZS 234
74 01 269 084	ZM 002

RENAULT	BERU
74 01 275 174	ZSE 037
77 00 100 589	ZS 242
77 00 100 643	ZS 243
77 00 107 177	ZS 052
77 00 107 269	ZS 315
77 00 113 357	ZS 052
77 00 113 357 A	ZS 052
77 00 274 008	ZS 354
77 00 552 370	ZS 106
77 00 669 324	ZS 110
77 00 749 450	ZS 250
77 00 854 306	ZS 317
77 00 854 307	ZS 318
77 00 858 138	ZS 250
77 00 858 320	ZS 319
77 00 863 020	ZS 254
77 00 863 021	ZS 255
77 00 865 923	ZS 254
77 00 872 265	ZS 317
77 00 872 692	ZS 318
77 00 872 693	ZS 319
77 00 872 834	ZS 345
77 00 875 000	ZS 052
77 01 021 955	ZM 005
77 01 031 135	ZS 251
77 01 031 135	ZS 316
77 01 041 607	ZS 245
77 01 041 608	ZS 246
77 01 205 906	ZS 343
77 01 348 252	ZS 106
77 01 479 027	ZS 347
77 02 218 697	ZS 250
82 00 141 149	ZS 345
82 00 154 186	ZS 052
82 00 154 186 A	ZS 052
82 00 208 611	ZS 052
82 00 360 911	ZS 375
82 00 380 267	ZS 052
82 00 405 098	ZS 052
82 00 568 671	ZS 052
82 00 702 693	ZS 325
82 00 702 693	ZS 375
82 00 726 341	ZSE 066
82 00 765 882	ZS 052
82 00 959 964	ZSE 066
96 33 00 1580	ZS 347
96 64 401 880	ZS 347

ROLLS ROYCE	BERU
UD 70828	ZS 117

ROVER	BERU
BAU5100	ZM 047
BAU5538	ZM 047
BNP3661	ZM 054
CKP7061	ZM 054
ERR6045	ZS 234
GCL195	ZS 275
GC161	ZS 276
NEC000070	ZS 088
NEC000110	ZS 088
NEC000120	ZS 501
NEC000130	ZS 502
NEC100530	ZS 275
NEC100730	ZS 501
NEC100870	ZS 502
NEC101000	ZS 302
NEC101000L	ZS 437
NEC101010L	ZS 435
RTC 5089	ZM 047

S.I.D.A.T.	BERU
85.30001	ZSE 502
85.30020	ZS 521
85.30109	ZS 259
85.30110	ZSE 063
85.30111	ZSE 047
85.30163	ZSE 031
85.30165	ZSE 030
85.30190	ZS 079
85.30193	ZS 088



S.I.D.A.T.	BERU
85.30195	ZSE 065
85.30196	ZSE 061
85.30197	ZSE 062
85.30218	ZS 532
85.30250	ZS 095
85.30268	ZS 427
85.30273	ZS 433
85.30275	ZS 501
85.30292	ZS 434
85.30347	ZS 395
85.30366	ZSE 126
85.30368	ZSE 137
85.30373	ZSE 140
85.30395	ZS 439
85.30396	ZS 440
85.30400	ZS 441
85.30403	ZSE 130

SAAB	BERU
42 26 031	ZS 127
47 70 046	ZS 301
51 71 111	ZS 127
71 31 71	WZ 09-2
73 08 604	ZS 106
73 08 737	ZS 106
73 09 859	ZS 115
75 38 796	ZM 029
75 03 600	ZM 015
83 00 584	ZS 115
85 02 098	ZS 115
85 06 636	ZS 115
85 22 328	ZS 106
85 73 826	ZM 002
85 73 834	ZS 121
89 80 534	ZM 012
93 90 220	ZM 002
95 73 834	ZS 121

SACHS	BERU
000 158 27 03	ZS 109
000 158 32 03	ZS 106
000 158 34 03	ZS 105
000 158 37 03	ZS 109
000 158 39 03	ZS 109
000 158 49 03	ZS 109
1 983 006 000	ZS 109

SAGEM	BERU
21595273-2	ZS 052
21603121-9	ZS 052
2526009	ZS 257
2526009 A	ZS 257
2526015	ZS 248
2526015 A	ZS 248
2526024	ZS 258
2526024 A	ZS 258
2526026	ZS 249
2526026 A	ZS 249
2526030	ZS 244
2526030 A	ZS 244
2526034	ZS 250
2526034 A	ZS 250
2526048	ZS 251
2526048 A	ZS 251
2526049	ZS 253
2526049 A	ZS 253
2526050	ZS 252
2526050 A	ZS 252
2526051	ZS 254
2526051 A	ZS 254
2526052	ZS 255
2526052 A	ZS 255
2526055 A	ZS 344
2526059	ZS 256
2526059 A	ZS 256
2526078 B	ZS 345
2526087	ZS 241
2526087 A	ZS 241
2526110	ZS 245
2526110 A	ZS 245
2526111	ZS 246

SAGEM	BERU
2526111 A	ZS 246
2526114	ZS 242
2526114 A	ZS 242
2526115	ZS 243
2526115 A	ZS 243
2526118 A	ZS 348
2526131 A	ZS 351
2526151 A	ZS 354
2526180 A	ZS 052
2526182 A	ZSE 045
2526182 B	ZSE 045
2526210	ZSE 046
2526210 A	ZSE 046
2528208 B	ZSE 047
520073	ZS 247
8200154186 A	ZS 052
8200380267	ZS 052
B 6039	ZS 231
B 6051	ZS 254
B 6052	ZS 255
B 6059	ZS 256
B 6087	ZS 241
B 6110	ZS 245
B 6111	ZS 246
B 6114	ZS 242
B 6115	ZS 243
B 6162	ZS 247
B 6163	ZS 257
B 6167	ZS 249
B 6168	ZS 250
B 6171	ZS 251
B 6172	ZS 252
B 6185	ZS 258
B 6186	ZS 244
B 6192	ZS 253

SAIPA	BERU
5WY2809	ZS 513
5WY2809 A	ZS 513
5WY2837A	ZS 516

SATURN	BERU
21020180	ZS 421

SCANIA	BERU
1789358	ZS 297
2573826	ZM 002
30584237	ZS 127
7503600	ZM 015

SEAT	BERU
032 905 106	ZSE 003
032 905 106 B	ZSE 003
3939219	ZM 001
3980641	ZM 001
867 905 104	ZSE 001
867 905 105 A	ZSE 002
SE028915.000B	ZS 327
XO 339678.30	ZM 015
XO 394160.00	ZM 002
XO 396783.60	ZM 002

SEV	BERU
73503702	ZM 001

SHANGHAI HUIZHONG	BERU
NEC90012A	ZS 501
NEC90013A	ZS 502

SIEMENS	BERU
175607	ZM 001
2576 12.70.01	ZM 002
5 WK 6	ZM 038
5 WK 6105	ZM 002
5 WK9 0611	ZS 344
5 WKG 222	ZM 041

SIEMENS	BERU
5 WKG 6208	ZM 041
5WK 6101	ZM 002
6116	ZM 038

SKODA	BERU
004 050 016	ZSE 001
032 905 106	ZSE 003
032 905 106 B	ZSE 003
03D 905 115	ZSE 059
03D 905 115 A	ZSE 059
03D 905 115 B	ZSE 059
03D 905 115 C	ZSE 059
03D 905 115 D	ZSE 059
03D 905 115 E	ZSE 059
03D 905 115 F	ZSE 059
03D 905 115 G	ZSE 059
03D 905 715 A	ZSE 059
115 915 080	ZM 060
6 NO 905 104	ZSE 001

SMART	BERU
000 3100 V003	ZS 304
000 3100 V004	ZS 304
000 3100 V005	ZS 304
C 000 3100 V003	ZS 304
C 000 3100 V004	ZS 304
C 000 3100 V005	ZS 304
Q 000 3100 V005 000000	ZS 304

SSANGYONG	BERU
A 172 158 00 03	ZS 537
A 172 158 01 03	ZS 537

STANDARD	BERU
12101	ZSE 126
12102	ZSE 137
12125	ZS 395
12200	ZS 252
12202	ZS 252
12305	ZS 258
12404	ZSE 071
12405	ZSE 073
12409	ZSE 087
12411	ZSE 132
12412	ZSE 086
12415	ZSE 133
12423	ZS 521
12428	ZS 372
12449	ZS 436
12459	ZS 410
12474	ZS 430
12476	ZSE 074
12478	ZSE 076
12479	ZSE 077
12481	ZSE 079
12482	ZSE 082
12589	ZS 242
12596	ZS 354
12598	ZS 300
12602	ZS 248
12605	ZS 248
12607	ZS 243
12608	ZS 014
12609	ZS 302
12609	ZS 437
12611	ZS 274
12613	ZS 232
12613	ZS 341
12614	ZS 281
12615	ZS 282
12616	ZS 231
12617	ZS 263
12618	ZS 276
12619	ZS 283
12621	ZSE 002
12622	ZS 014
12623	ZS 234
12624	ZS 279
12626	ZS 252
12635	ZS 371

STANDARD	BERU
12636	ZS 230
12637	ZS 234
12639	ZS 339
12640	ZS 298
12646	ZS 315
12649	ZS 356
12659	ZS 275
12660	ZS 278
12662	ZS 250
12678	ZS 344
12679	ZS 317
12680	ZS 318
12681	ZS 319
12683	ZS 261
12699	ZS 239
12700	ZS 029
12701	ZS 254
12702	ZS 255
12703	ZS 281
12705	ZS 345
12709	ZSE 011
12710	ZS 307
12715	ZS 365
12717	ZS 309
12720	ZSE 047
12722	ZS 358
12723	ZS 259
12726	ZSE 029
12727	ZSE 030
12728	ZSE 043
12731	ZS 256
12736	ZS 340
12737	ZS 320
12739	ZS 501
12745	ZS 361
12747	ZS 348
12749	ZSE 045
12750	ZS 349
12755	ZS 346
12756	ZS 351
12757	ZS 532
12758	ZS 324
12764	ZS 345
12766	ZS 347
12767	ZSE 046
12771	ZS 367
12772	ZS 387
12773	ZS 068
12778	ZSE 059
12791	ZSE 065
12798	ZSE 081
12801	ZS 437
12802	ZS 427
12810	ZSE 136
12818	ZSE 055
12832	ZSE 056
12835	ZS 355
12841	ZS 405
12856	ZSE 084
12864	ZSE 083
12867	ZSE 080
12877	ZSE 072
12884	ZS 095
12889	ZSE 140
12916	ZSE 001
12919	ZSE 003
15881	ZM 060
CP 018	ZS 437
CU 1118	ZS 437
CU 1225	ZS 532
CU 1300	ZS 436
CU 1374	ZS 095
CU 1385	ZSE 140
CU 1409	ZSE 132
CU 1489	ZSE 137
CU 1490	ZSE 126
CU 1509	ZS 395
DMB406	ZS 345
DMB408	ZS 354
DMB813	ZSE 047
IIS 001	ZSE 043
IIS 022	ZSE 072
IIS 024	ZSE 087
IIS 028	ZSE 071

STANDARD	BERU
IIS 029	ZSE 073
IIS 034	ZS 068
IIS 036	ZS 501
IIS 058	ZSE 083
IIS 080	ZS 365
IIS 160	ZS 437
IIS 174	ZSE 081
IIS 182	ZS 532
IIS 220	ZSE 136
IIS 241	ZS 405
IIS 243	ZS 355
IIS 247	ZSE 084
IIS 252	ZSE 080
IIS 270	ZS 095
IIS 289	ZSE 140
IIS 297	ZSE 086
IIS 300	ZSE 132
IIS 301	ZSE 133
IIS 339	ZS 436
IIS 349	ZS 410
IIS 366	ZSE 074
IIS 368	ZSE 076
IIS 369	ZSE 077
IIS 370	ZSE 079
IIS 372	ZSE 082
IIS 389	ZSE 126
IIS 390	ZSE 137
ISS 364	ZS 430
UF 103	ZS 356

STEIN	BERU
015754	WZ 09-2

STEVYR	BERU
721 185 0320	ZS 109
721 285 0320	ZS 109
9010757	ZS 106

SUBARU	BERU
49146--7401	ZM 046
82988-4110	ZS 106

SUZUKI	BERU
33090 0115A	ZS 280
33370641311	ZM 049
3337064B11	ZM 049
33400-62J00	ZSE 069
33400-62J00-000	ZSE 069
33400-83E00	ZSE 069
33400-83E00-000	ZSE 069
33400-83E10	ZSE 069
33400-83E10-000	ZSE 069
33410-64B10-000	ZS 274
33410-66D00	ZSE 136
33410-66D00-000	ZSE 136
33410-66D01	ZSE 136
33410-66D01-000	ZSE 136
33410-66D10	ZSE 136
33410-66D10-000	ZSE 136
33410-77E20	ZSE 072
33410-77E21	ZSE 072
33410-77E22	ZSE 072

SWAG	BERU
10 92 8548	ZSE 146
20 92 1109	ZS 014
20 93 6080	ZSE 144
20 93 6100	ZSE 143
20 93 6113	ZSE 145
26 92 2581	ZS 231
30 91 7194	ZSE 001
30 91 9032	ZSE 003
30 92 2038	ZSE 030
30 92 4500	ZSE 059
30 92 9859	ZSE 051
32 92 3258	ZSE 142
32 92 3260	ZSE 032
40 92 3187	ZS 259
40 92 3187	ZS 342

SWAG	BERU
40 92 7168	ZS 358
40 92 7522	ZS 359
40 92 8108	ZS 427
40 93 3666	ZSE 147
50 92 6869	ZS 350
60 92 1524	ZS 354
60 92 1525	ZS 345
60 92 1526	ZS 243
60 92 1527	ZS 242
60 92 1529	ZS 315
60 92 1666	ZS 052
60 92 2875	ZS 317
60 92 4435	ZS 347
62 92 4997	ZSE 047
70 91 9929	ZS 283
70 92 2697	ZS 029
81 92 8645	ZS 356
90 93 0261	ZSE 502

TALBOT	BERU
9150491280	ZM 001
9150589080	ZS 106
9150633880	ZM 001
A50633880	ZM 001

TESLA	BERU
CL003	ZSE 030
CL024	ZSE 065
CL031	ZSE 126
CL032	ZSE 137
CL221	ZS 427
CL323	ZS 095
CL403	ZS 387
CL515	ZSE 502
CL532	ZS 521
CL533	ZSE 136
CL548	ZS 434
CL600	ZS 437
CL621	ZSE 140
CL707	ZS 429
CL711	ZS 501

TOPRAN	BERU
109039	ZSE 030
109541	ZSE 043
111741	ZSE 142
206638	ZS 344
206640	ZS 259
206641	ZS 358
206642	ZSE 147
207466	ZS 427
207472	ZSE 151
302 104	ZS 422
302104	ZS 350
501401	ZS 382
721405	ZSE 047
721409	ZS 347

TOYOTA	BERU
78512-12310	ZM 058
89612-12310	ZM 058
89612-12320	ZM 058
89612-16080	ZM 058
89620-10090	ZM 057
89620-10120	ZM 057
89620-12290	ZM 058
89620-12310	ZM 058
89620-12320	ZM 058
89620-12340	ZM 057
89620-14210	ZM 059
89620-16070	ZM 057
89620-16080	ZM 058
89620-26080	ZM 058
89620-32020	ZM 059
90080-19017	ZS 449
90080-1901700	ZS 449
90919-02004	ZS 106
90919-02007	ZS 106
90919-02008	ZS 106
90919-02013	ZS 106

TOYOTA	BERU
90919-02014	ZS 106
90919-02015	ZS 106
90919-02016	ZS 106
90919-02017	ZS 106
90919-02019	ZS 106
90919-02020	ZS 106
90919-02026	ZS 106
90919-02027	ZS 106
90919-02030	ZS 106
90919-02031	ZS 106
90919-02043	ZS 106
90919-02094	ZS 109
90919-02164	ZS 356
90919-02215	ZS 430
L1305046	ZM 059

TRISCAN	BERU
8860 11008	ZS 435
8860 11012	ZSE 145
8860 11013	ZSE 143
8860 11014	ZSE 144
8860 12001	ZSE 148
8860 13017	ZS 449
8860 15014	ZS 309
8860 15015	ZS 361
8860 15016	ZS 428
8860 17008	ZS 088
8860 17009	ZS 501
8860 23010	ZSE 146
8860 24009	ZSE 147
8860 24011	ZS 358
8860 24012	ZS 259
8860 24016	ZSE 149
8860 28002	ZSE 047
8860 28004	ZSE 045
8860 28005	ZS 349
8860 29020	ZSE 043
8860 29023	ZSE 032
8860 29024	ZSE 030
8860 29025	ZSE 142
8860 43007	ZSE 502

VALEO	BERU
138419	ZSE 001
21597716-4	ZS 352
21603800-7	ZS 353
245000	ZS 110
245001	ZS 257
245010	ZS 106
245027	ZS 247
245038	ZS 258
245039	ZS 249
245040	ZS 232
245040	ZS 341
245041	ZS 231
245042	ZS 253
245043	ZS 252
245046	ZS 256
245047	ZS 106
245049	ZS 244
245052	ZS 248
245054	ZS 251
245057	ZS 344
245058	ZS 115
245062	ZS 252
245064	ZS 123
245066	ZS 254
245067	ZS 255
245068	ZS 250
245076	ZS 245
245077	ZS 246
245079	ZS 345
245080	ZS 296
245081	ZS 119
245085	ZS 346
245086	ZS 241
245088	ZS 343
245092	ZSE 001
245093	ZSE 002
245094	ZS 347
245095	ZSE 045
245096	ZSE 046

VALEO	BERU
245097	ZSE 047
245098	ZS 348
245099	ZS 349
245100	ZS 351
245101	ZS 352
245102	ZS 353
245103	ZSE 048
245104	ZS 052
245105	ZS 354
245106	ZS 242
245107	ZS 243
245108	ZS 342
245111	ZS 283
245116	ZS 320
245121	ZS 068
245139	ZS 350
245141	ZSE 030
245164	ZSE 142
245179	ZSE 026
245509	ZM 017
245513	ZM 008
245514	ZM 020
245515	ZM 005
245516	ZM 018
245517	ZM 047
245518	ZM 039
245519	ZM 002
245520	ZM 003
245521	ZM 012
245522	ZM 006
245523	ZM 007
245524	ZM 019
245525	ZM 026
245527	ZM 009
245531	ZM 013
245532	ZM 014
245534	ZM 004
245535	ZM 040
245536	ZM 015
245538	ZM 010
245539	ZM 022
245541	ZM 038
245547	ZM 032
245548	ZM 034
245550	ZM 023
245551	ZM 024
2526009	ZS 257
2526015	ZS 248
2526018	ZS 106
2526023	ZS 251
2526024	ZS 258
2526024A	ZS 258
2526030	ZS 244
2526034	ZS 250
2526035 A	ZS 231
2526039	ZS 231
2526048	ZS 251
2526049	ZS 253
2526050	ZS 252
2526051	ZS 254
2526052	ZS 255
2526059	ZS 256
2526062	ZS 252
2526086	ZS 343
2526110	ZS 245
2526111	ZS 246
2526116A	ZS 342
2528001	ZM 017
2528001A	ZM 017
2528008	ZM 001
2528008A	ZM 001
2595001	ZM 008
2595002	ZM 020
2595003	ZM 005
2595004	ZM 047
2595005	ZM 039
2595006	ZM 001
2595007	ZM 002
2595008	ZM 003
2595009	ZM 012
2595010	ZM 006
2595011	ZM 007
2595013	ZM 009
2595016	ZM 018

VALEO	BERU
2595017	ZM 017
2595020	ZM 013
2595021	ZM 014
2595023	ZM 004
2595024	ZM 040
2595025	ZM 015
2595027	ZM 010
2595030	ZM 038
2595038	ZM 032
2595039	ZM 034
2790	ZS 106
520019	ZS 110
520041	ZS 115
520064 A	ZS 251
73502602	ZM 017
B 6051	ZS 254
B 6052	ZS 255
B 6114	ZS 242
CD 303	ZS 106
CD 308	ZS 247
CD 309	ZS 106
CD 314	ZS 105
CD 315	ZS 106
CD 321	ZS 257
CD 323	ZS 106
CD 325	ZS 251
CD 326	ZS 258
CD 330	ZS 249
CD 331	ZS 232
CD 336	ZS 106
CD 338	ZS 253
CD 339	ZS 252
CD 440	ZS 344
CD 443	ZS 252
CD 604	ZM 003
CD 605	ZM 017
CD 856	ZM 001
CD 863	ZM 005
CD 866	ZM 039
CD 867	ZM 002
CD 868	ZM 003
CD 870	ZM 006
CD 871	ZM 007
CD 873	ZM 009
CD 880	ZM 004
CD 884	ZM 038
CD 885	ZM 008

VEMO	BERU
10-70-0012	ZSE 030
10-70-0013	ZSE 043
10-70-0014	ZSE 002
10-70-0044	ZSE 003
10-70-0045	ZS 016
10-70-0046	ZSE 029
10-70-0047	ZSE 040
10-70-0051	ZM 062
10-70-0058	ZSE 031
20-70-0011	ZS 014
20-70-0012	ZS 302
20-70-0013	ZS 324
20-70-0014	ZS 324
25-70-0001	ZS 350
25-70-0003	ZS 281
30-70-0002	ZM 004
30-70-0012	ZS 340
40-70-0011	ZS 253
40-70-0015	ZS 342
40-70-0016	ZS 259
V10-70-0010	ZSE 001
V10-70-0012	ZSE 030
V10-70-0013	ZSE 043
V10-70-0013-1	ZSE 043
V10-70-0044	ZSE 003
V10-70-0046	ZSE 029
V10-70-0054	ZSE 032
V10-70-0059	ZSE 059
V10-70-0060	ZSE 033
V10-70-0060	ZSE 142
V10-70-0062	ZSE 051
V10-70-0063	ZSE 044
V10-70-0064	ZSE 063
V10-70-0066	ZSE 065

VEMO	BERU
V10-70-0067	ZSE 062
V10-70-0068	ZSE 061
V10-70-0069	ZSE 004
V10-70-0098	ZSE 067
V10-70-0098	ZSE 126
V10-70-0099	ZSE 137
V20-70-0013	ZS 324
V20-70-0013	ZSE 143
V20-70-0014	ZS 324
V20-70-0017	ZSE 143
V24-70-0003	ZS 283
V24-70-0004	ZS 320
V24-70-0008	ZS 428
V25-70-0001	ZS 350
V25-70-0001	ZS 422
V25-70-0001-1	ZS 350
V25-70-0001-1	ZS 422
V25-70-0003	ZS 281
V25-70-0009	ZS 387
V26-70-0005	ZS 532
V30-70-0012	ZS 340
V30-70-0015	ZSE 146
V37-70-0032	ZS 395
V38-70-0002	ZS 376
V40-70-0010	ZSE 026
V40-70-0015	ZS 342
V40-70-0015-1	ZS 342
V40-70-0017	ZS 427
V40-70-0044	ZS 358
V40-70-0045	ZSE 147
V40-70-0047	ZSE 151
V40-70-0048	ZS 359
V40-70-0050	ZS 451
V40-70-0057	ZS 450
V40-70-0067	ZSE 150
V40-70-0069	ZSE 152
V40-70-0071	ZSE 149
V40-70-0072	ZSE 153
V42-70-0001	ZSE 047
V45-70-0001	ZS 036
V46-70-0001	ZS 052
V46-70-0002	ZS 354
V49-70-0003	ZS 501
V52-70-0014	ZS 536
V64-70-0009	ZSE 136
V70-70-0015	ZS 449
V95-70-0007	ZS 429

VOLKSWAGEN AG / AUDI	BERU
000 395 308 1	ZS 120
021 905 106	ZSE 004
021 905 106 A	ZSE 004
021 905 106 B	ZSE 013
021 905 106 C	ZSE 013
021 905 115	ZS 106
022 905 100 A	ZSE 063
022 905 100 B	ZSE 041
022 905 100 B	ZSE 044
022 905 100 D	ZSE 063
022 905 100 E	ZSE 041
022 905 100 E	ZSE 044
022 905 100 G	ZSE 063
022 905 100 H	ZSE 041
022 905 100 H	ZSE 044
022 905 100 K	ZSE 063
022 905 100 L	ZSE 041
022 905 100 L	ZSE 044
022 905 100 N	ZSE 063
022 905 100 P	ZSE 041
022 905 100 P	ZSE 044
022 905 100 S	ZSE 041
022 905 100 S	ZSE 044
022 905 100 T	ZSE 041
022 905 100 T	ZSE 044
022 905 115	ZS 106
022 905 115 B	ZS 106
022 905 115 C	ZS 106
022 905 715	ZSE 041
022 905 715	ZSE 044
022 905 715 A	ZSE 041
022 905 715 B	ZSE 044
022 905 715 C	ZSE 063
028 905 115 A	ZS 109

VOLKSWAGEN AG / AUDI	BERU
028 905 115 B	ZS 109
032 905 106	ZSE 003
032 905 106 B	ZSE 003
032 905 106 D	ZSE 003
032 905 106 E	ZSE 003
034 905 101	ZS 043
034 905 101	ZS 043
034 905 105	ZS 043
034 905 105	ZS 043
035 905 105 A	ZS 120
036 905 100 A	ZSE 030
036 905 100 B	ZSE 030
036 905 100 C	ZSE 030
036 905 100 D	ZSE 030
036 905 715	ZSE 030
036 905 715 A	ZSE 030
036 905 715 C	ZSE 030
036 905 715 E	ZSE 030
036 905 715 F	ZSE 030
036 905 715 G	ZSE 030
03D 905 115	ZSE 059
03D 905 115 A	ZSE 059
03D 905 115 B	ZSE 059
03D 905 115 C	ZSE 059
03D 905 115 D	ZSE 059
03D 905 115 E	ZSE 059
03D 905 115 F	ZSE 059
03D 905 115 G	ZSE 059
03D 905 715 A	ZSE 059
043 905 115 A	ZS 106
043 905 115 C	ZS 106
047 905 104	ZSE 039
047 905 104 A	ZSE 040
047 905 104 B	ZSE 040
048 905 1051	ZS 234
04C 905 110 B	ZSE 067
04C 905 110 D	ZSE 067
04E 905 110 A	ZSE 126
04E 905 110 B	ZSE 126
052 905 105	ZS 106
058 905 101	ZS 016
059 905 105	ZS 115
059 905 105 B	ZS 115
066 905 100	ZSE 065
066 905 100 B	ZSE 065
066 905 100 C	ZSE 065
066 905 100 D	ZSE 065
066 905 100 G	ZSE 065
06A 905 097	ZSE 029
06A 905 104	ZSE 029
06A 905 115	ZSE 043
06A 905 115 A	ZSE 043
06A 905 115 B	ZSE 043
06A 905 115 C	ZSE 043
06A 905 115 D	ZSE 043
06B 905 115	ZSE 009
06B 905 115 B	ZSE 009
06B 905 115 D	ZSE 043
06B 905 115 E	ZSE 009
06B 905 115 G	ZSE 043
06B 905 115 H	ZSE 043
06B 905 115 J	ZSE 043
06B 905 115 L	ZSE 043
06B 905 115 M	ZSE 043
06B 905 115 N	ZSE 043
06B 905 115 P	ZSE 043
06B 905 115 Q	ZSE 043
06B 905 115 R	ZSE 043
06B 905 115 S	ZSE 043
06C 905 115 A	ZSE 051
06C 905 115 B	ZSE 051
06C 905 115 C	ZSE 043
06C 905 115 D	ZSE 051
06C 905 115 E	ZSE 051
06C 905 115 F	ZSE 051
06C 905 115 G	ZSE 051
06C 905 115 H	ZSE 051
06C 905 115 K	ZSE 051
06C 905 115 L	ZSE 051
06C 905 115 M	ZSE 051
06D 905 115	ZSE 032
06D 905 115 A	ZSE 032
06D 905 115 C	ZSE 032
06D 905 115 D	ZSE 032

VOLKSWAGEN AG / AUDI	BERU
06D 905 115 F	ZSE 032
06D 905 115 G	ZSE 032
06D 905 115 J	ZSE 032
06D 905 115 K	ZSE 032
06E 905 115	ZSE 032
06E 905 115 A	ZSE 032
06E 905 115 B	ZSE 032
06E 905 115 C	ZSE 032
06E 905 115 D	ZSE 032
06E 905 115 E	ZSE 032
06F 905 115	ZSE 033
06F 905 115 A	ZSE 033
06F 905 115 B	ZSE 033
06F 905 115 C	ZSE 033
06F 905 115 D	ZSE 033
06F 905 115 E	ZSE 033
06F 905 115 F	ZSE 033
06H 905 110 D	ZSE 137
06H 905 110 E	ZSE 137
06H 905 115 A	ZSE 142
06H 905 115 B	ZSE 142
06J 905 110 B	ZSE 068
06J 905 110 C	ZSE 068
06J 905 110 D	ZSE 068
06J 905 110 E	ZSE 068
071 905 106	ZS 037
077 905 104	ZS 017
077 905 115 AA	ZSE 062
077 905 115 B	ZSE 061
077 905 115 C	ZSE 061
077 905 115 E	ZSE 061
077 905 115 F	ZSE 061
077 905 115 G	ZSE 062
077 905 115 H	ZSE 061
077 905 115 J	ZSE 062
077 905 115 K	ZSE 061
077 905 115 M	ZSE 062
077 905 115 P	ZSE 061
077 905 115 Q	ZSE 061
077 905 115 R	ZSE 062
077 905 115 S	ZSE 062
077 905 115 T	ZSE 061
078 905 101 A	ZSE 007
078 905 101 C	ZSE 008
07C 905 115 C	ZSE 031
07C 905 115 D	ZSE 031
07C 905 115 E	ZSE 031
07C 905 115 F	ZSE 031
07C 905 115 H	ZSE 031
07C 905 115 J	ZSE 031
07C 905 715	ZSE 031
07C 905 715 A	ZSE 031
07K 905 715	ZSE 033
07K 905 715 A	ZSE 033
07K 905 715 B	ZSE 033
07K 905 715 C	ZSE 033
07K 905 715 D	ZSE 033
07K 905 715 E	ZSE 033
07K 905 715 F	ZSE 033
07P 905 715	ZSE 138
111 905 105 H	ZS 106
111 905 115	ZS 106
111 905 115 B	ZS 106
112 905 115	ZS 106
112 905 115 B	ZS 106
115 915 080	ZM 060
122 905 115 B	ZS 106
171 905 115 A	ZS 115
191 905 115	ZS 124
191 905 115 A	ZS 123
191 905 351 A	ZM 012
191 905 351 B	ZM 012
191 905 351 C	ZM 012
211 905 115 D	ZS 124
211 905 351	ZM 002
211 905 351 A	ZM 002
211 905 351 B	ZM 002
211 905 351 D	ZM 002
211 905 351 E	ZM 002
221 100 019	ZS 106
251 905 115	ZS 106
310 880 01	ZSE 004
311 905 115 B	ZS 106
311 905 115 C	ZS 106

VOLKSWAGEN AG / AUDI	BERU
330 905 115 A	ZS 280
357 905 104	ZSE 001
376 815 090 100 00	ZS 106
377 905 105 D	ZS 314
440 905 105	ZM 031
443 905 105 B	ZM 031
443 905 105 C	ZM 031
4A0 905 351	ZM 027
4A0 905 351 A	ZM 063
4D0 905 351	ZM 062
4D0 997 351	ZM 062
535 905 115	ZM 036
6N0 905 104	ZSE 001
701 905 104	ZSE 002
701 905 104 A	ZSE 002
867 905 104	ZSE 001
867 905 104 A	ZSE 001
867 905 105 A	ZSE 002
867 905 351	ZM 014
867 905 352	ZM 013
892 031 071	ZS 106
892 031 071 000 00	ZS 106
8D0 905 105	ZSE 006
8D0 905 351	ZM 028

VOLVO	BERU
9438230	ZS 400
9438231	ZS 122

ZASTAVA	BERU
46627428	ZM 001

VOLVO	BERU
1207458	ZS 115
1219189	ZS 106
1275174	ZSE 037
1275602	ZS 429
1298429	ZM 001
1317809	ZM 002
1317810	ZS 120
1317815	ZS 120
1317820	ZM 001
1332584	ZM 015
1346071	ZS 119
1367777	ZM 036
1389939	ZM 002
240523	ZS 106
241086	ZS 115
241609	ZS 106
241611	ZS 106
241688	ZS 106
241688-1	ZS 106
269207	ZS 400
269208	WZ 04-2
269209	WZ 04-2
285230	ZM 039
2867906	ZS 119
30713416	ZSE 019
30713417	ZSE 055
30731416	ZS 387
30731419	ZS 387
30735759	ZS 350
316447	ZS 106
3287677	ZS 251
3287677-3	ZS 251
345061	ZS 106
3501921	ZM 040
3501921-5	ZM 040
35254	ZS 106
464324	ZS 400
464325	WZ 04-2
464326	WZ 04-2
7035254	ZS 106
70863020	ZS 254
70863020-7	ZS 245
70863021	ZS 255
70863021-5	ZS 246
76834	ZS 105
826490	ZS 115
834461	ZS 106
834462	ZS 106
841931	ZS 115
8522328	ZS 106
8573834	ZS 121
8677837	ZSE 055
870700	ZS 106
870909	ZS 115
870943	ZS 115
9125601	ZSE 019
9438228	ZS 120



- |     |  |     |   |
|-----|--|-----|---|
| 14  | Transistor- Zündanlage   | 14  | Transistorized ignition system  |
| 19  | Hitzeschutzschild für Zündspule  | 19  | Heat shield   |
| 20  | Solange Vorrat reicht  | 20  | while stocks last   |
| 42  | Rot  | 42  | red   |
| 43  | Grau   | 43  | grey  |
| 51  | Gasmotoren   | 51  | Gas engines   |
| 52  | Gabelstapler   | 52  | Fork-lift trucks  |
| 53  | Gelbes Etikett   | 53  | Yellow label  |
| 54  | Grünes Etikett   | 54  | Green label   |
| 55  | Zündspule für Transistor- Zündanlage   | 55  | Ignition coil for transistor ignition   |
| 57  | Graues Etikett   | 57  | Grey label  |
| 60  | Doppelzündung  | 60  | twin-plug ignition  |
| 61  | Nur in Verbindung mit Zündkerze NGK MAR10-A-J  | 61  | only in conjunction with spark plug NGK MAR10-A-J   |
| 62  | Pumpe (Feuerwehr)  | 62  | Pump (fire service)   |
| 63  | Ersatz   | 63  | Replacement   |
| 64  | Zündspulenkopf   | 64  | Ignition coil head  |
| 65  | Kabellänge   | 65  | Cable length  |
| 66  | 2 Stück pro Zylinder   | 66  | 2 x per cylinder  |
| 105 | Neu im Katalog   | 105 | New in the catalog  |
| 106 | Überblick auf Type und Bestellnummer   | 106 | Overview of type and order number   |
| 109 | Umcodierungseinrichtung original Ausführung Bestell-Nr (OE) Handel Bestell-Nr. (AM)  | 109 | Re-coding original equipment order no. (OE) → trade order no. (AM)  |
| 112 | Querverweisliste   | 112 | Cross reference list  |
| 117 | Steckergehäuse rot   | 117 | Plug housing, red   |
| 118 | Steckergehäuse grau  | 118 | Plug housing, grey  |
| 119 | Steckergehäuse braun   | 119 | Plug housing, brown   |
| 120 | Steckergehäuse schwarz   | 120 | Plug housing, black   |
| 121 | Steckergehäuse weiss   | 121 | Plug housing, white   |
| 122 | 2 x Zündspulen ZS 234 erforderlich für 8 Zylinder- Motoren und Alfa Romeo Twin Spark (4 Zylinder)  | 122 | 2 x coils ZS 234 required for 8-cyl. engines and Alfa Romeo Twin Spark (4 cyl.)   |
| 123 | Mit Endstufe   | 123 | with output stage   |
| 125 | Für 1,2- Zylindermotoren   | 125 | for 1, 2-cyl. Engines   |
| 126 | Montagehalter für Zündspulen   | 126 | Mounting bracket  |
| 127 | Ohne Startspannungsanhebung  | 127 | without start boosting  |
| 128 | Mit Startspannungsanhebung   | 128 | with start boosting   |
| 129 | Startspannungsanhebung möglich   | 129 | Start boosting possible   |
| 130 | Zylinder   | 130 | Cylinder  |
| 133 | Standart Spule, schwarz  | 133 | Standard coil, black  |
| 134 | Hochleistungs- Zündspule, blau   | 134 | High-performance coil, blue   |
| 135 | Resistor- Hochleistungs- Zündspule, orange   | 135 | Resistor high-performance coil, orange  |
| 136 | Silber   | 136 | silver  |
| 137 | Zündspule für Transistorzündung, blau  | 137 | Coil for transistorized ignition system, blue   |
| 138 | Hochleistungs- Zündspule, schwarz  | 138 | High-performance coil, black  |
| 162 | Nach DIN 72531, mit internationaler Befestigungsschelle  | 162 | DIN 72531 with international fastening clamp  |
| 170 | Anschlussart   | 170 | Connection  |
| 174 | Fahrzeuge mit 2,3,4,5,6,8 -Zylinder- Motor, Zündanlage ohne Vorwiderstand  | 174 | Vehicles with 2, 3, 4, 5, 6, 8-cylinder engines, ignition system without ballast resistor only                                      |
| 176 | Fahrzeuge mit 4,5,6,8 -Zylinder- Motor, 1,8 Ω Widerstand WZ 18-2/ 0 110 520 001 vorschalten oder Widerstandsleistung 1,8 Ω verwenden (Serie oder nachrüsten) | 176 | Vehicles with 4, 5, 6, 8-cylinder engines, connect 1.8 Ω resistor in series or use 1.8 Ω resistance lead (production or retrofit)   |
| 177 | Fahrzeuge mit 4,5,6,8 -Zylinder- Motor, 1,8 Ω Vorschaltwiderstand WZ 18-2/ 0 110 520 001 (beigepackt) zur Nachrüstung, dadurch Kaltstartverbesserung         | 177 | Vehicles with 4, 5, 6, 8-cylinder engine, with 1.8 Ω ballast resistor in series (included) for retrofitting, improves cold starting |
| 180 | Zündspule für 1 und 2 Zyl. Motoren ohne Befestigungsklammer  | 180 | Ignition coil for 1 and 2 cyl. engines without fastening clamp.   |
| 181 | Fahrzeuge mit 4,6 -Zylinder- Motor, 0,9 Ω Widerstand WZ 09 -2/ 0 110 510 008 vorschalten oder Widerstandsleistung 0,9 Ω verwenden (Serie oder nachrüsten)    | 181 | Vehicles with 4, 6-cylinder engine, connect 0.9 Ω resistor in series or use 0.9 Ω resistor lead (production or retrofit)            |
| 182 | Für 2- Zylinder Motor u. 6- Volt- Batterie (2 Zündspulen primärseitig hintereinander geschaltet)   | 182 | For 2 cyl. engines with 6 volts battery (2 ignition coils placed in series on the primary)  |
| 194 | Anschlussleitung   | 194 | Connecting cable  |
| 198 | Herstellerbezogene Sortimente  | 198 | Product ranges according to manufacturer  |
| 201 | Für elektronische Zündanlage   | 201 | for electronic ignition system  |
| 202 | Am Fahrzeug ermitteln  | 202 | check correct ignition coil on vehicle  |
| 207 | Induktiv   | 207 | inductive   |
| 208 | Hallgeber  | 208 | Hall  |
| 210 | In Vorbereitung  | 210 | in preparation  |
| 238 | Umschlüsselung Fremtteile BERU   | 238 | Recoding bought-in parts → BERU   |
| 279 | Entstörstecker für Einzelzündspulen  | 279 | Replaced  |
| 280 | Anbau links  | 280 | Interference suppression connector for single coils   |
| 281 | Anbau rechts   | 281 | Extension on left   |
| 282 | Nur paarweise tauschen   | 282 | Extension on right  |
|     |  |     | replace ZS 052 in pairs only  |

- |     |   |     |   |
|-----|---|-----|---|
| 14  | Allumage transistorisé  | 14  | Transistorontsteking  |
| 19  | Protection thermique  | 19  | Hittebeschermingsplaat  |
| 20  | jusqu'à épuisement du stock   | 20  | zolang de voorraad strekt   |
| 42  | rouge   | 42  | rood  |
| 43  | grise   | 43  | grijs   |
| 51  | Moteurs à gaz   | 51  | Gasmotor  |
| 52  | Chariot élévateur à fourche   | 52  | Vorkheftruck  |
| 53  | Etiquette jaune   | 53  | Etiket geel   |
| 54  | Etiquette verte   | 54  | Etiket groen  |
| 55  | Bobine d'allumage pour allumage transistorisé   | 55  | Bobine voor transistorontsteking  |
| 57  | Etiquette grise   | 57  | Etiket grijs  |
| 60  | double allumage   | 60  | Dubbele ontsteking  |
| 61  | uniquement en combinaison avec la bougie d'allumage NGK MAR10-A-J   | 61  | alleen in combinatie met bougie NGK MAR10-A-J   |
| 62  | Pompe (pompiers)  | 62  | Pomp (brandweer)  |
| 63  | Remplacement  | 63  | Vervanging  |
| 64  | Tête de bobine d'allumage   | 64  | Bobinekop   |
| 65  | Longueur de câble   | 65  | Kabellengte   |
| 66  | 2 par cylindre  | 66  | 2 stuks per cilinder  |
| 105 | Nouveau dans le catalogue   | 105 | Nieuw in de catalogus   |
| 106 | Vue d'ensemble par type et référence  | 106 | Overzicht naar type en bestelnummer   |
| 109 | Décodage référence première-monte (OE) → référence commerce (AM)  | 109 | Omcodering eerste uitrusting bestelnummer (OE) → handelsbestelnummer (AM)   |
| 112 | Types de remplacement   | 112 | Reservetypes  |
| 117 | boîtier de prise, roux  | 117 | Stekkerbehuizing rood   |
| 118 | boîtier de prise, gris  | 118 | Stekkerbehuizing grijs  |
| 119 | boîtier de prise, marron  | 119 | Stekkerbehuizing bruin  |
| 120 | boîtier de prise, noir  | 120 | Stekkerbehuizing zwart  |
| 121 | boîtier de prise, blanc   | 121 | Stekkerbehuizing wit  |
| 122 | 2 x bobines d'allumage ZS 234 requises pour des moteurs à 8 cylindres et Alfa Romeo Twin Spark (4 cyl.)           | 122 | 2 x bobines ZS 234 noodzakelijk voor 8 cilindermotoren en Alfa Romeo Twin Spark (4 cilinders)   |
| 123 | avec étage final  | 123 | met eindtrap  |
| 125 | pour des moteurs à 1, 2 cylindres   | 125 | voor 1, 2-cilindermotoren   |
| 126 | support de montage  | 126 | Montagehouder voor bobines  |
| 127 | sans élévation de la tension de démarrage   | 127 | zonder verhoging van de startspanning   |
| 128 | avec élévation de la tension de démarrage   | 128 | met verhoging van de startspanning  |
| 129 | possibilité d'élévation de la tension de démarrage  | 129 | Verhoging van de startspanning mogelijk   |
| 130 | cylindre  | 130 | Cilinder  |
| 133 | bobine d'allumage standard, noire   | 133 | Bobine (zwart)  |
| 134 | bobine d'allumage de grande puissance, bleue  | 134 | Krachtige bobine, blauw   |
| 135 | bobine d'allumage de grande puissance à résistance, orange  | 135 | Krachtige resistor bobine, oranje   |
| 136 | couleur grise   | 136 | zilver  |
| 137 | bobine d'allumage pour allumage à transistors, bleue  | 137 | Bobine voor transistorontsteking, blauw   |
| 138 | bobine d'allumage de grande puissance, noire  | 138 | Krachtige bobine, zwart   |
| 162 | Conformément à DIN 72531 avec bride de fixation internationale  | 162 | Conform DIN 72531 met internationale bevestigingsklem   |
| 170 | Connexion   | 170 | Aansluitingen   |
| 174 | Pour des moteurs à 2, 3, 4, 5, 6, 8 cyl., syst. d'allumage sans résistance  | 174 | Voertuigen met 2, 3, 4, 5, 6, 8-cilindermotor, ontstekingsinstallatie zonder voorweerstand  |
| 176 | Pour véhicules 4, 5, 6, 8 cyl. avec résistance 1,8 Ω montée en série ou intégrée au câblage (en série ou options) | 176 | Voertuigen met 4, 5, 6, 8-cilindermotor, 1,8 W weerstand WZ 18-2/0 110 520 001 voorschakelen of weerstandsleiding 1,8 W gebruiken (standaard of montage achteraf) |
| 177 | Pour véhicules 4, 5, 6, 8 cyl. avec résistance 1,8 Ω montée en série (incluse) pour meilleur démarrage à froid    | 177 | Voertuigen met 4, 5, 6, 8-cilindermotor, 1,8 W voorschakelweerstand WZ 18-2/0 110 520 001 (bijgesloten) zonder montage achteraf, daardoor verbetering             |
| 180 | Bobines d'allumage pour des moteurs à 1 et 2 cyl. sans bride de fixation.   | 180 | zonder bevestigingsklem   |
| 181 | Pour véhicules de 4, 6 cyl. avec résistance 0,9 Ω montée en série ou intégrée au câblage (en série ou options)    | 181 | Voertuigen met 4, 6-cilindermotor, 0,9 W weerstand WZ 09-2/0 110 510 008 voorschakelen of weerstandsleiding 0,9 W gebruiken (standaard of montage achteraf)       |
| 182 | Pour des moteurs à 2 cyl. avec batterie de 6 volts (2 bobine installées en série sur le coté primaire)            | 182 | voor 2-cilindermotor en 6-Volt batterij (2 bobines aan primaire zijde achter elkaar geschakeld)   |
| 194 | Ligne de connexion  | 194 | Aansluitleiding   |
| 198 | Assortiments en fonction du fabricant   | 198 | Fabrikantgerelateerde sortimenten   |
| 201 | pour système d'allumage électronique  | 201 | voor elektronische ontstekingsinstallatie   |
| 202 | déterminer la bobine d'allumage appropriée sur le véhicule  | 202 | op voertuig. Bepalen  |
| 207 | inductif  | 207 | inductief   |
| 208 | Hall  | 208 | Hall  |
| 210 | en préparation  | 210 | in voorbereiding  |
| 238 | Décryptage pièces d'autres marques → BERU   | 238 | Omcodering externe delen → BERU   |
| 263 | Remplacé  | 263 | vervangen   |
| 279 | Embout d'antiparasitage pour bobines d'allumage unitaires   | 279 | Ontstoriingsstekker voor afzonderlijke bobines  |
| 280 | Montage à gauche  | 280 | Aanbouw links   |
| 281 | Montage à droite  | 281 | Aanbouw rechts  |
| 282 | remplacer ZS 052 uniquement par paires  | 282 | ZS 052 alleen paarsgewijze vervangen  |



- |     |   |     |  |
|-----|---|-----|--|
| 14  | Instalación de encendido transistorizado  | 14  | Accensione a transistor  |
| 19  | Protección térmica  | 19  | Scudo termico  |
| 20  | Hasta que se agoten las existencias   | 20  | fino ad esaurimento scorte   |
| 42  | rojo  | 42  | rosso  |
| 43  | gris  | 43  | grigia   |
| 51  | Motores a gas   | 51  | Motori a gas   |
| 52  | Carretilla de horquilla elevadora   | 52  | Carrelli elevatori   |
| 53  | Etiqueta amarilla   | 53  | Etichetta gialla   |
| 54  | Etiqueta verde  | 54  | Etichetta verde  |
| 55  | Bobina de encendido para encendido transistorizado  | 55  | Bobina di accensione per accensione a transistor   |
| 57  | Etiqueta gris   | 57  | Etichetta grigia   |
| 60  | Encendido doble   | 60  | Doppia accensione  |
| 61  | solo en combinación con la bujía de encendido NGK MAR10-A-J   | 61  | solo in abbinamento alla candela d'accensione NGK MAR10-A-J  |
| 62  | Bomba (bomberos)  | 62  | Pompa (pompieri)   |
| 63  | Repuesto  | 63  | Ricambio   |
| 64  | Cabeza de bobina de encendido   | 64  | Testa della bobina   |
| 65  | Longitud de cable   | 65  | Lunghezza cavo   |
| 66  | 2 piezas por cilindro   | 66  | 2 pz. per cilindro   |
| 105 | Nuevo en el catálogo  | 105 | Novità del catalogo  |
| 106 | Resumen por tipo y número de pedido   | 106 | Panoramica secondo tipo e numero di ordinazione  |
| 109 | Conversión núm. ped. Equipo original (OE) → Núm. pedido comercial (AM)  | 109 | Chiave di decodificazione n° d'ordine primo montaggio (OE) → n° d'ordine distributore (AM)   |
| 112 | Tipos de recambio   | 112 | Tipi di sostituzione   |
| 117 | Cuerpo de enchufe rojo  | 117 | alloggiamento della presa rosso  |
| 118 | Cuerpo de enchufe gris  | 118 | alloggiamento della presa grigio   |
| 119 | Cuerpo de enchufe marrón  | 119 | alloggiamento della presa marrone  |
| 120 | Cuerpo de enchufe negro   | 120 | alloggiamento della presa nero   |
| 121 | Cuerpo de enchufe blanco  | 121 | alloggiamento della presa bianco   |
| 122 | 2 x bobinas de encendido ZS 234 necesarias para motores de 8 cilindros y Alfa Romeo Twin Spark (4 cil.)   | 122 | 2 bobine d'accensione ZS 234 richieste per motori a 8 cilindri e Alfa Romeo Twin Spark (4 cil.)  |
| 123 | con etapa final   | 123 | con finale   |
| 125 | para motores de 1, 2 cilindros  | 125 | per motori a 1, 2 cilindri   |
| 126 | Soporte para montaje  | 126 | supporto di montaggio  |
| 127 | sin elevación de la tensión de arranque   | 127 | senza incremento della tensione d'avviamento   |
| 128 | con elevación de la tensión de arranque   | 128 | con incremento della tensione d'avviamento   |
| 129 | Elevación de la tensión de arranque es posible  | 129 | possibilità di incremento della tensione d'avviamento  |
| 130 | Cilindro  | 130 | cilindro   |
| 133 | Bobina de encendido estándar, negro   | 133 | bobina d'accensione standard, nera   |
| 134 | Bobina de encendido de alto rendimiento, azul   | 134 | bobina d'accensione ad alto rendimento, blu  |
| 135 | Bobina de encendido de alto rendimiento de resistor, naranja  | 135 | bobina d'accensione ad alto rendimento con resistore, arancione  |
| 136 | plata   | 136 | argento  |
| 137 | Bobina de encendido para encendido transistorizado, azul  | 137 | bobina d'accensione a transistor, blu  |
| 138 | Bobina de encendido de alto rendimiento, negro  | 138 | bobina d'accensione ad alto rendimento, nera   |
| 162 | Conforme a DIN 72531 con brida de fijación internacional  | 162 | Secondo DIN 72 531 con brida di fissaggio internazionale   |
| 170 | Conexión  | 170 | collegamento   |
| 174 | Vehículos con motores de 2, 3, 4, 5, 6, 8 cilindros, sistema de encendido sin resistor protector  | 174 | Per veicoli con motore a 2, 3, 4, 5, 6, 8 cilindri, impianto di accensione senza resistenza  |
| 176 | Vehículos con motores de 4, 5, 6, 8 cilindros, intercalar resistor de 1,8 Ω o bien utilizar conductor resistente de 1,8 Ω (equipamiento de serie o ulterior)                  | 176 | Per veicoli con motore a 4, 5, 6, 8 cilindri, predisporre davanti resistenza da 1,8 Ω o utilizzare un cavo resistenza da 1,8 Ω (di serie o da montaggio) |
| 177 | Vehículos con motores de 4, 5, 6, 8 cilindros, con resistor reductor de 1,8 Ω (incluido en el paquete) como equipamiento ulterior, de este modo se mejora el arranque en frío | 177 | Per vehículos con motore a 4, 5, 6, 8 cilindri con preresistencia da 1,8 Ω (fornita) per il montaggio, miglioramento della partenza a freddo             |
| 180 | Bobina de encendido para motores de 1 y 2 cilindros sin brida de fijación.  | 180 | Bobina di accensione per motori ad 1 e 2 cilindri senza brida di fissaggio.  |
| 181 | Vehículos con motores de 4, 6 cilindros, intercalar resistor de 0,9 Ω o bien utilizar conductor resistente de 0,9 Ω (equipamiento de serie o ulterior)                        | 181 | Per veicoli con motore a 4, 6 cilindri, predisporre davanti resistenza da 0,9 Ω o utilizzare un cavo resistenza da 0,9 Ω (di serie o da montaggio)       |
| 182 | Para motores de 2 cilindros con batería de 6 voltios (2 bobinas de encendido conmutadas en serie en la parte primaria)  | 182 | Per motori a 2 cilindri con batería da 6 Volt (2 bobine di accensione sul lato primario collegate in serie)  |
| 194 | Cables de conexión  | 194 | Cavo di collegamento   |
| 198 | Surtidos clasificados por marcas  | 198 | Assortimenti riferiti ai produttori  |
| 201 | para instalación de encendido electrónica   | 201 | per impianto d'accensione elettronico  |
| 202 | comprobar la bobina de encendido correcta en el vehículo  | 202 | rilevare la corretta bobina d'accensione nel veicolo   |
| 207 | inductivo   | 207 | induttivo  |
| 208 | Hall  | 208 | Hall   |
| 210 | En preparación  | 210 | in preparazione  |
| 238 | Cambio de clave, piezas ajenas → BERU   | 238 | Identificazione in chiave di componenti di altri produttori → BERU   |
| 263 | sustituido  | 263 | sostituito   |
| 279 | Enchufe antiparasitario para bobinas de encendido   | 279 | Spinotto antiinterferenze per bobine singole   |
| 280 | Montaje a la izquierda  | 280 | Montaggio sinistro   |
| 281 | Montaje a la derecha  | 281 | Montaggio destro   |
| 282 | Cambie ZS 052 sólo por pares  | 282 | Sostituire ZS 052 solo in coppia   |



- 14 Транзисторная система зажигания  
19 Теплозащитный щиток  
20 пока хватит складских запасов  
42 красного цвета  
43 серый цвета  
51 Газовый двигатель  
52 Вилочный погрузчик  
53 Этикетка желтого цвета  
54 Этикетка зеленого цвета  
55 Катушка зажигания для транзисторной системы зажигания  
57 Этикетка серого цвета  
60 двойное зажигание  
61 только в сочетании со свечой зажигания NGK MAR10-A-J  
62 Насос (пожарный)  
63 Запчасть  
64 Головка катушки зажигания  
65 Длина кабеля  
66 2 шт. на цилиндр  
105 Новинка в каталоге  
106 Перечень по типу и номеру заказа  
109 Перекодирование № заказа завода-изготовителя (OE)  
→ № заказа в торговом предприятии (AM)  
112 Запасные типы  
117 Корпус штекера красного цвета  
118 Корпус штекера серого цвета  
119 Корпус штекера коричневого цвета  
120 Корпус штекера черного цвета  
121 Корпус штекера белого цвета  
122 2 катушки зажигания ZS 234 требуются для 8-цилиндровых двигателей и Alfa Romeo Twin Spark (4 цилиндра)  
123 с выходным каскадом  
125 для 1- и 2-цилиндровых двигателей  
126 Монтажный кронштейн для катушек зажигания  
127 без шунтирования добавочного резистора в системе зажигания при пуске  
128 с шунтированием добавочного резистора в системе зажигания при пуске  
129 Возможно шунтирование добавочного резистора в системе зажигания при пуске  
130 Цилиндр  
133 Катушка зажигания (черного цвета)  
134 Высокомощная катушка зажигания, синего цвета  
135 Высокомощная резисторная катушка зажигания, оранжевого цвета  
136 серебристого цвета  
137 Катушка транзисторной системы зажигания, синего цвета  
138 Высокомощная катушка зажигания, черного цвета  
162 Согласно DIN 72531, с крепежным хомутом международного типа  
170 Подключения  
174 Автомобили с 2-, 3-, 4-, 5-, 6-, 8-цил. двигателем, система зажигания без добавочного резистора  
176 Автомобили с 4-, 5-, 6-, 8-цил. двигателем, подключить добавочный резистор 1,8 Ом WZ 18-2/0 110 520 001 или использовать кабель резистора 1,8 Ом (серийное исполнение или дооборудование)  
177 Автомобили с 4-, 5-, 6-, 8-цил. двигателем, добавочный резистор 1,8 Ом WZ 18-2/0 110 520 001 (в отдельной упаковке) для дооборудования, улучшающий запуск холодного двигателя  
180 без крепежного хомута  
181 Автомобили с 4-, 6-цил. двигателем, подключить добавочный резистор 0,9 Ом WZ 09-2/0 110 510 008 или использовать кабель резистора 0,9 Ом (серийное исполнение или дооборудование)  
182 для 2-цил. двигателя и батареи на 6 В (2 катушки зажигания подключены последовательно в первичной цепи)  
194 Соединительный провод  
198 Ассортимент в соответствии с изготовителем  
201 для электронной системы зажигания  
202 на автомобиле. Определить  
207 индуктивный  
208 Холла  
210 в процессе подготовки  
238 Перекодировка деталей других изготовителей → BERU  
263 заменено  
279 Экранированный наконечник для отдельных катушек зажигания  
280 Монтаж слева  
281 Монтаж справа  
282 ZS 052 заменять только попарно
- 14 Tranzystorowy układ zapłonowy  
19 Blacha termiczna  
20 do wyczerpania zapasów  
42 czerwony  
43 szara  
51 Silnik gazowy  
52 Wózek widłowy  
53 Etykieta żółta  
54 Etykieta zielona  
55 Cewka zapłonowa do tranzystorowego układu zapłonowego  
57 Etykieta szara  
60 Podwójny zapłon  
61 tylko w połączeniu ze świecą zapłonową NGK MAR10-A-J  
62 Pompa (pożarnicza)  
63 Zamiennik  
64 Głowica cewki zapłonowej  
65 Długość przewodu  
66 2 szt. na cylinder  
105 Nowość w katalogu  
106 Przegląd wg typu i numeru katalogowego  
109 Przełożenie nr katalogowego części oryginalnej (OE) → nr katalogowy handlowy (AM)  
112 Zamienniki  
117 Obudowa wtyczki czerwona  
118 Obudowa wtyczki szara  
119 Obudowa wtyczki brązowa  
120 Obudowa wtyczki czarna  
121 Obudowa wtyczki biała  
122 2 x cewka zapłonowa ZS 234 do silników 8-cylindrowych oraz Alfa Romeo Twin Spark (4-cylindrowy)  
123 ze wzmacniaczem mocy  
125 do silników 1- i 2-cylindrowych  
126 Uchwyt montażowy do cewek zapłonowych  
127 bez podnoszenia napięcia rozruchowego  
128 z podniesieniem napięcia rozruchowego  
129 Możliwe podniesienie napięcia rozruchowego  
130 Cylinder  
133 Cewka zapłonowa (czarna)  
134 Cewka zapłonowa wysokiej mocy, niebieska  
135 Cewka zapłonowa wysokiej mocy z rezystorem, pomarańczowa  
136 srebrny  
137 Cewka zapłonowa do zapłonu tranzystorowego, niebieska  
138 Cewka zapłonowa wysokiej mocy, czarna  
162 Wg DIN 72531, z międzynarodową opaską mocującą  
170 Złącza  
174 Pojazdy z silnikiem 2-, 3-, 4-, 5-, 6- i 8-cylindrowym, układ zapłonowy bez rezystora wstępnego  
176 Pojazdy z silnikiem 4-, 5-, 6- i 8-cylindrowym, podłączyć rezystor wstępny 1,8 W WZ 18-2/0 110 520 001 lub zastosować przewód rezystancyjny 1,8 W (seryjny lub jako doposażenie)  
177 Pojazdy z silnikiem 4-, 5-, 6- i 8-cylindrowym, rezystor wstępny 1,8 W WZ 18-2/0 110 520 001 (dołączony luzem) do doposażenia, dzięki temu poprawa zdolności rozruchu przy zimnym silniku  
180 bez opaski mocującej  
181 Pojazdy z silnikiem 4- i 6-cylindrowym, podłączyć rezystor wstępny 0,9 W WZ 09-2/0 110 510 008 lub zastosować przewód rezystancyjny 0,9 W (seryjny lub jako doposażenie)  
182 do silnika 2-cylindrowego i akumulatora 6 V (2 cewki zapłonowe podłączone jedna po drugiej po stronie uzwojenia pierwotnego)  
194 Przewód przyłączeniowy  
198 Asortyment w odniesieniu do producentów  
201 do elektronicznego układu zapłonowego  
202 ustalić w pojeździe  
207 indukcyjna  
208 Hall  
210 w przygotowaniu  
238 Przełożenie numeru części innych producentów → numer BERU  
263 zastąpiony  
279 Wtyczka przeciwzakłócenia do pojedynczych cewek zapłonowych  
280 Montaż z lewej strony  
281 Montaż z prawej strony  
282 ZS 052 wymieniać tylko parami

- 14 Σύστημα ανάφλεξης τρανζίστορ  
 19 Θερμομονωτικό έλασμα  
 20 μέχρι εξαντλήσεως των αποθεμάτων  
 42 κόκκινο  
 43 γκρι  
 51 Κινητήρας αερίου  
 52 Περονοφόρο ανυψωτικό όχημα  
 53 Ετικέτα κίτρινη  
 54 Ετικέτα πράσινη  
 55 Πηνίο ανάφλεξης για σύστημα ανάφλεξης τρανζίστορ  
 57 Ετικέτα γκρι  
 60 Διπλή ανάφλεξη  
 61 μόνο σε συνδυασμό με μπουζί NGK MAR10-A-J  
 62 Αντλία (πυροσβεστική)  
 63 Ανταλλακτικό  
 64 Κεφαλή πηνίου ανάφλεξης  
 65 Μήκος καλωδίου  
 66 2 τεμάχια ανά κύλινδρο  
 105 Νέα προϊόντα στον κατάλογο  
 106 Επισκόπηση κατά τύπο και κωδικό παραγγελίας  
 109 Κωδικοποίηση κωδ. παραγγελίας αρχικού εξοπλισμού (OE) → κωδ. παραγγελίας εμπορίου (AM)  
 112 Ανταλλακτικοί τύποι  
 117 Περίβλημα συνδετήρα κόκκινο  
 118 Περίβλημα συνδετήρα γκρι  
 119 Περίβλημα συνδετήρα καφέ  
 120 Περίβλημα συνδετήρα μαύρο  
 121 Περίβλημα συνδετήρα λευκό  
 122 2 x πηνία ανάφλεξης ZS 234 απαραίτητα για 8-κύλινδρους κινητήρες και Alfa Romeo Twin Spark (4-κύλινδρος)  
 123 με τελική βαθμίδα  
 125 για κινητήρες 1 και 2 κυλινδρών  
 126 Στήριγμα συναρμολόγησης για πηνία ανάφλεξης  
 127 χωρίς αύξηση τάσης εκκίνησης  
 128 με αύξηση τάσης εκκίνησης  
 129 δυνατότητα αύξησης τάσης εκκίνησης  
 130 Κύλινδρος  
 133 Πηνίο ανάφλεξης (μαύρο)  
 134 Πηνίο ανάφλεξης υψηλής απόδοσης, μπλε  
 135 Πηνίο ανάφλεξης υψηλής απόδοσης με αντιστάτη, πορτοκαλί  
 136 ασημί  
 137 Πηνίο ανάφλεξης για ανάφλεξη τρανζίστορ, μπλε  
 138 Πηνίο ανάφλεξης υψηλής απόδοσης, μαύρο  
 162 Κατά DIN 72531, με διεθνών προδιαγραφών σφικτήρα στερέωσης  
 170 Συνδέσεις  
 174 Οχήματα με 2-, 3-, 4-, 5-, 6-, 8-κύλινδρο κινητήρα, σύστημα ανάφλεξης χωρίς αρχική αντίσταση  
 176 Οχήματα με 4-, 5-, 6-, 8-κύλινδρο κινητήρα, συνδέστε αντίσταση σειράς 1,8 W WZ 18-2/0 110 520 001 ή χρησιμοποιήστε αγωγό αντίστασης 1,8 W (σειράς ή πρόσθετου εξοπλισμού)  
 177 Οχήματα με 4-, 5-, 6-, 8-κύλινδρο κινητήρα, αντίσταση σειράς 1,8 W WZ 18-2/0 110 520 001 (περιλαμβάνεται) για μετέπειτα τοποθέτηση, επιτυγχάνεται βελτίωση ψυχρής εκκίνησης  
 180 χωρίς σφικτήρα στερέωσης  
 181 Οχήματα με 4-, 6-κύλινδρο κινητήρα, συνδέστε αντίσταση σειράς 0,9 W WZ 09-2/0 110 510 008 ή χρησιμοποιήστε αγωγό αντίστασης 0,9 W (σειράς ή πρόσθετου εξοπλισμού)  
 182 για 2-κύλινδρο κινητήρα και μπαταρία 6-Volt (2 πηνία ανάφλεξης συνδεδεμένα διαδοχικά στην κύρια πλευρά)  
 194 Αγωγός σύνδεσης  
 198 Γκάμα προϊόντων του κατασκευαστή  
 201 για ηλεκτρονικό σύστημα ανάφλεξης  
 202 στο όχημα. Προσδιορισμός  
 207 επαγωγικά  
 208 Hall  
 210 σε προετοιμασία  
 238 Κωδικοποίηση εξαρτημάτων τρίτων κατασκευαστών → BERU  
 263 αντικαταστάθηκε  
 279 Συνδετήρας αποσφαλμάτωσης για επιμέρους πηνία ανάφλεξης  
 280 Τοποθέτηση αριστερά  
 281 Τοποθέτηση δεξιά  
 282 ZS 052 αντικατάσταση μόνο κατά ζεύγη
- 14 Τρανζίστορος γυújtóberendezés  
 19 Hóvédó lemez  
 20 Amíg a készlet tart  
 42 piros  
 43 címke  
 51 Gázmotor  
 52 Villás targonca  
 53 Sárga címke  
 54 Zöld címke  
 55 Gyújtótekercs tranzisztoros gyújtóberendezéshez  
 57 Szürke címke  
 60 Kettős gyújtás  
 61 Csak NGK MAR10-A-J gyújtógyertyával  
 62 Szivattyú (tűzoltóság)  
 63 Pótlás  
 64 Gyújtótekercsfej  
 65 Kábelhossz  
 66 2 darab hengerenként  
 105 Új a katalógusban  
 106 Típus és rendelési szám szerinti áttekintés  
 109 Átkódolás: eredeti minőséggel egyező gyártás megrendelési száma (OE) → kereskedelmi megrendelési szám (AM)  
 112 Póttípusok  
 117 Piros dugaszház  
 118 Szürke dugaszház  
 119 Barna dugaszház  
 120 Fekete dugaszház  
 121 Fehér dugaszház  
 122 8-hengeres motorokhoz és az Alfa Romeo Twin Spark-hoz (4-hengeres) 2 db ZS 234 tip. gyújtótekercs szükséges.  
 123 Végfokozattal  
 125 1-, 2-hengeres motorokhoz  
 126 Szerelési tartó gyújtótekercshez  
 127 Indítófeszültség-megemelés nélkül  
 128 Indítófeszültség-megemeléssel  
 129 Indítófeszültség-megemelés lehetséges  
 130 Henger  
 133 Gyújtótekercs (fekete)  
 134 Nagyteljesítményű gyújtótekercs, kék  
 135 Rezisztoros nagyteljesítményű gyújtótekercs, narancssárga  
 136 ezüst  
 137 Gyújtótekercs tranzisztoros gyújtáshoz, kék  
 138 Nagyteljesítményű gyújtótekercs, fekete  
 162 A DIN 72531 szerint, nemzetközi rögzítőbillinccsel  
 170 Csatlakozók  
 174 2-, 3-, 4-, 5-, 6-, 8-hengeres motorral rendelkező gépjárművek, előtét-ellenállás nélküli gyújtóberendezés  
 176 4-, 5-, 6-, 8-hengeres motorral rendelkező gépjárművek, 1,8 W-os WZ 18-2/0 110 520 001 ellenállást kell elé kötni vagy 1,8 W-os ellenállás-vezetékkel kell használni (sorozatkivétel vagy utólagos beszerelés)  
 177 4-, 5-, 6-, 8-hengeres motorral rendelkező gépjárművek, 1,8 W-os WZ 18-2/0 110 520 001 előtét-ellenállás (mellékelve) utólagos beszereléshez, javítja a hidegindítást  
 180 Rögzítőbillincs nélkül  
 181 4-, 6-hengeres motorral rendelkező gépjárművek, 0,9 W-os WZ 09-2/0 110 510 008 ellenállást kell elé kötni vagy 0,9 W-os ellenállás-vezetékkel kell használni (sorozatkivétel vagy utólagos beszerelés)  
 182 2-hengeres motorhoz és 6 V-os akkumulátorhoz (2 gyújtótekercs a primer oldalon egymás után kötve)  
 194 Csatlakozóvezeték  
 198 Gyártófüggő választékok  
 201 elektronikus gyújtóberendezéshez  
 202 a gépjárművön. Meghatározás  
 207 induktív  
 208 Hall  
 210 Előkészületben  
 238 Átkódolás: idegen alkatrészek → BERU  
 263 helyettesít  
 279 Zavarmentesítő dugasz egyedi gyújtótekercshez  
 280 Felszerelés balra  
 281 Felszerelés jobbra  
 282 ZS 052 csak párban cserélendő

- |     |  |     |  |
|-----|--|-----|--|
| 14  | Sistema de ignição por transístor  | 14  | Transistörli ateşleme sistemi  |
| 19  | Blindagem térmica  | 19  | Isı koruma sacı  |
| 20  | até esgotar o stock  | 20  | Stoklarla sınırlıdır   |
| 42  | vermelho   | 42  | kırmızı  |
| 43  | cinzenta   | 43  | Gri  |
| 51  | Motor a gás  | 51  | Gazlı motor  |
| 52  | Empilhador   | 52  | Forklift   |
| 53  | Etiqueta amarela   | 53  | Sarı etiket  |
| 54  | Etiqueta verde   | 54  | Yeşil etiket   |
| 55  | Bobina de ignição para sistema de ignição por transístor   | 55  | Transistörli ateşleme sistemi için ateşleme bobini   |
| 57  | Etiqueta cinzenta  | 57  | Gri etiket   |
| 60  | Ignição dupla  | 60  | Çift ateşleme  |
| 61  | só juntamente com vela de ignição NGK MAR10-A-J  | 61  | Sadece NGK MAR10-A-J bujiyle bağlantılı olarak   |
| 62  | Bomba (bombeiros)  | 62  | Pompa (itfaiye)  |
| 63  | Reposição  | 63  | Yedek  |
| 64  | Cabeça da bobina de ignição  | 64  | Ateşleme bobini kafası   |
| 65  | Comprimento de cabo  | 65  | Kablo uzunluğu   |
| 66  | 2 peças por cilindro   | 66  | Silindir başına 2 adet   |
| 105 | Novo no catálogo   | 105 | Katalogda yeni   |
| 106 | Visão geral segundo tipo e número de encomenda   | 106 | Tip ve sipariş numarasına genel bakış  |
| 109 | Nº de encomenda de equipamento original de conversão (OE)<br>→ Nº de encomenda comercial (AM)  | 109 | İlk donanım sipariş numarasının kodunun dönüştürülmesi (OE)<br>→ Ticari sipariş numarası (AM)  |
| 112 | Modelos de substituição  | 112 | Yedek tipler   |
| 117 | Caixa do conector vermelha   | 117 | Kırmızı soket muhafazası   |
| 118 | Caixa do conector cinzenta   | 118 | Gri soket muhafazası   |
| 119 | Caixa do conector castanha   | 119 | Kahverengi soket muhafazası  |
| 120 | Caixa do conector preta  | 120 | Siyah soket muhafazası   |
| 121 | Caixa do conector branca   | 121 | Beyaz soket muhafazası   |
| 122 | 2 x bobina de ignição ZS 234 necessária para motores de 8 cilindros e Alfa Romeo Twin Spark (4 cilindros)                                    | 122 | 8 silindirli motorlar ve Alfa Romeo Twin Spark (4 silindirli) için 2 x ZS 234 ateşleme bobini gereklidir   |
| 123 | com estágio final  | 123 | Çıkış katıyla birlikte   |
| 125 | para motores de 1 e 2 cilindros  | 125 | 1, 2 silindirli motorlar için  |
| 126 | Suporte de montagem para as bobinas de ignição   | 126 | Ateşleme bobini montaj tutucusu  |
| 127 | sem aumento de tensão de arranque  | 127 | Çalıştırma gerilimi yükseltmez   |
| 128 | com aumento da tensão de arranque  | 128 | Çalıştırma gerilimi yükseltmeli  |
| 129 | aumento da tensão de arranque possível   | 129 | Çalıştırma gerilimi yükseltmesi mümkündür  |
| 130 | Cilindro   | 130 | Silindir   |
| 133 | Bobina de ignição standard, preta  | 133 | Ateşleme bobini (siyah)  |
| 134 | Bobina de ignição de alto rendimento, azul   | 134 | Yüksek kapasiteli ateşleme bobini, mavi  |
| 135 | Bobina de ignição de alto rendimento com resistência, cor de laranja   | 135 | Rezistörli yüksek kapasiteli ateşleme bobini, turuncu  |
| 136 | prata  | 136 | gümüş  |
| 137 | Bobina de ignição para ignição por transístor, azul  | 137 | Transistörli ateşleme için ateşleme bobini, mavi   |
| 138 | Bobina de ignição de alto rendimento, preta  | 138 | Yüksek kapasiteli ateşleme bobini, siyah   |
| 162 | com braçadeira de fixação internacional  | 162 | DIN 72351'e göre, uluslararası sabitleme kelepçesi ile birlikte  |
| 170 | Ligaçao  | 170 | Bağlantılar  |
| 174 | Veículos com motores de 2, 3, 4, 5, 6 e 8 cil., sistema de ignição sem pré-resistência   | 174 | 2, 3, 4, 5, 6, 8 silindirli motora sahip araçlar, ön dirençsiz ateşleme sistemi  |
| 176 | veículos com motores de 4, 5, 6 e 8 cil., ligar pré-resistência de 1,8 Ω ou usar cabo de resistência de 1,8 Ω (de série ou de reequipamento) | 176 | 4, 5, 6, 8 silindirli motora sahip araçlar, 1,8 W direnç WZ 18-2/0 110 520 001 öne bağlanmalı veya 1,8 W direnç hattı kullanılmalıdır (standart veya ek donanım)           |
| 177 | veículos com motores de 4, 5, 6 e 8 cil., 1,8 Ω resistência auxiliar (incluída) para reequipamento, melhorando assim o arranque a frio       | 177 | 4, 5, 6, 8 silindirli motora sahip araçlar, donanım ekleme için 1,8 W -n direnç WZ 18-2/0 110 520 001 (pakette bulunur), bu sayede soğuk çalıştırma özelliği iyileştirilir |
| 180 | Bobina de ignição para motores de 1 e 2 cilindros sem braçadeira de fixação  | 180 | Sabitleme kelepçesiz   |
| 181 | veículos com motores de 4 e 6 cil., ligar pré-resistência de 0,9 Ω ou usar cabo de resistência de 0,9 Ω (de série ou de reequipamento)       | 181 | 4, 6 silindirli motora sahip araçlar, 0,9 W direnç WZ 09-2/0 110 510 008 öne bağlanmalı veya 0,9 W direnç hattı kullanılmalıdır (standart veya ek donanım)                 |
| 182 | para motores de 2 cil. e bateria de 6 Volt (2 bobinas de ignição primárias ligadas em série)   | 182 | 2 silindirli motor ve 6 Volt akü için (birincil tarafta 2 ateşleme bobini arka arkaya bağlanır)  |
| 194 | Cabo de ligação  | 194 | Bağlantı hatt çeşitler   |
| 198 | Sortidos ordenados por fabricantes   | 198 | Üreticiyi baz alan çeşitler  |
| 201 | para sistema de ignição electrónico  | 201 | Elektronik ateşleme sistemi için   |
| 202 | determinar a bobina de ignição correcta junto do veículo   | 202 | Araçta belirleyiniz  |
| 207 | indutivo   | 207 | Endüktif   |
| 208 | Hall   | 208 | Hall   |
| 210 | na preparação  | 210 | Hazırlık aşamasında  |
| 238 | Conversão peças de terceiros → BERU  | 238 | Başka üreticilerin parçalarını → BERU'ya kod dönüştürme  |
| 263 | substituído  | 263 | Değiştirildi   |
| 279 | Conector de protecção para bobinas de ignição individuais  | 279 | Tekli ateşleme bobinleri için parazit giderme bağlantısı   |
| 280 | Montagem à esquerda  | 280 | Sola montaj  |
| 281 | Montagem à direita   | 281 | Sağa montaj  |
| 282 | Substituir ZS 052 apenas aos pares   | 282 | ZS 052 sadece çift olarak değiştiriniz   |

## Federal-Mogul Product Warranty

The products listed in this catalog can be used in all vehicles/engines in accordance with our recommendation. Recognisable mistakes or obvious printing errors are subject to the diligence of the user. Federal-Mogul warrants the faultless performance and specified properties according to the respective standards of technology. If BERU products which are used in accordance with our recommendations are proven to have caused damage to an engine, we will cover the resulting costs of rectifying the damage in line with our Federal-Mogul Terms and Conditions of Sale which can be obtained from [www.federalmogul.com/en/AftermarketSolutions/EMEA](http://www.federalmogul.com/en/AftermarketSolutions/EMEA). Following submission of BERU products claimed to be defective as well as damaged engine parts and repair bills, we reserve the right to examine the claims and to decide based on the outcome of our analysis whether or not reimbursements will be made. Generally prerequisite is the correct use of the BERU products. The warranty period for material flaws or faulty workmanship is 24 months from the date of purchase. Normal wear and tear are excluded.

## Federal-Mogul Produktgewährleistung

Die in diesem Katalog aufgeführten Produkte können in allen Fahrzeugen/Motoren entsprechend unserer Empfehlung verwendet werden. Erkennbarer Irrtum oder offensichtliche Druckfehler unterliegen der Sorgfaltspflicht des Verwenders. Für die Fehlerfreiheit leistet Federal-Mogul Gewähr entsprechend dem jeweiligen Stand der Technik. Werden BERU Produkte gemäß unseren Empfehlungen verwendet und entstehen hierdurch trotzdem nachweisbare Schäden am Motor, übernehmen wir die entstandenen Kosten für die Behebung des Schadens gemäß den Federal-Mogul Geschäfts- und Lieferbedingungen. Die Allgemeinen Geschäfts- und Lieferbedingungen sind nachzulesen unter [www.federalmogul.com/en/AftermarketSolutions/EMEA](http://www.federalmogul.com/en/AftermarketSolutions/EMEA). Nach Vorlage beanstandeter BERU Produkte, beschädigter Motorenteile und Reparaturbelege trifft Federal-Mogul die Entscheidung über eine Kostenübernahme. Grundvoraussetzung dafür ist generell die sachgemäße Handhabung der BERU Produkte. Die Gewährleistungsfrist für mangelhafte Produkte beträgt 24 Monate ab Kaufdatum. Ausgenommen davon ist normaler Verschleiß.

## Garantie produit Federal-Mogul

Les produits figurant dans ce catalogue peuvent être utilisés dans tous les véhicules/moteurs selon nos recommandations. Les erreurs reconnaissables ou les erreurs d'impression évidentes tombent sous l'obligation d'attention de l'utilisateur. Federal-Mogul garantit l'absence d'erreurs et les propriétés annoncées sur la base de l'état de la technique existante. Lorsque les produits BERU sont utilisés conformément à nos recommandations et que, suite à cela, le moteur subit malgré tout des dommages pouvant être prouvés, nous supportons les coûts engendrés pour éliminer ces dommages en accord avec les conditions de vente de Federal-Mogul qui sont disponibles sur [www.federalmogul.com/en/AftermarketSolutions/EMEA](http://www.federalmogul.com/en/AftermarketSolutions/EMEA). Après présentation des produits BERU faisant l'objet d'une réclamation, des pièces de moteur endommagées et des factures de réparation, Federal-Mogul prend la décision concernant la prise en charge des coûts. La condition préalable fondamentale pour cela est en général l'utilisation conforme des produits BERU. La période de garantie de nos produits est de 24 mois à partir de la date d'achat. L'usure normale en est exclue.

## Гарантия на продукцию Federal-Mogul

Указанные в данном каталоге изделия могут использоваться во всех транспортных средствах/двигателях согласно нашим рекомендациям. Federal-Mogul не несет ответственности за явные недоразумения и опечатки, их обнаружение входит в обязанность пользователя. Federal-Mogul гарантирует безотказную работу изделий в соответствии со спецификациями и установленными стандартами существующих технологий. Если изделия BERU, несмотря на применение в соответствии с нашими рекомендациями, оказались подтвержденной причиной повреждения двигателя, Federal-Mogul возьмет на себя расходы по устранению повреждения в строгом соответствии с положениями Условий делового сотрудничества с Federal-Mogul. Данная информация доступна по ссылке [www.federalmogul.com/en/AftermarketSolutions/EMEA](http://www.federalmogul.com/en/AftermarketSolutions/EMEA). После предоставления изделий BERU с предположительным дефектом изготовления, а также поврежденных деталей двигателя и документов, подтверждающих выполнение ремонта, Federal-Mogul оставляет за собой право проанализировать претензии и принять решение на основании проведенного анализа о необходимости возмещения ущерба. Неотъемлемым условием признания гарантийного характера поломки является правильность применения изделий BERU. Гарантийный срок на повреждения, вызванные недостатками материала или качества изготовления, составляет 24 месяца с даты покупки изделия и не распространяется на нормальный износ.

## Federal-Mogul termékjótállás

Az ebben a katalógusban felsorolt termékek minden általunk javasolt járműben/ motorban használhatók. Felismerhető tévedések vagy nyilvánvaló nyomdahibák esetén, a felhasználók gondossági kötelezettsége érvényesül. A Federal-Mogul garantálja a hibamentes működést és a feltüntetett tulajdonságokat a mindenkori technika standardja szerint. Ha a BERU termékeket az ajánlásunknak megfelelően alkalmazzák és a motoron ennek ellenére bizonyítható meghibásodás lép fel, akkor teljes mértékben vagy részben átvesszük a hibák elhárításának a költségét a [www.federalmogul.com/en/AftermarketSolutions/EMEA](http://www.federalmogul.com/en/AftermarketSolutions/EMEA) weblapról letölthető Federal-Mogul Általános Üzleti Feltételek szerint. Kifogásolt BERU termékek, vagy meghibásodott motorrészek és javítási számlák felmutatása után, a Federal-Mogul jogosult azokat megvizsgálni majd dönt a költségek átvállalásáról. Ennek alapvető feltétele mindig a BERU termékek szakszerű használata. A hibás termékek miatti jótállási idő 24 hónap a beszerzéstől számítva. Kivételt képez ez alól a természetes elhasználódás.

## Garanzia sui prodotti Federal-Mogul

I prodotti contenuti nel presente catalogo possono essere utilizzati in tutti i veicoli/motori secondo le nostre raccomandazioni. I Federal-Mogul non risponde per errori di contenuto o di stampa palesi, il cui riconoscimento cade sotto la perizia dell'utilizzatore. Federal-Mogul garantisce l'integrità assicurata nell'ambito dei relativi standard tecnologici. Se è possibile comprovare che il motore ha subito danni nonostante che i prodotti BERU siano stati usati rispettando le nostre raccomandazioni, ci prendiamo carico parzialmente o totalmente delle spese causate per la riparazione del danno in linea con i termini e le condizioni di vendita Federal-Mogul reperibili dal sito [www.federalmogul.com/en/AftermarketSolutions/EMEA](http://www.federalmogul.com/en/AftermarketSolutions/EMEA). Federal-Mogul decide sul risarcimento dei danni dietro presentazione dei prodotti BERU reclamati, dei componenti del motore danneggiati e delle relative fatture, a condizione che i prodotti BERU siano stati manipolati correttamente. Come dalle nostre condizioni generali di contratto, la garanzia per prodotti difettosi è di 24 mesi, decorrenti dalla data dell'acquisto, ad eccezione di danni o difetti causati da normale usura.

## Federal-Mogul Garantía de producto

Los productos incluidos en este catálogo, deben utilizarse en los vehículos / motores según y conforme las recomendaciones descritas en la aplicación. Los errores identificables o posibles faltas de impresión evidentes, quedan sujetas al examen esmerado por parte del usuario. Federal-Mogul garantiza el funcionamiento sin fallos y especifica las propiedades de sus productos de acuerdo con los respectivos estándares tecnológicos establecidos. Si en el uso y aplicación de los productos BERU, conforme a las recomendaciones especificadas, surgen daños demostrables en el motor, la empresa asumirá total o parcialmente los costes de los efectos de la avería, en línea con las condiciones y términos de venta establecidos por Federal-Mogul, disponibles en: [www.federalmogul.com/en/AftermarketSolutions/EMEA](http://www.federalmogul.com/en/AftermarketSolutions/EMEA), y tras el análisis de las causas aportadas en la reclamación, piezas dañadas y comprobantes de la reparación. La compañía resolverá la decisión sobre la aceptación de los costes de la avería. Condición básica para ello es por norma el tratamiento técnicamente correcto de los productos BERU. El plazo de garantía sobre productos defectuosos es de 24 meses , desde la fecha de adquisición, Se exceptúa de ello el desgaste previsto del uso normal del producto.

## Ἐγγύηση προϊόντων Federal-Mogul

Τα προϊόντα, τα οποία αναφέρονται στον κατάλογο αυτό, μπορούν να χρησιμοποιηθούν σε όλα τα οχήματα/κινητήρες σύμφωνα με τη σύστασή μας. Ἐναγνωσηρίσµα λάθη, ή φροσφνή τυπογραφικά λάθη ὑπόκεινται στην ἐπιμέλεια του χρήστη. Η Federal-Mogul ἐγγυάται την αλόδνθσση απόδοσή της ἐκάστοτε ἰδιοπερόητες σύμφωνα με τις αντίστοιχες τεχνολογικές προδιαγραφές. Σε περίπτωση που αποδεχόμενα προκληθούν ζημιές στον κινητήρα, παρά το γεγονός ότι η χρήση των προϊόντων BERU έγινε σύμφωνα με τις συστάσεις μας, θα καλύψουμε τις προκύπτουσες δαπάνες για την αποκατάσταση της ζημίας, όπως ορίζεται από τους όρους και τις προϋποθέσεις πώλησης των προϊόντων της Federal-Mogul στο [www.federalmogul.com/en/AftermarketSolutions/EMEA](http://www.federalmogul.com/en/AftermarketSolutions/EMEA). Ἐατόπιν ἐπίδειξη των ελαττωματικών προϊόντων BERU, των εξαρτημάτων κινητήρα με εμφανή ζημία και των αποδεικτικών επισκευές, διατηρούμε το δικαίωμα να εξετάσουμε τις εκάστοτε αξιώσεις και να αποφασίσουμε βασίζομενοι στην έκβαση της ανάλυσής μας εάν οι αποζημιώσεις θα πραγματοποιηθούν ή όχι. Η περίοδος της ἐγγύησης για ελαττωματικά προϊόντα ἀνέρχεται σε 24 μήνες από την ημερομηνία της αγοράς .Φυσιολογικές φθορές λόγω χρήσεις αποκλείονται.

## Federal-Mogul Ürün Garantisi

Bu katalogta belirtilen ürünler, yaptığımız öneriye göre tüm araçlar/motordlarda kullanılabilir. Belirlenebilen hatalar veya açık baskı hataları, kullanicinin özenli davranma yükümlülüğüne tabidir. Federal-Mogul, hatasızlık konusunda mevcut teknolojijk düzeyine uygun olarak garanti vermektedir. BERU ürünleri önerilerimize göre kullanılırsa ve buna rağmen motorda ispatlanbinde hasarlar oluşursa, hasarın giderilmesi için oluşan masrafları Federal-Mogul'un Satış Koşulları çerçevesinde tamamen veya kısmen üstlenmekteyiz. Daha fazla bilgi için [www.federalmogul.com/en/AftermarketSolutions/EMEA](http://www.federalmogul.com/en/AftermarketSolutions/EMEA) sitesini ziyaret ediniz. Şikayet konusu BERU ürünlerini, hasarlı motor parçalarını ve onarım belgelerini belgelenmesinden sonra, masrafları üstlenmek konusunda karar verilir. Bunun önkoşulu, genel olarak BERU ürünlerini usulüne uygun şekilde kullanılmasıdır. Kusurlu ürünler için garanti süresi, genel çalışma koşullarımız saltna tarihinden itibaren 24 aydır. Normal aşınma ve yıpranma bunun dışındadır.

## Gwarancja na produkty Federal-Mogul

Wymienione w niniejszym katalogu produkty mogą być stosowane we wszystkich pojazdach/silnikach zgodnie z naszymi zaleceniami. W ramach obowiązku należytęj staranności użytkownika znajduję się wykluczenie dostrzegalnych pomyłek lub widocznych błędów w druku. Firma Federal-Mogul udziela gwarancji na bezusterkowe działanie oraz dotrzymanie deklarowanych właściwości produktów, zgodnie z odpowiednimi standardami technologicznymi. Jeżeli produkty BERU będą stosowane zgodnie z naszymi zaleceniami i pomimo tego dojdzie do dających się udowodnić uszkodzeń silnika, wówczas pokryjemy koszty wynikające z naprawy tych uszkodzeń zgodnie z naszymi Warunkami Sprzedaży, które są dostępne na stronie internetowej: [www.federalmogul.com/en/AftermarketSolutions/EMEA](http://www.federalmogul.com/en/AftermarketSolutions/EMEA) . Po przedłożeniu reklamowanych produktów BERU, a także ewentualnych uszkodzonych części silnika oraz rachunków potwierdzających koszty dokonanych napraw, zastrzegamy sobie prawo do zbadania reklamowanych produktów i na podstawie wyników naszych badań i analiz zdecydowania, czy zwrot kosztów naprawy będzie miał miejsce. Podstawowym warunkiem jest prawidłowe użycie produktów BERU. Okres gwarancji na wady materiałowe i błędy produkcyjne wynosi 24 miesiące od daty zakupu. Gwarancja nie obejmuje zużycia produktu w wyniku eksploatacji.

## Federal-Mogul productgarantie

De in deze catalogus vermelde producten kunnen in alle voertuigen/motoren, mits in overeenstemming met onze aanbevelingen, worden toegepast. Het herkennen van- en het op de juiste wijze omgaan met duidelijk als dusdanig herkenbare vergissingen of drukfouten vallen onder de verantwoordelijkheid van de gebruiker. Federal-Mogul staat garant voor het correct functioneren in overeenstemming met de respectieve stand van de techniek. Als BERU-producten die volgens onze aanbevelingen worden gebruikt, aantoonbaar tot schade aan een motor hebben geleid, worden de kosten voor herstel vergoed op basis van de algemene voorwaarden van Federal-Mogul (zie [www.federalmogul.com/en/AftermarketSolutions/EMEA](http://www.federalmogul.com/en/AftermarketSolutions/EMEA)). Na het overleggen van de bekritiseerde BERU producten, beschadigde motoronderdelen en reparatiefacturen, houden wij ons het recht voor om de claim te onderzoeken en op basis daarvan te besluiten of er een vergoeding wordt verstrekt. Een eerste vereiste daarvoor in het algemeen is het deskundige gebruik van de BERU producten. De garantietermijn voor materiaal- of fabricagefouten bedraagt 24 maanden, op basis van onze algemene voorwaarden en vanaf de datum van aanschaf. Uitgezonderd daarvan is normale slijtage en ondeskundig gebruik.

© Federal-Mogul Global Aftermarket EMEA bvba  
All rights reserved. Duplicating, microfilming or storing and processing in electronic systems is not permitted without prior written consent.

© Federal-Mogul Global Aftermarket EMEA bvba  
Alle Rechte vorbehalten. Vervielfältigung, Mikroverfilmung und die Einspeicherung und Verarbeitung in elektronischen Systemen ist ohne vorherige schriftliche Zustimmung verboten.

© Federal-Mogul Global Aftermarket EMEA bvba  
Tous droits réservés. Duplication, microfilm ou stockage et traitement dans les systèmes électroniques est interdite sans autorisation écrite préalable.

© Federal-Mogul Global Aftermarket EMEA bvba  
Все права защищены. Запрещается копирование, микросъемка, хранение и обработка приведенной информации в электронном виде без предварительного письменного разрешения Federal-Mogul.

© Federal-Mogul Global Aftermarket EMEA bvba  
Minden jog, fenntartva. Másolás, mikrofilmre vitele vagy tárolás és elektronikus rendszerben felhasználása előzetes írásos engedély nélkül tilos.

© Federal-Mogul Global Aftermarket EMEA bvba  
Tutti i diritti riservati. Duplicare, filmare o archiviare elettronicamente per rielaborare i contenuti non è permesso senza la preventiva autorizzazione rilasciata per iscritto.

© Federal-Mogul Global Aftermarket EMEA bvba  
Todos los derechos reservados. Cualquier duplicado, microfilmación o reproducción digital queda explícitamente prohibida sin previa autorización escrita

© Federal-Mogul Global Aftermarket EMEA bvba  
Όλα τα δικαιώματα προστατεύονται. Η αναπαραγωγή, η φωτογράφιση σε μικροφίλμ ή η αποθήκευση και η επεξεργασία σε ηλεκτρονικά συστήματα δεν επιτρέπονται χωρίς προηγούμενη γραπτή συγκατάθεση.

© Federal-Mogul Global Aftermarket EMEA bvba  
Tüm hakları saklıdır. Çoğaltma, kopyalama, elektronik sistemlerde kaydetme ve işletmeye yazılı onay bulunmadığı sürece izin verilmemektedir.

© Federal-Mogul Global Aftermarket EMEA bvba  
Wszystkie prawa zastrzeżone. Powielanie, wykonywanie mikrofilmów lub przechowywanie i przetwarzanie w systemach elektronicznych nie jest dozwolone bez uprzedniej pisemnej zgody.

© Federal-Mogul Global Aftermarket EMEA bvba  
Alle rechten voorbehouden. Verviëlvoucligen, op microfilm vastleggen of opslaan en verwerken in elektronische systemen is niet toegestaan zonder voorafgaande schriftelijke toestemming.

# Perfection built in Perfektion eingebaut



Perfection intégrée

Perfezione integrata

Perfección integrada

Mükemmel tasarım

Perfectie ingebouwd

Perfeiçãoinata

Совершенство высоких технологий

Perfekcja rozwiązań

Beépített mestermű

Ολοκληρωμένη τελειότητα



Bestell-Nr. 5 000 004 016  
BERU® is a Registered Trademark of BorgWarner BERU Systems GmbH  
CATBU1304

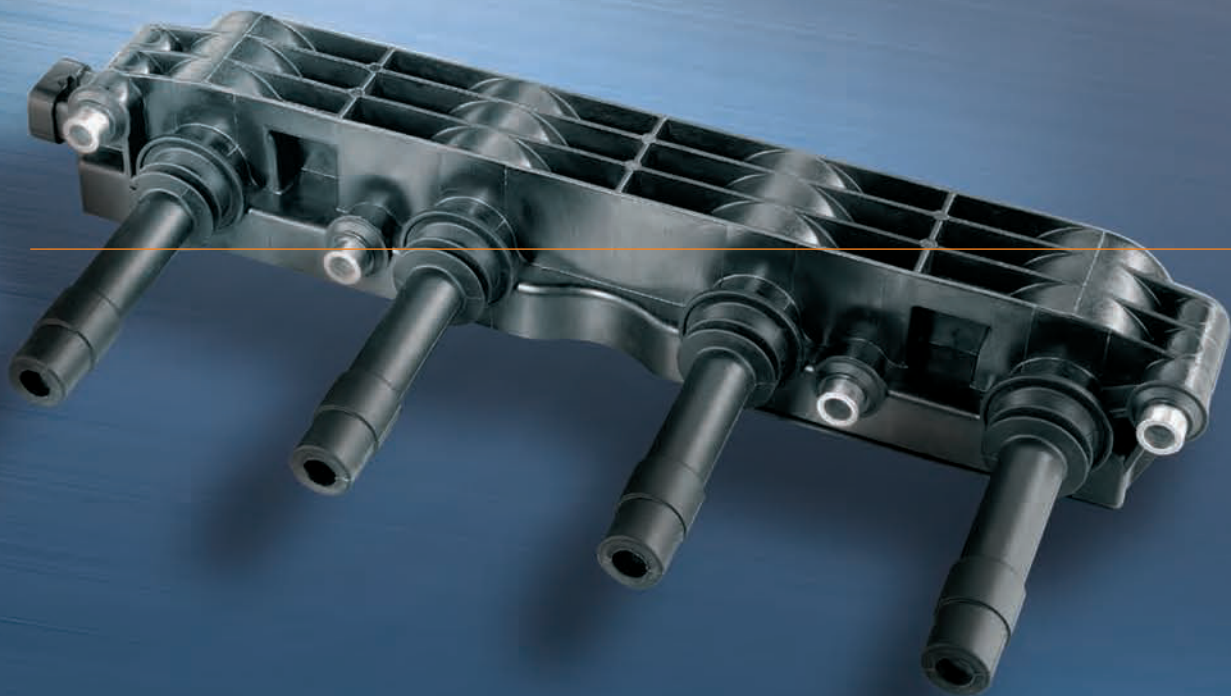

 **FEDERAL  
MOGUL**

Global Aftermarket EMEA bvba  
Prins Boudewijnlaan 5  
2550 Kontich • Belgium

[www.federalmogul.com](http://www.federalmogul.com)  
[beru.federalmogul.com](http://beru.federalmogul.com)

[beru@federalmogul.com](mailto:beru@federalmogul.com)

 [www.fmecat.eu](http://www.fmecat.eu)

Perfection  
built in

